

WHAT'S NEW



ELECTRICAL TERMINAL REPAIR PACK



A generous assortment of aviation grade ring and butt terminals. Perfect for field repairs. Meets MS-25036, and SAE AS7928 standards.

- 10 Butt splices 18-22 AWG
- 8 Butt splices 14-16 AWG
- 6 Butt splices 10-12 AWG
- 32 Ring terminals #4, #6, #8, #1018-22 (Red) AWG
- 24 Ring terminals #6, #8, #10, 1/4 14-16 (Blue) AWG
- 16 Ring terminals #8, #10, 1/4, 5/16 10-15 (Yellow) AWG

AVT-RK \$49.95

ATS SAFETY WIRE KIT



A money-saving kit from ATS. Included is our ATS 6" Safety Wire Twisters, the Hand Safety Wire Twister (134-8" long) for getting into those tight areas, quantity 3 1lb. cans of Safety Wire 302-25, 302-32, 302-41, and an 11" Canvas Tool Bag.

SWK-7R (6" Reversible Twister 6WR) \$85.95

SWK-7 (6" Non-Reversible Twister 6WA) \$65.95

AVERY RV-14 ELEVATOR BUCKING BAR



This special designed bucking bar is required on the Van's Aircraft RV-10 and RV-14 for riveting inside the elevators. The bar dimensions are called out in the RV builders plans pages 9-12 of the control surface section. The bar measures 1" wide X 3/4" tall X 14" long. Both ends of the bar have machined angles per the plans – one end has a "V" double angle, and the other end has a single angle. Both ends are used for separate riveting tasks in the airplane kit.

AE630 \$39.95

AVIATION GRADE ELECTRICAL TERMINALS



Aircraft grade electrical terminals meet Military and Aerospace MS-25036 Class 1, and SAE AS7928, Type II, Class 1 and 2 standards. They feature a brass sleeve for additional strength to protect against stress and vibration damage. The nylon insulation sleeve is rated to 300V and temperatures up to 105 °C.

PART NUMBER	AWG	POST SIZE	PRICE
RING TERMINALS (25EA PER PACK)			
AVT1822R-4PK	18-22	#4	\$7.95
AVT1822R-6PK	18-22	#6	\$6.95
AVT1822R-8PK	18-22	#8	\$7.95
AVT1822R-10PK	18-22	#10	\$7.95
AVT1822R-1/4PK	18-22	1/4	\$7.95
AVT1416R-4PK	14-16	#4	\$6.95
AVT1416R-6PK	14-16	#6	\$6.95
AVT1416R-8PK	14-16	#8	\$6.95
AVT1416R-10PK	14-16	#10	\$6.95
AVT1416R-1/4PK	14-16	1/4	\$6.95
AVT1416R-5/16PK	14-16	5/16	\$8.95
AVT1416R-3/8PK	14-16	3/8	\$8.95
AVT1012R-6PK	10-12	#6	\$10.95
AVT1012R-8PK	10-12	#8	\$10.95
AVT1012R-10PK	10-12	#10	\$10.95
AVT1012R-1/4PK	10-12	1/4	\$11.95
AVT1012R-5/16PK	10-12	5/16	\$11.95
AVT1012R-3/8PK	10-12	3/8	\$12.95
BUTT SPLICES (10EA PER PACK)			
AVT1822BSK	18-22 AWG		\$8.95
AVT1416BSK	14-16 AWG		\$6.95
AVT1012BSK	10-12 AWG		\$11.95

ROTAX ENGINE THREAD CHASER



ATS 12MM spark plug thread cleaning chasers are exactly what you need to clean both the spark plug and port threads of your Rotax Engine. It features a threaded end that is specially designed to clean the threads of your spark plug holes.

ATS487E \$29.95

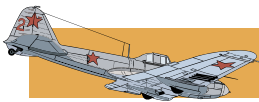

WHAT'S NEW

EVERY CUB CRAFTERS DRILL JIG KIT



This drill jig is highly recommended for safely and accurately drilling the rib attach holes in the Cub Crafter wing spars by the builder. The drill jig is precision machined aluminum with all dimensions per the print supplied with the builders manual. The drill jig has (2) hardened steel drill bushings – one # 40 drill bushing & (1) # 30 drill bushing. The drill jig has a blue anodized finish, and includes (2) # 40 & (2) # 30 cobalt drill bits + a stick of Boelube dry drilling lubricant.

AE1145.....\$95.95

EVERY 12" BACK RIVET SET



These extended versions of Back Rivet Sets are great to get into confined areas, They are especially useful to RV-10 builders who must back rivet some areas of the fuselage. 12" long straight, .401 shank

AE4560.....(Straight).....\$35.95

AE4653.....(Double Offset).....\$45.95

GROMMET STRETCHER



Stop cutting your grommets to get them over fittings and plugs, use Bogert Aviation's Grommet Stretcher. Using the Grommet Stretcher is 2-3x's faster when stretching grommets over fittings and plugs. It also improves safety because grommets are continuous. Great for spark wires or Molex plugs. Effective for use in many aviation, automotive, industrial, and marine applications.

BO-05M-GS.....\$37.95

EVERY HAND SQUEEZER



In 1993 Avery Tools pioneered and developed the unique design of the first hand rivet squeezer that had inter-changeability between the yokes for pneumatic squeezers. The squeezer comes with two quick release pins for faster and easier yoke changes, and handles that are 2" longer allowing for more leverage. This squeezer has molded grips to help prevent slippage and hand fatigue allowing you to squeeze between 3/32" to 1/8".

AE9430.....(3" Yoke).....\$315.95

AE9415.....(1.5" Yoke).....\$289.95

AE9400.....(Handles Only).....\$179.95

EVERY RV-14 MODIFIED #40 COUNTERSINK



On page 9-99 of the RV14 plans, between #6 & #7 there is a NOTE to taper the pilot of a #40 countersink cutter per figure 4 to aid in the countersinking of the holes in the angled trailing edge wedge. We now offer a #40 countersink cutter with the pilot precision ground to an angle per the plans.

AE14-1051M.....\$15.95

LEM HAND RIVENUT TOOL



Unit is simple to use and an efficient means for installing rivenuts. Unit comes with allen wrench.

PART NUMBER	SIZE	PRICE
L845-1/4-20	1/4-20	\$45.95
L845-1/4-28	1/4-28	\$45.95
L845-10/24	10-24	\$45.95
L845-10/32	10-32	\$45.95
L845-4/40	4-40	\$45.95
L845-6/32	6-32	\$45.95
L845-8/32	8-32	\$45.95





AVIONICS MAINTENANCE KIT



QTY	PART	DESCRIPTION	QTY	PART	DESCRIPTION
1	19000	19" TOOL BOX	1	B22	INSPECTION MIRROR
1	10-935	1/4" SPEED HANDLE	1	C79H	9" CRESCENT WRENCH
1	10937	ALLEN WRENCH SET 13PC	1	CE-0275	5PC PIN EXTRACTOR SET
1	18431	8" NEEDLE NOSE PLIERS	1	E200-003	AUTOMATIC WIRE STRIPPER
1	45239	DUAL WALL HEAT SHRINK TUBING	1	E200-058	4.5" DIAGONAL CUTTER
1	5X634	DIAGONAL CUTTERS	1	E300-015	D-SUB CLOSED BARREL CRIMPER
1	53167	6PC SCREW DRIVER SET	1	E300-039	OPEN BARREL AWG 10-20 CRIMPER DIE
1	6LN	WISE-GRIP PLIERS	1	E300-038	COAX TERMINALS CRIMPER DIE
1	6WR	6" REVERSIBLE SAFETY WIRE PLIERS	1	E500-037	TERMINAL CRIMP KIT
1	700	5PC MINI SCREWDRIVER SET	1	E900-065	INSERTION/EXTRACTION TOOL
1	7210	TAPE MEASURE	1	E900-181	6" STRAIGHT FORCEPS
1	7459	SOLDERING PASTE	1	E900-222	6" CURVED FORCEPS
1	7971	PRO BUTANE SOLDERING IRON	1	MT-1280	20 AMP MULTIMETER
1	80313	26PC 12PT SOCKET KIT	1	VT001-5	MINI VAMPLIERS
1	93813	1/4"X3/8" APEX BIT HOLDER	1	15530	BALL PEEN HAMMER
1	AT508K	CANNON PLUG PLIERS	1	48445	7PC NUT DRIVER KIT
1	2078606	6" ADJUSTABLE WRENCH	1	2089100	UTILITY FOLDING KNIFE
1	2078608	8" ADJUSTABLE WRENCH			

Our new Avionics Maintenance Kit has all of the essential tools to work on every aspect of aircraft electronics systems. Whether it's a simple electrical repair or a complete system rewire, you'll find this kit indispensable in getting the job done quickly and professionally.

AVK-01 **\$849.95**





KITS

ENGINE SPECIALIST KIT



QTY	PART	DESCRIPTION	QTY	PART	DESCRIPTION
1	SPCT100A	SPARK PLUG CLEANER TESTER	1	2EM	DIFFERENTIAL PRESSURE TESTER W/ MASTER ORIFICE
1	12	SPARK PLUG CLEANER	1	2E-WARRANTY	5 YEAR CALIBRATION CERTIFICATE
1	20200	SPARK PLUG HOLE THREAD CHASER	1	18MM-XT	COMPRESSION TESTER EXTENSION
1	ATS2612	ATS SPARK PLUG THREAD LUBRICANT	1	AE81031	AVERY OIL FILTER CUTTER
1	ATS415K	SPARK PLUG GAPPER AND GAP GAUGE	1	AA472	OIL FILTER TORQUE WRENCH
1	ATS950	ATS MAGNETIC SPARK PLUG SOCKET	1	E25	EASTERN TIMING INDICATOR
1	DV980-10	SPARK PLUG MAGNIFIER	1	LED52	DUAL TONE MAGNETO SYNCHRONIZER
1	FAP-12	SPARK PLUG TRAY	1	E5	EASTERN CABLE TESTER
1	M674HD	100 PC CHAMPION SPARK PLUG GASKETS	2	ML20	BENDIX MAGNETO LOCK TOOL
1	PA01	SPARK PLUG VIBRATOR CLEANER	2	T118	SLICK MAGNETO LOCK TOOL
1	ATS485	TERMINAL LEAD THREAD CHASER 3/4"	1	8768	P-LEAD ADAPTERS COMPLETE SET
1	ATS486	TERMINAL LEAD THREAD CHASER 5/8"	1	7500	PISTON RING COMPRESSOR SET
1	ATS483	SPARK PLUG GAP EXPANSION TOOL	1	1723	PISTON RING INSTALLER
1	ATS420	SPARK PLUG GAPPER	1	3882-5	CYLINDER BASE WRENCH SET
1	ATS482	SPARK PLUG EROSION GAUGE	1	6494-SET	LYCOMING INTERNAL HEX WRENCH SET
1	6061B	SAFETY WIRE DRILL GUIDE	1	302-32	SAFETY WIRE
1	SPCT100-COVER	SPARK PLUG CLEANER TESTER COVER	1	6WR	REVERSIBLE 6" SAFETY WIRE PLIERS
1	TC320	ENGINE CAP PROTECTORS	1	CB21-17	17" CANVAS BAG

ESK-01 \$1,799.95





JOURNEYMAN BUILDER'S KIT



QTY	PART	DESCRIPTION	QTY	PART	DESCRIPTION	QTY	PART	DESCRIPTION
1	ATS-XX	ATS PRO RIVET GUN	1	133	ADJUSTABLE MICROSTOP	1	ATS6100	ATS PALM DRILL
1	KMC-1022	HOMARK 22" TOOL BOX	1	1000-100-40	PILOT CUTTER (3/32)	1	DS-40	DRILL STOP (3/32)
1	1824	AIR REGULATOR	1	1000-100-30	PILOT CUTTER (1/8)	1	DS-30	DRILL STOP (1/8)
1	470-3-3/32	RIVET SET (AN470, 3/32")	1	1000-100-21	PILOT CUTTER (5/32)	1	DS-21	DRILL STOP (5/32")
1	470-3-1/8	RIVET SET (AN470, 1/8")	1	1000-100-12	PILOT CUTTER (3/16)	1	DS-12	DRILL STOP (3/16)
1	470-3-5/32	RIVET SET (AN470, 5/32")	1	4703-2	SQUEEZER SET (3/32")	1	61	STRAP DUPLICATOR (3/32)
1	470-3-3/16	RIVET SET (AN470, 3/16")	1	4704-2	SQUEEZER SET (1/8")	1	62	STRAP DUPLICATOR (1/8)
1	0470-3-3/32	OFFSET RIVET SET (3/32")	1	4705-2	SQUEEZER SET (5/32")	1	63	STRAP DUPLICATOR (5/32")
1	0470-3-1/8	OFFSET RIVET SET (1/8")	1	4706-2	SQUEEZER SET (3/16")	1	65	STRAP DUPLICATOR (3/16)
1	0470-3-5/32	OFFSET RIVET SET (5/32")	1	4710-2	SQUEEZER SET (FLUSH 1/2")	1	ATB8362	STANDARD AIRCRAFT BOOK
1	0470-3-3/16	OFFSET RIVET SET (3/16")	1	3710-2	SQUEEZER SET (FLUSH 3/8")	1	A601	ANGLE DRILL ATTACHMENT
1	750	FLUSH RIVET SET	1	3456-B	DIMPLE DIE ORGANIZER	1	A604	CLOSE QUARTER CHUCK
1	12A	RUBBERGUARD SET (1")	1	HS144	HAND SEAMER	1	64823	HAND NIBBLER
1	142	BUCKING BAR	1	FP10	FLUTING PLIERS	1	ATSMV01	PRO MINI VACUUM
1	147	BUCKING BAR	1	SP2005K	CHIP CHASERS (2.5" & 6")	1	M1R	AVIATION SNIP LEFT
1	148	BUCKING BAR	1	012-C60N	NUMBER COBALT DRILLBIT SET	1	M2R	AVIATION SNIP RIGHT
1	149	BUCKING BAR	1	5000-40	THREADED DRILL BIT (40)	1	M3R	AVIATION SNIP STRAIGHT
25	CL-3/32	CLECOS (3/32")	1	5000-30	THREADED DRILL BIT (30)	5	KWN-3/32	WINGNUT FASTENER (3/32")
25	CL-1/8	CLECOS (1/8")	1	5000-21	THREADED DRILL BIT (21)	5	KWN-1/8	WINGNUT FASTENER (1/8")
25	CL-5/32	CLECOS (5/32")	1	5000-12	THREADED DRILL BIT (12)	5	KWN-5/32	WINGNUT FASTENER (5/32")
25	CL-3/16	CLECOS (3/16")	1	ATRSR-1	1" RIVET SQUEEZER	5	KWN-3/16	WINGNUT FASTENER (3/16")
4	26EL	SIDE GRIP FASTENER 1"	1	ATRSR-3Y	3" RIVET SQUEEZER YOKE	1	130HD	RIVET CUTTER
4	24EL	SIDE GRIP FASTENER 1/2"	1	131	CLECO PLIERS			

Our Journeyman kit is for the aspiring A&P Mechanic, or Homebuilder, who needs a comprehensive professional kit, but is not yet ready for a Master Kit. It contains a broad selection of tools used frequently by Airframe Mechanics at an affordable price.

- JBK-2602A**(With 2602A Economy 3X Rivet Gun) **\$1,085.95**
- JBK-2X** (With ATS Pro 2X Rivet Gun) **\$1,089.95**
- JBK-3X** (With ATS Pro 3X Rivet Gun) **\$1,095.95**
- JBK-4X** (With ATS Pro 4X Rivet Gun) **\$1,099.95**





KITS

AIRFRAME MECHANICS KIT



QTY	PART	DESCRIPTION	QTY	PART	DESCRIPTION	QTY	PART	DESCRIPTION
1	ATS-XX	ATS PRO RIVET GUN	1	133	ADJUSTABLE MICROSTOP	1	ATS6101	3/8" AIR DRILL
1	1824	AIR REGULATOR	1	1000-100-40	PILOT CUTTER (3/32)	1	DS-40	DRILL STOP (3/32)
1	470-3-3/32	RIVET SET (AN470, 3/32")	1	1000-100-30	PILOT CUTTER (1/8)	1	DS-30	DRILL STOP (1/8)
1	470-3-1/8	RIVET SET (AN470, 1/8")	1	1000-100-21	PILOT CUTTER (5/32)	1	DS-21	DRILL STOP (5/32")
1	470-3-5/32	RIVET SET (AN470, 5/32")	1	1000-100-12	PILOT CUTTER (3/16)	1	DS-12	DRILL STOP (3/16)
1	470-3-3/16	RIVET SET (AN470, 3/16")	1	302-32	SAFETY WIRE (.032)	1	61	STRAP DUPLICATOR (3/32)
1	470-3-1/4	RIVET SET (AN470, 1/4")	1	FP21	FLUTING PLIERS	1	62	STRAP DUPLICATOR (1/8)
1	0470-3-3/32	OFFSET RIVET SET (3/32")	1	64823	HAND NIBBLER	1	63	STRAP DUPLICATOR (5/32")
1	0470-3-1/8	OFFSET RIVET SET (1/8")	1	SP2005	CHIP CHASER (6")	1	65	STRAP DUPLICATOR (3/16)
1	0470-3-5/32	OFFSET RIVET SET (5/32")	1	SP2005S	CHIP CHASER (2.5")	1	ATB8362	STANDARD AIRCRAFT BOOK
1	0470-3-3/16	OFFSET RIVET SET (3/16")	1	18431	NEEDLE NOSE PLIERS	1	5000-40	THREADED DRILL BIT (40)
1	0470-3-1/4	OFFSET RIVET SET (1/4")	1	18627	LINEMANS PLIERS	1	5000-30	THREADED DRILL BIT (30)
1	750	FLUSH RIVET SET	1	2078308	WISE GRIP CUTTING PLIER	1	5000-21	THREADED DRILL BIT (21)
1	12A	RUBBERGUARD SET (1")	1	10-935	1/4" DRIVE SPEED HANDLE	1	5000-12	THREADED DRILL BIT (12)
1	142	BUCKING BAR	1	3539	3" HI-LOCK INSTALLER	1	6WR	6" REV. WIRE TWISTER
1	147	BUCKING BAR	1	36021	SWIVEL RIVETER	1	AT540A-KIT	SCREW AND BOLT REMOVER
1	148	BUCKING BAR	1	575-50A	3/8" X 50' HOSE	1	ATS5101	STRAIGHT MINI DIE GRINDER
1	149	BUCKING BAR	1	53167	SCREWDRIVER SET	1	ATS5105	90° MINI DIE GRINDER
13	CL-3/32	CLECOS (3/32")	1	6LN	WISE-GRIP PLIERS	1	ATS6131	45° ANGLE AIR DRILL
13	CL-1/8	CLECOS (1/8")	1	7210	TAPE MEASURE	1	ATS6132	90° ANGLE AIR DRILL
12	CL-5/32	CLECOS (5/32")	1	7R	WISE GRIP PLIER	1	ATS8806	AIR HYDRAULIC RIVETER
12	CL-3/16	CLECOS (3/16")	1	80313	12PT STANDARD&DEEP SOCKET	1	ATSMV01	MINI VACUUM
1	131	CLECO PLIERS	1	85599	OPEN END WRATCHING SET	1	04995N	10" HALF ROUND BASTARD FILE
1	130HD	RIVET CUTTER	1	93813	1/4"X3/8" APEX BIT HOLDER	1	09179	10" MILL BASTARD
1	B22	INSPECTION MIRROR	1	CB21-17	17" CANVAS TOOL BAG	1	12019	10" ROUND BASTARD
1	C711H	11" AUTO WRENCH	1	EZ6	6" RULER	1	M1R	AVIATION SNIP LEFT
1	13196	10" SQUARE BASTARD FILE	1	21455	8" FILE CARD	1	M2R	AVIATION SNIP RIGHT
1	14290M	8" SLIM TRIANGULAR FILE	5	21474H	FILE HANDLE	1	M3R	AVIATION SNIP STRAIGHT
1	GT148	8" CALIPER	1	PL25	MINI-FLUORESCENT LIGHT			
1	CB-S9	ROTARY BURR SET	1	RLP2	ROLOC DISC PAD 2"			
1	S35P	SCREW EXTRACTOR SET	1	RLP3	ROLOC DISC PAD 3"			
1	SG94	SCREW GRAB	1	SPC75	PIN PUNCH SET			
1	81924	14PC WRENCH SET	1	15530	BALL PEEN HAMMER			

This kit was designed at the request of several FBO's and repair stations who desire their new hires to have a standard set of airframe tools that would allow them to do their required tasks. It features a set of common hand tools such as screwdrivers, hammers, and wrenches; as well as the more aviation specific tools such as a rivet gun, angle drill and die grinders.

AMK-2602A	(With 2602A Economy 3X Rivet Gun)	\$1,985.95
AMK-2X	(With ATS Pro 2X Rivet Gun)	\$1,989.95
AMK-3X	(With ATS Pro 3X Rivet Gun)	\$1,995.95
AMK-4X	(With ATS Pro 4X Rivet Gun)	\$1,999.95



RIVETING KITS



DELUXE RIVETING KIT

We added \$100 more value to our popular 150 piece kit, and lowered the price to give you even more savings!



**SAVE OVER
20%**

QTY	PART	DESCRIPTION	QTY	PART	DESCRIPTION	QTY	PART	DESCRIPTION
1	ATS-XX	ATS PRO RIVET GUN	1	ATS6104	REV. AIR DRILL (3/8" CHUCK)	1	ATSRS-3SD	HAND RIVET SQUEEZER
1	KMC-1022	HOMARK 22" TOOLBOX	1	DS-12	DRILL STOP (3/16)	1	4263DP-2	DIMPLE DIE SET (3/32)
1	140	BUCKING BAR	1	DS-21	DRILL STOP (5/32)	1	4264DP-2	DIMPLE DIE SET (1/8)
1	141	BUCKING BAR	1	DS-30	DRILL STOP (1/8)	1	4265DP-2	DIMPLE DIE SET (5/32")
1	142	BUCKING BAR	1	DS-40	DRILL STOP (3/32)	1	4266DP-2	DIMPLE DIE SET (3/16")
1	147	BUCKING BAR	1	A601	ANGLE DRILL ATTACHMENT	1	4703-2	SQUEEZER SET (3/32")
1	148	BUCKING BAR	1	1824	AIR REGULATOR	1	4704-2	SQUEEZER SET (1/8")
20	CL-3/32	CLECOS (SILVER)	1	130	RIVET CUTTER	1	4705-2	SQUEEZER SET (5/32")
20	CL-1/8	CLECOS (COPPER)	1	64823	HAND NIBBLER	1	4706-2	SQUEEZER SET (3/16")
20	CL-5/32	CLECOS (BLACK)	1	ATSRS-1SDY	1 1/2" YOKE	1	4710-2	SQUEEZER SET (FLUSH 1/2")
20	CL-3/16	CLECOS (GOLD)	1	61	STRAP DUPLICATOR (3/32)	1	3710-2	SQUEEZER SET (FLUSH 3/8")
1	131	CLECO PLIERS	1	62	STRAP DUPLICATOR (1/8)	1	06785	DIMPLE DIE ORGANIZER
1	470-3-3/32	RIVET SET (AN470, 3/32")	1	63	STRAP DUPLICATOR (5/32)	1	133	STOP COUNTERSINK
1	470-3-1/8	RIVET SET (AN470, 1/8")	1	65	STRAP DUPLICATOR (3/16)	1	1000-100-40	PILOTED CUTTER (3/32)
1	470-3-5/32	RIVET SET (AN470, 5/32")	1	FP10	FLUTING PLIERS	1	1000-100-30	PILOTED CUTTER (1/8)
1	470-3-3/16	RIVET SET (AN470, 3/16")	1	SP2005	CHIP CHASER 6"	1	1000-100-21	PILOTED CUTTER (5/32)
1	0470-3-3/32	OFFSET RIVET SET (3/32")	1	ATB8362	STANDARD AIRCRAFT BOOK	1	1000-100-12	PILOTED CUTTER (3/16)
1	0470-3-1/8	OFFSET RIVET SET (1/8")	1	5000-40	THREADED DRILL BIT (3/32)	1	4187	DIMPLE DIE BLOCK
1	0470-3-5/32	OFFSET RIVET SET (5/32")	1	5000-30	THREADED DRILL BIT (1/8)	1	12A	RUBBERGUARD FLUSH SET
1	0470-3-3/16	OFFSET RIVET SET (3/16")	1	5000-21	THREADED DRILL BIT (5/32)	1	750	FLUSH RIVET SET
1	M6R	OFFSET SNIP (LEFT CUT)	1	5000-12	THREADED DRILL BIT (3/16)			
1	M7R	OFFSET SNIP (RIGHT CUT)						

Our Deluxe Riveting Kit contains everything needed to build and maintain an all metal aircraft. This kit is highly recommended for the professional mechanic or the experienced home builder.

- 135-2602AKT(With 2602A Economy 3X Rivet Gun) \$969.95
- 135-2XKT (With ATS Pro 2X Rivet Gun) \$995.95
- 135-3XKT (With ATS Pro 3X Rivet Gun) \$999.95
- 135-4XKT (With ATS Pro 4X Rivet Gun) \$1,005.95





RIVETING KITS

MASTER BUILDER'S KIT

**SAVE OVER
15%
ON OUR
635 PIECE KIT**



QTY	PART	DESCRIPTION	QTY	PART	DESCRIPTION	QTY	PART	DESCRIPTION
1	ATS-XX	ATS PRO RIVET GUN	1	133	ADJUSTABLE MICROSTOP	1	SP2005	CHIP CHASER (6")
1	KMC-1022	HOMARK 22" TOOL BOX	1	1000-100-40	PILOT CUTTER (3/32)	1	SP2005S	CHIP CHASER (2.5")
1	1824	AIR REGULATOR	1	1000-100-30	PILOT CUTTER (1/8)	1	ATS6104	REVERSIBLE AIR DRILL
1	470-3-3/32	RIVET SET (AN470, 3/32")	1	1000-100-21	PILOT CUTTER (5/32)	2	012-40	COBALT DRILL BITS
1	470-3-1/8	RIVET SET (AN470, 1/8")	1	1000-100-12	PILOT CUTTER (3/16)	2	012-30	COBALT DRILL BITS
1	470-3-5/32	RIVET SET (AN470, 5/32")	1	4187	DIMPLE DIE BLOCK SET	2	012-21	COBALT DRILL BITS
1	470-3-3/16	RIVET SET (AN470, 3/16")	1	4263DP-2	DIMPLE DIE SET (3/32)	2	012-12	COBALT DRILL BITS
1	0470-3-3/32	OFFSET RIVET SET (3/32")	1	4264DP-2	DIMPLE DIE SET (1/8)	1	DS-40	DRILL STOP (3/32)
1	0470-3-1/8	OFFSET RIVET SET (1/8")	1	4265DP-2	DIMPLE DIE SET (5/32")	1	DS-30	DRILL STOP (1/8)
1	0470-3-5/32	OFFSET RIVET SET (5/32")	1	4266DP-2	DIMPLE DIE SET (3/16")	1	DS-21	DRILL STOP (5/32")
1	0470-3-3/16	OFFSET RIVET SET (3/16")	1	4703-2	SQUEEZER SET (3/32")	1	DS-12	DRILL STOP (3/16)
1	750	FLUSH RIVET SET	1	4704-2	SQUEEZER SET (1/8")	1	013-40	EXTENSION DRILL BIT (6")
1	12A	RUBBERGUARD SET (1")	1	4705-2	SQUEEZER SET (5/32")	1	013-30	EXTENSION DRILL BIT (6")
1	12C	RUBBERGUARD SET (1-1/2")	1	4706-2	SQUEEZER SET (3/16")	1	013-21	EXTENSION DRILL BIT (6")
1	140	BUCKING BAR	2	4710-2	SQUEEZER SET (FLUSH 1/2")	1	013-12	EXTENSION DRILL BIT (6")
1	141	BUCKING BAR	2	3710-2	SQUEEZER SET (FLUSH 3/8")	1	61	STRAP DUPLICATOR (3/32)
1	142	BUCKING BAR	1	06785	DIMPLE DIE ORGANIZER	1	62	STRAP DUPLICATOR (1/8)
1	147	BUCKING BAR	1	5022-3A	HAND RIVET SQUEEZER (3")	1	63	STRAP DUPLICATOR (5/32")
1	148	BUCKING BAR	1	RS1004A	LONGERON YOKE	1	65	STRAP DUPLICATOR (3/16)
1	149	BUCKING BAR	1	RS1005A	4" YOKE	1	001A	AUTOMATIC CENTER PUNCH
120	CL-3/32	CLECOS (3/32")	1	RS1006A	CLOSE QUARTERS YOKE	1	ATB8362	STANDARD AIRCRAFT BOOK
120	CL-1/8	CLECOS (1/8")	1	RS-BK	BENCH MOUNT	1	1341A	RIVET REMOVAL TOOL
120	CL-5/32	CLECOS (5/32")	1	HS144	HAND SEAMER	1	A601	ANGLE DRILL ATTACHMENT
120	CL-3/16	CLECOS (3/16")	1	FT100	HOLE FLANGING TOOL	2	5000-40	THREADED DRILL BIT (40)
4	26EL	SIDE GRIP FASTENER	1	302-32	SAFETY WIRE (.032)	2	5000-30	THREADED DRILL BIT (30)
4	542	SPRING TENSION CLAMPS	1	515A	BURNISHING TOOL	2	5000-21	THREADED DRILL BIT (21)
10	KWN-3/32	WINGNUT FASTENER (3/32")	1	FP10	FLUTING PLIERS	2	5000-12	THREADED DRILL BIT (12)
10	KWN-1/8	WINGNUT FASTENER (1/8")	1	5B	CIRCLE (FLY) CUTTER	1	M6R	OFFSET SNIP (LEFT CUT)
10	KWN-5/32	WINGNUT FASTENER (5/32")	1	HC1	ADJUSTABLE HOLE CUTTER	1	M7R	OFFSET SNIP (RIGHT CUT)
10	KWN-3/16	WINGNUT FASTENER (3/16")	1	SP375A	SPEED DEBURRING TOOL	1	144ST	BENDER BRAKE (18")
1	131	CLECO PLIERS	1	64823	HAND NIBBLER	1	6WR	6" REV. WIRE TWISTER
1	130HD	RIVET CUTTER	1	C5R	CRIMPER			

This comprehensive riveting kit contains the tooling needed to build some of the most popular aluminum airplanes, including the RV series, and the Midget Mustang. It's also very popular with mechanics needing an all-in-one riveting kit

MBK-2602A	(With 2602A Economy 3X Rivet Gun)	\$1,925.95
MBK-2X	(With ATS Pro 2X Rivet Gun)	\$1,932.95
MBK-3X	(With ATS Pro 3X Rivet Gun)	\$1,935.95
MBK-4X	(With ATS Pro 4X Rivet Gun)	\$1,939.95

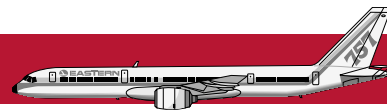

UNIVERSITY STUDENTS RIVETING KIT



QTY	PART	DESCRIPTION
1	ATS-XX	ATS 3X PRO RIVETING GUN
1	1824	AIR TOOL REGULATOR
1	470-3-1/8	1/8" STRAIGHT RIVET SET
1	470-3-3/16	3/16" STRAIGHT RIVET SET
1	470-3-3/32	3/32" STRAIGHT RIVET SET
1	470-3-5/32	5/32" STRAIGHT RIVET SET
1	750	FLUSH STRAIGHT RIVET SET
1	142	BUCKING BAR
1	130	RIVET CUTTER
12	CL-3/32	CLECOS (SILVER)
12	CL-1/8	CLECOS (COPPER)
8	CL-5/32	CLECOS (BLACK)
8	CL-3/16	CLECOS (GOLD)
1	131	CLECO PLIERS
1	ATS6104	REVERSIBLE AIR DRILL
2	012-40	COBALT DRILL BITS
2	012-30	COBALT DRILL BITS
1	012-21	COBALT DRILL BIT
1	012-12	COBALT DRILL BIT
1	DS-40	DRILL STOP
1	DS-30	DRILL STOP
1	DS-21	DRILL STOP
1	DS-12	DRILL STOP
1	19000	TOOL BOX

This kit is specifically designed for the Airframe student. It's equipped with all of the essential tools needed to work on sheet metal. This kit is currently being used by students in schools such as Vincennes University and others.

2602ASTUD	(With 2602A Economy 3X Gun)	\$285.95
2XSTUD	(With ATS Pro 2X Gun)	\$323.95
3XSTUD	(With ATS Pro 3X Gun)	\$329.95
4XSTUD	(With ATS Pro 4X Gun)	\$339.95

AIRCRAFT MECHANIC'S RIVETING KIT



QTY	PART	DESCRIPTION
1	ATS-XX	ATS 3X PRO RIVETING GUN
1	1824	AIR TOOL REGULATOR
1	140	BUCKING BAR
1	142	BUCKING BAR
1	147	BUCKING BAR
1	148	BUCKING BAR
1	470-3-1/8	1/8" STRAIGHT RIVET SET
1	470-3-3/16	3/16" STRAIGHT RIVET SET
1	470-3-3/32	3/32" STRAIGHT RIVET SET
1	470-3-5/32	5/32" STRAIGHT RIVET SET
1	750	FLUSH STRAIGHT RIVET SET
1	0470-3-1/8	1/8" OFFSET RIVET SET
1	0470-3-3/16	3/16" OFFSET RIVET SET
1	0470-3-3/32	3/32" OFFSET RIVET SET
1	0470-3-5/32	5/32" OFFSET RIVET SET
5	CL-3/32	CLECOS (SILVER)
5	CL-1/8	CLECOS (COPPER)
5	CL-5/32	CLECOS (BLACK)
5	CL-3/16	CLECOS (GOLD)
1	131	CLECO PLIERS
1	19000	TOOL BOX

A perfect starter kit for the A&P mechanic, the KT series of kits contains just the essentials needed for riveting. This kit is most commonly used as a starting point for mechanics wishing to make their own customized kits.

2602AKT	(With 2602A Economy 3X Gun)	\$269.95
2XKT	(With ATS Pro 2X Gun)	\$299.95
3XKT	(With ATS Pro 3X Gun)	\$309.95
4XKT	(With ATS Pro 4X Gun)	\$315.95

Didn't find the kit you were looking for?...Why not build your own!

Send us your list via e-mail to quotes@aircraft-tool.com to receive an immediate quotation. And be sure to include your delivery address and preferred method of shipment if you would like us to also quote shipping charges.



RIVETING KITS

RV-12 QUICK BUILD KIT



The new RV-12 is so easy to assemble it requires virtually no sheet metal skills, and needs little more than a few hand tools. We've made your task even easier by bringing together all the tools you'll need into one kit, and priced it to be easy on your wallet.

RV12-KIT \$1,598.95

RV BUILDER'S EMPENNAGE KIT



RVS-X Kit



Upgrade your Empennage Kit to the full RVK Kit with our RVS-UPG Upgrade Package.

This scaled down version of our RV Builder's Kit contains just the tools you need to get your feet wet with sheet metal construction. The kit closely follows the recommended tools list from Van's RV TRAINING PROJECT-1 and their TOOL BOX KIT projects. This kit is also the minimum recommended set of tools to build the empennage (tail) section of the RV3, RV4, RV7, RV8, RV9, and RV10 series of home built airplanes. Start out with this kit, and when you're ready to do more advanced work, get the upgrade package to take you all the way up to the full RV Builder's Tool Kit.

RVS-2602A.....(With 2602A 3X Rivet Gun) \$916.95
RVS-2X..... (With ATS Pro 2X Rivet Gun)..... \$922.95
RVS-3X..... (With ATS Pro 3X Rivet Gun)..... \$925.95
RVS-UPG(Upgrade Package) \$976.95

RIVETING KITS



RV BUILDER'S KIT



Redone to conform to Van's newest listing

QTY	PART	DESCRIPTION	QTY	PART	DESCRIPTION	QTY	PART	DESCRIPTION
1	ATS-XX	ATS RIVET GUN	1	O14-40	12" DRILL BIT (40)	1	FP21	FLUTING PLIERS
1	113M	E-Z RETAINER SPRING	1	O14-30	12" DRILL BIT (30)	1	130HD	RIVET CUTTER
1	7922R	SWIVEL AIR REGULATOR	1	SP375A	SPEED DEBURRING TOOL	1	ATSOIL	ATS AIR TOOL OIL
1	181	SWIVEL FLUSH SET (1")	1	131	CLECO PLIERS	1	21455	FILE CARD
1	470-3-3/32	RIVET SET (AN470, 3/32")	1	24EL	CLECO CLAMPS (1/2")	1	20547N	DUAL VIXEN FILE (10")
1	470-3-1/8	RIVET SET (AN470, 1/8")	4	26EL	CLECO CLAMPS (1")	1	204RV	C-FRAME RIVETING TOOL
1	470-3-3/16	RIVET SET (AN470, 3/16")	1	36021	SWIVEL POP RIVETER	1	DS-40	DRILL STOP (3/32)
1	1470-5-3/32	RIVET SET (DBL OFS 3/32")	2	OOP2	SCREWDRIVER BITS (2)	1	DS-30	DRILL STOP (1/8)
1	1470-5-1/8	RIVET SET (DBL OFS 1/8")	1	5022-3A	RIVET SQUEEZER (3")	1	DS-21	DRILL STOP (5/32)
1	1470-5-3/16	RIVET SET (DBL OFS 3/16")	1	RS-BK	SQUEEZER BENCH MOUNT	1	DS-12	DRILL STOP (3/16)
1	148	BUCKING BAR	1	4704-2	SQUEEZER SET (1/8")	1	A601	ANGLE DRILL ATTACHMENT
1	149	BUCKING BAR	1	4706-2	SQUEEZER SET (3/16")	1	PT-1136A	CORDLESS SCREWDRIVER
1	142	BUCKING BAR	2	4710-2	SQUEEZER SET (FLUSH 1/2")	1	5000-40	THREADED DRILL BIT (40)
1	133	MICROSTOP COUNTERSINK	2	3710-2	SQUEEZER SET (FLUSH 3/8")	1	5000-30	THREADED DRILL BIT (30)
1	1000-100-40	PILOT CUTTER (3/32")	1	4263DP-2	DIMPLE DIE SET (3/32)	1	5000-21	THREADED DRILL BIT (21)
1	1000-100-30	PILOT CUTTER (1/8")	1	4264DP-2	DIMPLE DIE SET (1/8)	1	5000-12	THREADED DRILL BIT (12)
1	1000-100-28	PILOT CUTTER (6 SCREW)	1	4508DP-2	DIMPLE DIE SET (8 SCREW)	1	2470	BACK RIVET SET
1	1000-100-19	PILOT CUTTER (8 SCREW)	1	52-340-024	STAINLESS STEEL RULE 24"	1	AE1065	BACK RIVET PLATE
1	1000-100-12	PILOT CUTTER (10 SCREW)	1	UNIBIT-3	UNIBIT (1/4" - 3/4" BY 1/16")	1	O6785	DIMPLE DIE ORGANIZER
1	M6R	WISS SNIP (LEFT & OFFSET)	1	MARKERS	PERMANENT MARKERS	1	685-1	3M RIVETER'S TAPE
1	M7R	WISS SNIP (RIGHT & OFFSET)	1	CP7AM	3M CUT & POLISH WHEEL 6"	1	CH1	DEAD BLOW HAMMER
1	ATS6104	REVERSIBLE AIR DRILL	1	QM24	HEARING PROTECTOR	1	HS144	HAND SEAMER
6	012-40	COBALT DRILL BITS (40)	1	5X605	SAFETY GLASSES	1	ATB8362	STANDARD AIRCRAFT BOOK
6	012-30	COBALT DRILL BITS (30)	325	CL-3/32	CLECOS (3/32)	1	SP2005	6" CHIP CHASER
2	012-19	COBALT DRILL BITS (19)	175	CL-1/8	CLECOS (1/8)	1	SP2005S	2.5" CHIP CHASER
2	012-12	COBALT DRILL BITS (12)	1	SVB-KIT	DEBURRING SET	1	KMC-1022	HOMARK 22" TOOL BOX
2	012-21	COBALT DRILL BITS (21)	1	SP201A	EDGE SCRAPER			

Our RV Builder's Kit closely conforms to Van's recommended tool list for their very popular line of RV home-built airplanes. It contains all of the tools necessary to successfully assemble the RV3, RV4, RV7, RV8, RV9, and RV10 series of home built airplanes.

RVK-2602A..... (With 2602A Economy 3X Rivet Gun)..... **\$1,910.95**
RVK-2X..... (With ATS Pro 2X Rivet Gun)..... **\$1,898.95**
RVK-3X..... (With ATS Pro 3X Rivet Gun)..... **\$1,919.95**

RIVET GUNS

ATS PRO X-SERIES RIVET GUNS



Scan to view video

I've never used a bucking type rivet gun before and I had some leaky 1/4 inch aluminum rivets to replace in my boat. As soon as I got the gun and the correct 1/4 set I replaced a dozen 1/4 inch rivets and tested all. No leaks! Great tool. Well worth the money. Looks to be a quality tool no junk. ~ Jeffrey



IMPROVED TRIGGER VALVE



Includes beehive and mechaid springs plus a FREE bottle of ATS Tool Oil

We've re-engineered the throttle valve of our top of the line ATS Pro-X Rivet Guns to give you unmatched controllability when setting rivets of any type or size. With the improved variable power control at your fingertips, you'll be able to confidently perform the proper steps of riveting which are: aligning the rivet (tapping); enlarging it into the hole (swelling); and driving it to its finished size (bucking). This is no air hammer, it's a true rivet gun - and there is a difference. Take advantage of our hassle-free 30 Day Money Back Guarantee and try it for yourself. And if it doesn't meet your expectations, send it back and we'll refund your full purchase price with no questions asked. This is also backed by our complete unconditional Lifetime Warranty! **Note: Our ATS-3X is our most popular model.**

PART	BPM	CAP.	STROKE	PRICE
ATS-2X	2580	1/8"	2-1/4"	\$175.95
ATS-3X	2160	3/16"	2-7/8"	\$179.95
ATS-4X	1740	1/4"	3-1/16"	\$185.95

RIVET GUNS

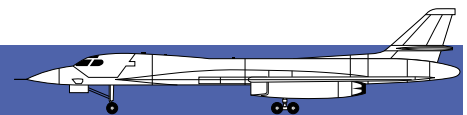

DESIGNER SERIES ATS PRO X-SERIES RIVET GUNS



Express your individuality with our Designer Pro Rivet Gun. You get the same rugged durability, reliability, and power of our Pro Series Rivet gun in an array of brilliant colors that will set you apart from the ordinary. Everything about this gun, from its rich vibrant color to the laser-etched ATS Pro logo on the side, reflects the outstanding quality you've come to expect from ATS.

PART	BPM	CAP.	STROKE	PRICE
ATS-2X-(color)	2580	1/8"	2-1/4"	\$199.95
ATS-3X-(color)	2160	3/16"	2-7/8"	\$205.95
ATS-4X-(color)	1740	1/4"	3-1/16"	\$209.95
COLOR	DESCRIPTION			
RED	CANDY APPLE RED			
BLUE	COBALT BLUE			
GREEN	METALLIC JADE			
BLACK	STARLIGHT BLACK			

Ordering Instructions: When ordering, please specify the size of the rivet gun, as well as the color desired.
Example: to order a RED 2X gun, use part number ATS-2X-RED.

ATS PRO RIVET GUN KITS



Our Best selling ATS pro riveting kit combines our excellent ATS Pro rivet gun with a selection of essential tools you'll need to successfully complete your next riveting job. The complete kit includes our ATS Pro series rivet gun with its newly redesigned throttle and its lifetime warranty; a selection of 4 bucking bars (141, 142, 148, 149), a set of 5 straight rivet sets, 4 offset rivet sets, 1 rubber guard flush rivet set, an air regulator, and a bottle of ATS tool oil. And it all comes packaged in a protected form fitted, blow molded case.

Note: If you already own an ATS Rivet Gun, you can upgrade to the full kit by purchasing the upgrade package which contains everything except the Rivet Gun.

ATS-2602PK.....	(Economy Gun Kit)	\$229.95
ATS-2XPK.....	(2X Gun Kit).....	\$295.95
ATS-3XPK.....	(3X Gun Kit).....	\$299.95
ATS-4XPK.....	(4X Gun Kit).....	\$305.95
ATS-PKU.....	(Upgrade Kit - No Gun).....	\$175.95



RIVET GUNS

ATS PRO JIFFY-STYLE RIVETING KIT



This Jiffy-Style Professional Riveting Kit is compact enough to get into impossibly tight riveting areas, while still delivering the full power of a 3X riveting gun. It features our ATS-200B Jiffy-Style Riveting Gun with a two stage trigger to properly "set" the rivet prior to bucking it. It also includes a full complement of rivet sets (snaps) to cover 3/32", 1/8", 5/32", and 3/32" Universal Head (AN470), Modified Brazier (AN456), and Flush Head (AN426) rivets. We've added two of our most popular Bucking Bars to help you get started right away. Completing this great package is a durable military-style canvas bag with ample space for your kit.

- ATS-200BK.....(Without Bucking Bars).....\$245.95
- ATS-200BK2..... (With Bucking Bars)\$259.95
- ATS-200B.....(Gun Only)\$199.95

JIFFY GUN STUBBY RIVET SETS



These rivet sets are designed to work with our ATS Pro 200B Rivet gun. They will also work with any Jiffy 100 or 200 rivet guns.

STRAIGHT RIVET SETS					
PART	SIZE	PRICE	PART	SIZE	PRICE
J510-4703	3/32"	\$10.95	J510-4706	3/16"	\$9.95
J510-4704	1/8"	\$10.95	J502	Flush	\$10.95
J510-4705	5/32"	\$10.95			
J510-SET	5 Piece Set (4 AN470 Sets & 1 Flush Set)				\$49.95
10 DEGREE OFFSET RIVET SETS					
J520-4703	3/32"	\$11.95	J520-4705	5/32"	\$11.95
J520-4704	1/8"	\$11.95	J520-4706	3/16"	\$11.95
J520-SET	4 Piece Set (AN470 Offset Sets)				\$41.95

ATS PRO .498" LARGE BORE RIVET GUNS



Our .498 shank rivet guns are heavy hitting to handle those larger riveting jobs that are beyond the capacity of smaller .401" shank rivet guns. Excellent for driving rivets of 1/4" diameter or larger. Completely interchangeable with Chicago Pneumatic guns, and they have excellent finger tip control. Accepts .498" shank rivet sets and attachments, but we've also included at no extra cost a .401" shank adapter (p/n SR498401) that allows you to use .401" tooling.

PART	BPM	CAP.	STROKE	WGT	PRICE
ATS-5X	1560	1/4"	2-11/16"	4.84 lbs	\$315.95
ATS-7X	900	3/8"	5-13/16"	5.94 lbs	\$365.95

.498 RIVET SETS

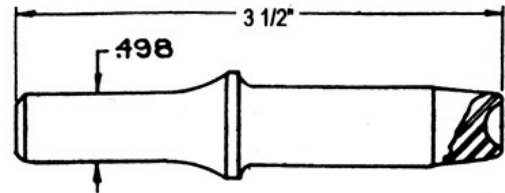

These rivet sets are designed to work with our ATS Pro 5X and 7X Rivet guns.

PART	DIAMETERS AVAILABLE	PRICE
STRAIGHT 3 1/2" UNIVERSAL HEAD (AN470)		
K470-3	3/32, 1/8, 5/32, 3/16, 1/4	\$13.95
OFFSET 3 1/2" UNIVERSAL HEAD (AN0470)		
K0470-3	3/32, 1/8, 5/32, 3/16, 1/4	\$15.95
3 1/2" MODIFIED BRAZIER (AN456)		
K456-3	3/32, 1/8, 5/32, 3/16, 1/4	\$14.95
3 1/2" BRAZIER HEAD (AN455)		
K455-3	3/32, 1/8, 5/32, 3/16, 1/4	\$13.95
3 1/2" FLAT HEAD (AN442)		
K442-3	3/32, 1/8, 5/32, 3/16, 1/4	\$13.95
3 1/2" BUTTON HEAD (AN435)		
K435-3	3/32, 1/8, 5/32, 3/16, 1/4	\$13.95
3 1/2" ROUND HEAD (AN430)		
K430-3	3/32, 1/8, 5/32, 3/16, 1/4	\$13.95

RIVET GUNS



ATS ECONOMY AIRCRAFT RIVET GUN



Includes beehive and mechaid springs plus a FREE bottle of ATS Tool Oil

The next generation of our best-selling 2602 Economy Rivet Gun is 6 ounces lighter, better balanced, and features a two-stage trigger. We've engineered the 2602A with your safety in mind by adding an ergonomic, vibration-reducing rubber grip that significantly reduces the hand-numbing effects of vibration shock. The 2602A has been recommended for use in many kits by their manufacturers such as the RV's, Thorp T-18, and the Midget Mustang. 0-2160 BPM, weight 3.2 lbs., 3CFM at 90 psi, .401 shank.

2602A(Rivet Gun Only)..... **\$129.95**
ATS-2602PK.....(Rivet Gun Kit) **\$229.95**

RETAINER SPRINGS

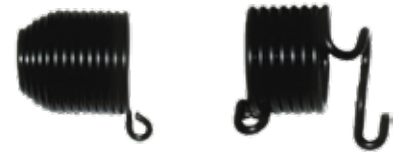

113B

113M

Fits all Rivet Guns and Air Hammers with a .401" shank.

113M.....(Mechaid Retainer)..... **\$4.95**
113B.....(Beehive Retainer)..... **\$4.95**
113B-1/4.... (Beehive for 1/4")..... **\$5.95**
13M.....(Spring Retainer Set) **\$7.95**

RIVET GUN AIR REGULATORS



7922R

1824

5401

Precision, quality built regulators, accurately control airflow at up to 150 psi. 1/4" NPT thread size.

7922R.... (360° Swivel Regulator) **\$12.95**
1824.... (Positive Lock Regulator).... **\$14.95**
5401..... (Low-Profile Regulator)..... **\$7.95**

ANTI-VIBRATION GLOVES



Anti-vibration gloves are designed to reduce vibration from pneumatic and vibrating tools or repetitive motions. The glove features strategically placed 5.0mm memory foam on the palm and thumb.

YGC78-S.....(Small)..... **\$27.95**
YGC78-M (Medium) **\$27.95**
YGC78-L..... (Large)..... **\$27.95**
YGC78-XL (Extra Large) **\$27.95**
YGC78-2XL..... (2X) **\$27.95**

TOOL OIL



ATSOIL

ATSOIL-QT

ATS brand Synthetic Air Tool Oil is ideal for all air powered tools. Will not gum up like most petroleum or fish oil lubricants. Mild solvent action cleans as it lubricates. Pleasant "orange" scent.

ATSOIL(4 oz)..... **\$4.95**
ATSOIL-QT(1 qt)..... **\$12.95**

RIVET GUN SHANK ADAPTER (.498 TO .401)



This adapter reduces the shank bore of .498 rivet guns (5X and higher) so that you can use standard .401" tooling with them. Hardened tool steel construction. Precisely ground. Remember to use a regulator when using .401 tools with a large bore gun.

SR498401 **\$14.95**

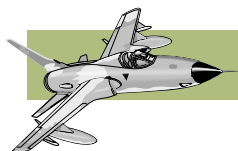

RIVETS

CHERRYMAX® FLUSH HEAD



CR3212 & CR3242

CHERRYMAX® UNIVERSAL HEAD



CR3213 & CR3243

SIZE	GRIP LENGTH	NOMINAL (CR3212)		OVERSIZE (CR3242)		NOMINAL (CR3213)		OVERSIZE (CR3243)	
		50 PCS	100 PCS	50 PCS	100 PCS	50 PCS	100 PCS	50 PCS	100 PCS
4-1	VARIABLES	N/A	N/A	\$33.95	\$62.95	\$33.95	\$62.95	\$29.95	\$54.95
4-2	.063-.125	\$25.95	\$46.95	\$26.95	\$49.95	\$26.95	\$49.95	\$35.95	\$65.95
4-3	.126-.187	\$25.95	\$46.95	\$28.95	\$52.95	\$26.95	\$49.95	\$25.95	\$46.95
4-4	.188-.250	\$26.95	\$49.95	\$28.95	\$52.95	\$28.95	\$52.95	\$28.95	\$52.95
4-5	.251-.312	\$29.95	\$54.95	\$32.95	\$59.95	\$33.95	\$62.95	\$30.95	\$57.95
4-6	.313-.375	\$28.95	\$52.95	\$36.95	\$67.95	\$36.95	\$67.95	\$36.95	\$67.95
4-7	.376-.437	\$34.95	\$63.95	\$36.95	\$67.95	\$43.95	\$80.95	\$37.95	\$70.95
4-8	.438-.500	\$52.95	\$97.95	\$39.95	\$72.95	\$52.95	\$97.95	\$45.95	\$84.95
5-1	.031-.062	POA	POA	POA	POA	POA	POA	POA	POA
5-2	.063-.125	\$30.95	\$55.95	\$28.95	\$52.95	\$28.95	\$52.95	\$32.95	\$59.95
5-3	.126-.187	\$28.95	\$52.95	\$30.95	\$55.95	\$28.95	\$52.95	\$32.95	\$59.95
5-4	.188-.250	\$29.95	\$54.95	\$29.95	\$54.95	\$28.95	\$52.95	\$30.95	\$55.95
5-5	.251-.312	\$31.95	\$58.95	\$31.95	\$58.95	\$31.95	\$58.95	\$35.95	\$65.95
5-6	.313-.375	\$40.95	\$75.95	\$31.95	\$58.95	\$35.95	\$65.95	\$36.95	\$67.95
5-7	.376-.437	\$54.95	\$101.95	\$43.95	\$80.95	\$42.95	\$78.95	\$39.95	\$72.95
5-8	.438-.500	\$45.95	\$84.95	\$39.95	\$72.95	\$44.95	\$81.95	\$40.95	\$75.95
6-1	.037-.062	POA	POA	POA	POA	POA	POA	POA	POA
6-2	.063-.125	\$33.95	\$62.95	\$31.95	\$58.95	\$39.95	\$72.95	\$29.95	\$54.95
6-3	.126-.187	\$35.95	\$65.95	\$28.95	\$52.95	\$33.95	\$62.95	\$30.95	\$57.95
6-4	.188-.250	\$32.95	\$59.95	\$53.95	\$100.95	\$33.95	\$62.95	\$29.95	\$54.95
6-5	.251-.312	\$33.95	\$62.95	\$45.95	\$84.95	\$39.95	\$72.95	\$30.95	\$57.95
6-6	.313-.375	\$41.95	\$76.95	\$37.95	\$70.95	\$33.95	\$62.95	\$33.95	\$62.95
6-7	.376-.437	\$39.95	\$72.95	\$40.95	\$75.95	\$47.95	\$88.95	\$39.95	\$72.95
6-8	.438-.500	\$40.95	\$75.95	\$84.95	\$156.95	\$44.95	\$83.95	\$39.95	\$72.95

CHERRYMAX RIVET ASSORTMENT



An assortment of 125 rivets consisting of 25 each of the 5 most popular sizes: CR3243-4-1, CR3243-4-2, CR3243-4-3, CR3242-4-2, and CR3242-4-3.

CM25\$79.95

SWIVEL BLIND RIVETER



PULLS CHERRY MAX

This riveter has a swivel head which rotates a full 360° for versatility, doubling as a 90° off-set riveter, or a straight (in line) puller just by rotating the head. Pulls up to 3/16" CherryMax® and other blind rivets without additional attachments.

36021.....\$37.95

RIVETS



SOLID ALUMINUM RIVETS



MS20426 Series



MS20470 Series

Medium-hard (AD) solid Aluminum rivets have a gold anodized finish to resist corrosion. When ordering, note that the first dash gives the diameter in 1/32" increments, and the second dash gives the length in 1/16" increments. Example: MS20470AD-4-5 is an 1/8" Dia x 5/16" Length.

PART NUMBER	1/4LB	PART NUMBER	1LB CERT	PART NUMBER	1/4LB	PART NUMBER	1LB CERT
MS20426AD-3-3	\$12.95	MS20426AD-3-3C	\$46.95	MS20470AD-3-3	\$11.95	MS20470AD-3-3C	\$42.95
MS20426AD-3-4	\$14.95	MS20426AD-3-4C	\$53.95	MS20470AD-3-4	\$9.95	MS20470AD-3-4C	\$36.95
MS20426AD-3-5	\$9.95	MS20426AD-3-5C	\$36.95	MS20470AD-3-5	\$9.95	MS20470AD-3-5C	\$34.95
MS20426AD-3-6	\$9.95	MS20426AD-3-6C	\$34.95	MS20470AD-3-6	\$8.95	MS20470AD-3-6C	\$32.95
MS20426AD-3-7	\$8.95	MS20426AD-3-7C	\$32.95	MS20470AD-3-7	\$8.95	MS20470AD-3-7C	\$32.95
MS20426AD-3-8	\$9.95	MS20426AD-3-8C	\$36.95	MS20470AD-3-8	\$7.95	MS20470AD-3-8C	\$29.95
MS20426AD-4-3	\$8.95	MS20426AD-4-3C	\$32.95	MS20470AD-4-3	\$7.95	MS20470AD-4-3C	\$27.95
MS20426AD-4-4	\$6.95	MS20426AD-4-4C	\$25.95	MS20470AD-4-4	\$6.95	MS20470AD-4-4C	\$24.95
MS20426AD-4-5	\$6.95	MS20426AD-4-5C	\$25.95	MS20470AD-4-5	\$5.95	MS20470AD-4-5C	\$21.95
MS20426AD-4-6	\$6.95	MS20426AD-4-6C	\$24.95	MS20470AD-4-6	\$6.95	MS20470AD-4-6C	\$22.95
MS20426AD-4-7	\$6.95	MS20426AD-4-7C	\$22.95	MS20470AD-4-7	\$5.95	MS20470AD-4-7C	\$21.95
MS20426AD-4-8	\$6.95	MS20426AD-4-8C	\$23.95	MS20470AD-4-8	\$6.95	MS20470AD-4-8C	\$22.95
MS20426AD-5-3	\$6.95	MS20426AD-5-3C	\$22.95	MS20470AD-5-3	\$6.95	MS20470AD-5-3C	\$25.95
MS20426AD-5-4	\$5.95	MS20426AD-5-4C	\$21.95	MS20470AD-5-4	\$6.95	MS20470AD-5-4C	\$23.95
MS20426AD-5-5	\$5.95	MS20426AD-5-5C	\$21.95	MS20470AD-5-5	\$5.95	MS20470AD-5-5C	\$20.95
MS20426AD-5-6	\$6.95	MS20426AD-5-6C	\$22.95	MS20470AD-5-6	\$5.95	MS20470AD-5-6C	\$21.95
MS20426AD-5-7	\$5.95	MS20426AD-5-7C	\$20.95	MS20470AD-5-7	\$5.95	MS20470AD-5-7C	\$21.95
MS20426AD-5-8	\$5.95	MS20426AD-5-8C	\$21.95	MS20470AD-5-8	\$5.95	MS20470AD-5-8C	\$21.95
MS20426AD-6-3	\$6.95	MS20426AD-6-3C	\$25.95	MS20470AD-6-3	\$5.95	MS20470AD-6-3C	\$20.95
MS20426AD-6-4	\$6.95	MS20426AD-6-4C	\$23.95	MS20470AD-6-4	\$5.95	MS20470AD-6-4C	\$20.95
MS20426AD-6-5	\$4.95	MS20426AD-6-5C	\$18.95	MS20470AD-6-5	\$5.95	MS20470AD-6-5C	\$20.95
MS20426AD-6-6	\$5.95	MS20426AD-6-6C	\$19.95	MS20470AD-6-6	\$5.95	MS20470AD-6-6C	\$19.95
MS20426AD-6-7	\$5.95	MS20426AD-6-7C	\$21.95	MS20470AD-6-7	\$5.95	MS20470AD-6-7C	\$19.95
MS20426AD-6-8	\$5.95	MS20426AD-6-8C	\$21.95	MS20470AD-6-8	\$5.95	MS20470AD-6-8C	\$20.95

SHOP HEAD RIVET GAUGE



AE1007



AE1008

Set of four shop head gauges plus one rivet length gauge for -3, -4, -5, and -6 rivets. Measures rivet length as well as minimum height and minimum diameter of shop heads after setting. Works for both universal head and flush rivets.

AE1007-KIT(Avery Brand, USA)..... \$32.95

RG031-KIT(Economy)..... \$13.95

HOW TO DETERMINE RIVET LENGTH

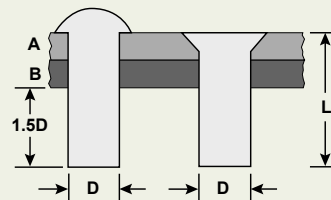

Measure the grip thickness of the section to be riveted (A+B), and add to that 1.5 times the rivet diameter (D). Round result to nearest 1/16" to get length.

Example: A = .030, B = .250, Rivet Diameter (D) = .125 (1/8")
 Grip Thickness = A+B = .280; Length (L) = .280 + 1.5*(.125) = .4675; Multiply by 16 to find the nearest 1/16: Length*16 = 7.48
 Therefore, the correct length is either a -7 or a -8 (e.g. MS20470-4-7 or MS20426-4-8).



RIVETS

NAS1097AD "OOPS" FLUSH RIVETS



NAS1097AD Flush Shear Rivets are more commonly referred to in maintenance circles as "oops" rivets because it's just what you need when you accidentally make your rivet hole too big. Their smaller head diameters are exactly the same as an AN426 flush rivet that is one size smaller. So just drill to the next larger size, then use one of these rivets and no one will be any the wiser.

PART NUMBER	SIZE	PRICE
NAS1097AD-3-3.5	3/32" x 7/32"	\$5.95
NAS1097AD-3-3	3/32" x 3/16"	\$6.95
NAS1097AD-3-4	3/32" x 1/4"	\$4.95
NAS1097AD-3-5	3/32" x 5/16"	\$5.95
NAS1097AD-3-6	3/32" x 3/8"	\$5.95
NAS1097AD-4-3.5	1/8" x 7/32"	\$4.95
NAS1097AD-4-4	1/8" x 1/4"	\$4.95
NAS1097AD-4-5	1/8" x 5/16"	\$4.95
NAS1097AD-4-6	1/8" x 3/8"	\$4.95
NAS1097AD-5-4	5/32" x 1/4"	\$3.95
NAS1097AD-5-5	5/32" x 5/16"	\$3.95
NAS1097AD-5-6	5/32" x 3/8"	\$3.95
NAS1097AD-6-5	3/16" x 5/16"	\$3.95
NAS1097AD-6-6	3/16" x 3/8"	\$3.95
NAS1097AD-KIT	Complete Kit	\$21.95

LANCASTER RIVET CUTTER



This heavy-duty rivet cutter manufactured by Lancaster Pumps is designed to mount onto a workbench (or held in vise), and will cut five (5) different diameter rivets, wire, and screws to any of seven (7) different lengths.

RC-1.....\$142.95

SOLID RIVET ASSORTMENT PACK



An assortment of rivets in various diameters and lengths to cover most light riveting needs. MS20470 (universal) and MS20426 (flush) series rivets in the following sizes: 3-3, 3-4, 3-5, 4-4, 4-5, 4-6, 5-4, 5-5, 5-6, 6-5, 6-6, 6-7.

MS20470AD-PK.....(MS20470AD Rivets).....\$34.95

MS20426AD-PK.....(MS20426AD Rivets).....\$34.95

CHERRYMAX GRIP GAUGE



Used to determine the proper grip length of Cherrymax® rivets. Easy to use: just insert the gauge into the prepared hole, draw the gauge back until the hook contacts the backside of the structure, then take your reading directly from the gauge.

269C3.....\$13.95

CHERRYMAX RIVET TRIMMER



Ground flush for close trimming of Cherrymax rivets.

HT2.....\$21.95

For more information about our products, visit our website www.aircraft-tool.com.

RIVETS

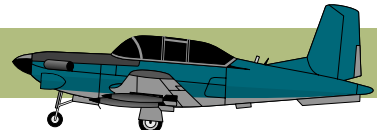

ATS RIVET CUTTERS

130



130HD

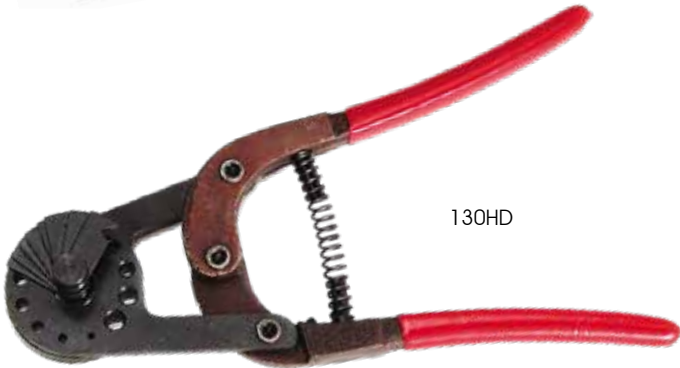

Cuts from 3/32" to 1/4" diameter. Cuts same length every time with use of Rivet leaf spacers.

- 130.....(Standard).....\$21.95
- 130HD.....(Heavy Duty).....\$40.95

ATS DELUXE RIVET REMOVAL TOOL

Unique serrated nose is designed to efficiently remove both blind and solid rivets



Scan to view video



Our Blind Rivet Removal Tool is designed to remove those stubborn Pop, Avdel, Cherry-Qt, and other blind rivets. The serrated end cups over any button head, round head, or universal head rivet and locks in place to keep it from spinning as it's being drilled out. It will also remove solid button-head style rivets. Includes adapters to remove 3/32", 1/8", 5/32", and 3/16" rivets. Not for use with steel-stemmed blind rivets.

- 1341S.....(Deluxe Rivet Removal Tool).....\$75.95

CLOSE QUARTER RIVET REMOVAL TOOL



This close quarter's rivet removal kit allows you to drill straight and dead center every time when removing 3/32", 1/8", 5/32", 3/16", and 1/4" diameter universal head (AN470) solid rivets. Fits any air or electric drill. The guides are compact and will work perfectly in tight places with an angle drill. Made in the U.S.A.

- LRDG-KIT.....\$136.95

ATS SOLID RIVET REMOVAL TOOL



WITH

WITHOUT





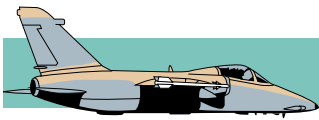



Cleanly removes any style button head rivet (Universal, Round, Brazier, Modified Brazier, etc.) without damaging the skin. Precision depth control allows you to drill off the head and punch out the body of the rivet for a clean extraction. Includes adapters to remove 3/32", 1/8", 5/32", and 3/16" rivets. Not for use with blind rivets.

- 1341A.....(Solid Rivet Removal Tool).....\$59.95



BUCKING BARS

TUNGSTEN BUCKING BARS

<p style="text-align: center;">ATS6001</p>  <p>5/8"x1"x4" 1.6 lbs ATS6001 \$125.95</p>	<p style="text-align: center;">ATS6004</p>  <p>5/8"x1.5"x2" 1.2 lbs ATS6004 \$119.95</p>	<p style="text-align: center;">ATS6005</p>  <p>3/4"x1.5"x2.5" 1.6 lbs ATS6005 \$169.95</p>
<p style="text-align: center;">ATS6006</p>  <p>3/4"x1.5"x2" 2 lbs ATS6006 \$125.95</p>	<p style="text-align: center;">ATS6007</p>  <p>4"x1"x5/8" 1.3 lbs ATS6007 \$139.95</p>	<p style="text-align: center;">ATS6008</p>  <p>1"x1"x2 1/2" 1.4 lbs ATS6008 \$125.95</p>
<p style="text-align: center;">ATS6009</p>  <p>2 1/4"x1 1/2"x7/8" 1.2 lbs ATS6009 \$165.95</p>	<p style="text-align: center;">TUNGSTEN BUCKING BAR SETS</p>  <p>2 piece set contains ATS6005, ATS6006. TBB-2 \$265.95 3 piece set contains ATS6005, ATS6006, ATS6007. TBB-3 \$369.95 4 piece set contains ATS6005, ATS6006, ATS6007, ATS6008 TBB-4 \$449.95</p>	

BUCKING BARS



STEEL BUCKING BARS

<p style="text-align: center;">140</p>  <p>5-1/8"x3"x1-5/8" 2 lbs 140 \$19.95</p>	<p style="text-align: center;">141</p>  <p>10-3/8"x1"x2" 3 lbs 141 \$19.95</p>	<p style="text-align: center;">142</p>  <p>6-3/8"x1"x2-1/4" 2 lbs 142 \$19.95</p>
<p style="text-align: center;">147</p>  <p>5-1/4"x2"x1" 1.5 lbs 147 \$19.95</p>	<p style="text-align: center;">148</p>  <p>3-3/4"x2"x1" 1.5 lbs 148 \$19.95</p>	<p style="text-align: center;">149</p>  <p>5-1/2"x1-1/2"x2" 3 lbs 149 \$19.95</p>
<p style="text-align: center;">150</p>  <p>6"x1"x1-3/4" 1.5 lbs 150 \$19.95</p>	<p style="text-align: center;">153</p>  <p>2-1/2"x2"x1-1/2" 1 lb 153 \$19.95</p>	<p style="text-align: center;">154</p>  <p>6"x1-1/2"x1-1/2" 1.75 lbs 154 \$19.95</p>
<p style="text-align: center;">161</p>  <p>4"x1"x2" 1.75 lbs 161 \$19.95</p>	<p style="text-align: center;">AT750-23</p>  <p>8"x3"x1-1/2" 1.5 lbs AT750-23 \$19.95</p>	<p style="text-align: center;">SAVE ON BUCKING BAR SETS!</p> <p>Our 4 piece set comes with the following: 141, 142, 148, and 149 4PC \$67.95</p> <p>The 6 piece package has the following bucking bars: 140, 141, 142, 147, 148, and 149 6PC \$95.95</p> <p>The 11 piece package consists of each of the following: 140, 141, 142, 147, 148, 149, 150, 153, 154 161 and AT750-23. 11PC \$165.95</p>



RIVETING EQUIPMENT

STANDARD .401" RIVET SETS

STRAIGHT .401" SHANK RIVET SETS

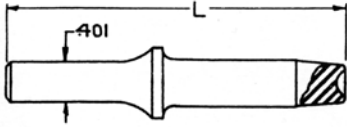

Note: To order, please specify the part number and the diameter.
 Example: to order a 3-1/2" long 1/8" diameter Universal Head set, the number would be 470-3-1/8.

PART	LEN (L)	DIAMETERS AVAILABLE	PRICE
UNIVERSAL HEAD (AN470)			
470-2	2-1/2"	3/32, 1/8, 5/32, 3/16, 1/4	\$7.95
470-3	3-1/2"	3/32, 1/8, 5/32, 3/16, 7/32, 1/4"	\$6.95
470-5	5-1/2"	3/32, 1/8, 5/32, 3/16, 1/4	\$7.95
470-7	7-1/2"	3/32, 1/8, 5/32, 3/16, 1/4	\$8.95
470-10	10-1/2"	3/32, 1/8, 5/32, 3/16, 1/4	\$12.95
MODIFIED BRAZIER (AN456)			
456-2	2-1/2"	3/32, 1/8, 5/32, 3/16, 1/4	\$11.95
456-3	3-1/2"	3/32, 1/8, 5/32, 3/16, 1/4	\$11.95
456-5	5-1/2"	3/32, 1/8, 5/32, 3/16, 1/4	\$13.95
456-7	7-1/2"	3/32, 1/8, 5/32, 3/16, 1/4	\$14.95
456-10	10-1/2"	3/32, 1/8, 5/32, 3/16, 1/4	\$19.95
BRAZIER HEAD (AN455)			
455-2	2-1/2"	3/32, 1/8, 5/32, 3/16, 1/4	\$8.95
455-3	3-1/2"	3/32, 1/8, 5/32, 3/16, 1/4	\$12.95
455-5	5-1/2"	3/32, 1/8, 5/32, 3/16, 1/4	\$13.95
455-7	7-1/2"	3/32, 1/8, 5/32, 3/16, 1/4	\$13.95
455-10	10-1/2"	3/32, 1/8, 5/32, 3/16, 1/4	\$16.95
FLAT HEAD (AN442)			
442-2	2-1/2"	3/32, 1/8, 5/32, 3/16, 1/4	\$9.95
442-3	3-1/2"	3/32, 1/8, 5/32, 3/16, 1/4	\$9.95
442-5	5-1/2"	3/32, 1/8, 5/32, 3/16, 1/4	\$11.95
442-7	7-1/2"	3/32, 1/8, 5/32, 3/16, 1/4	\$10.95
442-10	10-1/2"	3/32, 1/8, 5/32, 3/16, 1/4	\$16.95
BUTTON HEAD (AN435)			
435-2	2-1/2"	3/32, 1/8, 5/32, 3/16, 1/4	\$9.95
435-3	3-1/2"	3/32, 1/8, 5/32, 3/16, 1/4	\$9.95
435-5	5-1/2"	3/32, 1/8, 5/32, 3/16, 1/4	\$11.95
435-7	7-1/2"	3/32, 1/8, 5/32, 3/16, 1/4	\$13.95
435-10	10-1/2"	3/32, 1/8, 5/32, 3/16, 1/4	\$16.95
ROUND HEAD (AN430)			
430-2	2-1/2"	3/32, 1/8, 5/32, 3/16, 1/4	\$9.95
430-3	3-1/2"	3/32, 1/8, 5/32, 3/16, 1/4	\$9.95
430-5	5-1/2"	3/32, 1/8, 5/32, 3/16, 1/4	\$11.95
430-7	7-1/2"	3/32, 1/8, 5/32, 3/16, 1/4	\$12.95
430-10	10-1/2"	3/32, 1/8, 5/32, 3/16, 1/4	\$16.95

10° OFFSET .401" SHANK RIVET SETS

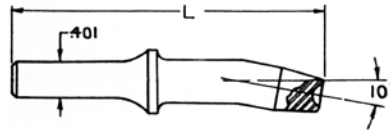

PART	LEN (L)	DIAMETERS AVAILABLE	PRICE
UNIVERSAL HEAD (AN470)			
0470-3	3-1/2"	3/32, 1/8, 5/32, 3/16, 1/4"	\$8.95
0470-5	5-1/2"	3/32, 1/8, 5/32, 3/16, 1/4	\$9.95
0470-7	7-1/2"	3/32, 1/8, 5/32, 3/16, 1/4	\$10.95
0470-10	10-1/2"	3/32, 1/8, 5/32, 3/16, 1/4	\$14.95
MODIFIED BRAZIER (AN456)			
0456-3	3-1/2"	3/32, 1/8, 5/32, 3/16, 1/4	\$12.95
0456-5	5-1/2"	3/32, 1/8, 5/32, 3/16, 1/4	\$13.95
0456-7	7-1/2"	3/32, 1/8, 5/32, 3/16, 1/4	\$15.95
0456-10	10-1/2"	3/32, 1/8, 5/32, 3/16, 1/4	\$20.95
BRAZIER HEAD (AN455)			
0455-3	3-1/2"	3/32, 1/8, 5/32, 3/16, 1/4	\$12.95
0455-5	5-1/2"	3/32, 1/8, 5/32, 3/16, 1/4	\$13.95
0455-7	7-1/2"	3/32, 1/8, 5/32, 3/16, 1/4	\$15.95
0455-10	10-1/2"	3/32, 1/8, 5/32, 3/16, 1/4	\$20.95
FLAT HEAD (AN442)			
0442-3	3-1/2"	3/32, 1/8, 5/32, 3/16, 1/4	\$12.95
0442-5	5-1/2"	3/32, 1/8, 5/32, 3/16, 1/4	\$13.95
0442-7	7-1/2"	3/32, 1/8, 5/32, 3/16, 1/4	\$15.95
0442-10	10-1/2"	3/32, 1/8, 5/32, 3/16, 1/4	\$20.95
BUTTON HEAD (AN435)			
0435-3	3-1/2"	3/32, 1/8, 5/32, 3/16, 1/4	\$12.95
0435-5	5-1/2"	3/32, 1/8, 5/32, 3/16, 1/4	\$13.95
0435-7	7-1/2"	3/32, 1/8, 5/32, 3/16, 1/4	\$15.95
0435-10	10-1/2"	3/32, 1/8, 5/32, 3/16, 1/4	\$20.95
ROUND HEAD (AN430)			
0430-3	3-1/2"	3/32, 1/8, 5/32, 3/16, 1/4	\$12.95
0430-5	5-1/2"	3/32, 1/8, 5/32, 3/16, 1/4	\$11.95
0430-7	7-1/2"	3/32, 1/8, 5/32, 3/16, 1/4	\$15.95
0430-10	10-1/2"	3/32, 1/8, 5/32, 3/16, 1/4	\$20.95

FLUSH .401" SHANK RIVET SETS

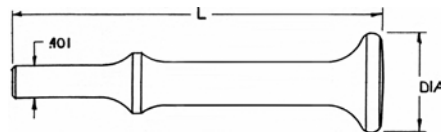

PART	LENGTH	DIAMETER	PRICE
90	3-1/2"	1" Dia	\$12.95
94	3-1/2"	1-1/4" Dia	\$14.95
95	5-1/2"	1-1/4" Dia	\$24.95
094	3-1/2"	1-1/4" Dia 10° offset	\$19.95
095	5-1/2"	1-1/4" Dia 10° offset	\$26.95

RIVETING EQUIPMENT



DOUBLE OFFSET .401" SHANK RIVET SETS

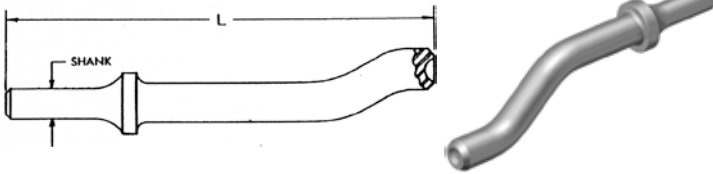

Note: To order, please specify the part number and the diameter. Example: to order a 7-1/2" long 1/4" diameter Flat Head set, the number would be 1442-7-1/4.

PART	LEN (L)	DIAMETERS AVAILABLE	PRICE
UNIVERSAL HEAD (AN470)			
1470-5	5-1/2"	3/32, 1/8, 5/32, 3/16, 1/4	\$10.95
1470-7	7-1/2"	3/32, 1/8, 5/32, 3/16, 1/4	\$11.95
1470-10	10-1/2"	3/32, 1/8, 5/32, 3/16, 1/4	\$12.95
MODIFIED BRAZIER (AN456)			
1456-5	5-1/2"	3/32, 1/8, 5/32, 3/16, 1/4	\$20.95
1456-7	7-1/2"	3/32, 1/8, 5/32, 3/16, 1/4	\$21.95
BRAZIER HEAD (AN455)			
1455-5	5-1/2"	3/32, 1/8, 5/32, 3/16	\$20.95
1455-7	7-1/2"	3/32, 1/8, 5/32, 3/16	\$21.95
FLAT HEAD (AN442)			
1442-5	5-1/2"	3/32, 1/8, 5/32, 3/16, 1/4	\$14.95
1442-7	7-1/2"	3/32, 1/8, 5/32, 3/16, 1/4	\$21.95
BUTTON HEAD (AN435)			
1435-5	5-1/2"	3/32, 1/8, 5/32, 3/16, 1/4	\$20.95
1435-7	7-1/2"	3/32, 1/8, 5/32, 3/16, 1/4	\$21.95
ROUND HEAD (AN430)			
1430-5	5-1/2"	3/32, 1/8, 5/32, 3/16, 1/4	\$20.95
1430-7	7-1/2"	3/32, 1/8, 5/32, 3/16, 1/4	\$21.95

7 1/2" GOOSENECK .401" SHANK RIVET SETS

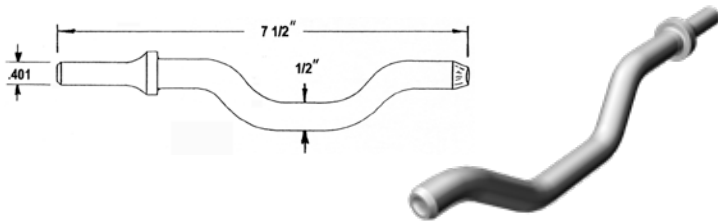

PART	CUPPING	DIAMETERS	PRICE
5470	AN470	3/32, 1/8, 5/32, 3/16	\$29.95
5456	AN456	3/32, 1/8, 5/32, 3/16	\$59.95
5455	AN455	3/32, 1/8, 5/32, 3/16	\$59.95
5442	AN442	3/32, 1/8, 5/32, 3/16	\$59.95
5435	AN435	3/32, 1/8, 5/32, 3/16	\$59.95
5430	AN430	3/32, 1/8, 5/32, 3/16	\$59.95

STANDARD RIVET SET MIX



The 5 piece mix contains the following sizes Universal Head (AN470) rivet sets: 3/32", 1/8", 5/32", 3/16" and 1 flush set. Each rivet set is 3-1/2" long.

120.....(Standard).....\$29.95
 120A(Heavy Duty).....\$31.95

10 DEGREE OFFSET RIVET SET MIX



The offset mix contains the following sizes Universal Head (AN470) rivet sets: 3/32", 1/8", 5/32", and 3/16". Each rivet set is 3-1/2" long.

121.....\$29.95

EXTRA LONG RIVET SET MIX



The extra long mix contains the following 4 sizes Universal Head (AN470) rivet sets: 3/32", 1/8", 5/32", and 3/16". Each long rivet set is 5-1/2" long.

125.....\$29.95

AN450 SEMI-TUBULAR RIVET SETS



PART	LENGTH	DIAMETER	PRICE
SM10-4503	3 1/2"	3/32"	\$25.95
SM10-4504	3 1/2"	1/8"	\$25.95
SM10-4505	3 1/2"	5/32"	\$25.95
SM10-4506	3 1/2"	3/16"	\$25.95
SM10-4508	3 1/2"	1/4"	\$24.95



RIVETING EQUIPMENT

BACK RIVET SET



2470



AE4595

Superior for back riveting flush rivets without damage to the skin surface. Spring loaded plastic guard holds down skin while riveting. Can also be used for "straight" riveting. .401 shank.

- 2470..... (ATS Brand)\$21.95
- AE4595.....(Avery Brand)\$32.95

EXTENDED BACK RIVET SETS



2470-12



2470-12D

These extended versions of our 2470 Back Rivet Sets are great to get into confined areas. They are especially useful to RV-10 builders who must back rivet some areas of the fuselage. 12" long, .401 shank.

- 2470-12(12" Straight).....\$27.95
- 2470-12D(12" Double Offset).....\$29.95

BACK RIVETING PLATE



Back riveting requires a hard flat surface to act as a bucking bar while you set the shop head of the rivet. This low carbon steel plate has a flat ground surfaces to help you accomplish the task with minimal effort. 3/8" thick X 4" wide X 15" long.

- AE1065.....\$71.95

HIGH SHEAR RIVET PUNCH

Uses a standard .401 rivet gun to remove High Shear and Huck rivets. Each punch is 3-3/8" long.



PART	SIZE	PRICE	PART	SIZE	PRICE
RP-1/8	1/8"	\$18.95	RP-1/4	1/4"	\$19.95
RP-5/32	5/32"	\$18.95	RP-5/16	5/16"	\$19.95
RP-3/16	3/16"	\$18.95	RP-3/8	3/8"	\$18.95

SWIVEL RUBBER GUARD FLUSH RIVET SET



Safety flush rivet set makes it virtually impossible to damage or "smile" the skin while flush riveting. Rubber outer guard cushions the outer edge of the set while limiting recoil. Swivel head will move through 20 degrees to keep the face of the set flush against the head of the rivet which minimizes mis-setting the rivet. Finally, the safety spring keeps the set securely attached to the rivet gun to prevent accidental "bullets".

- AT106A.....\$57.95

SWIVEL FLUSH RIVET SET



The swiveling face of this rivet set will keep it flush against the head of the rivet even if you are a little off angle reducing the chance of "smiling" the sheet metal or mis-setting the rivet. The 1-1/4" face is highly polished and slightly mushroomed to keep it against the head of the rivet and off the sheet metal. Fits into any .401 shank rivet gun.

- 181.....\$20.95

RUBBER GUARD FLUSH RIVET SET



Flush rivet set with a rubber boot to prevent damage to metal surfaces while riveting. Fits any .401 rivet gun.

- 12A(3/4" Dia.)\$14.95
- 12C(1-1/2" Dia.).....\$21.95

RIVET SET EXTENSION

This rivet set extension has a standard .401 shank. Use with other standard .401 rivet sets for added reach. 8" overall length.

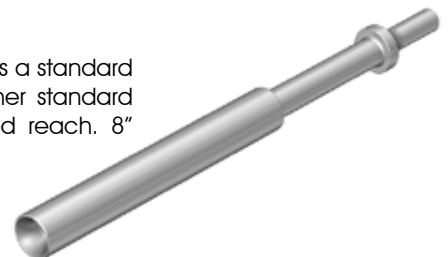

- 128A\$24.95



BENCH MOUNTED DIMPLING/RIVETING TOOL



The deep 22-1/2" reach and 4" clearance height of this tool makes it a favorite of home builders and repair specialists. It's manufactured from heavy duty steel and finished with a rock hard powder-coated enamel for durability and great looks. The precision ground rivet shaft and fitted bronze bushing guarantees a silky smooth operation. And the automatic spring-return feature will make your work easier. Uses dimple and die or rivet sets with a .187" shank. Comes complete with an extension shaft and die holder block. Design extends throat to a 22-1/2" reach for RV and other kit builders.



204RV \$215.95

3M RIVETERS TAPE



Riveters tape saves you time when doing those large riveting jobs by securely holding each rivet in place until you are ready to buck it. Rivets are fully visible through the transparent center window. Leaves no residue upon separation.

685-1 (3/4" Wide x 36 Yards) \$15.95
 685-2 (1" Wide x 36 Yards) \$17.95

BRASS, ALUMINUM AND NYLON PEENS



Peens are great for driving pins, knocking out old rivets, removing dents, nudging things into place, and shaping sheet metal. Select a peen head with a material that is softer than the object you intend to drive to prevent marring. Screw-in heads are made of solid brass, aluminum, or nylon and are interchangeable between body lengths. 1-1/4" diameter. Fits .401" rivet guns and air hammers.

RIVET FAN SPACING TOOL

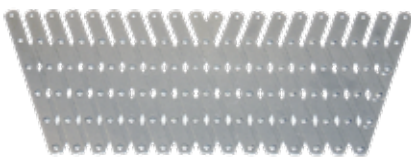

This tool is just what you need for lining up those rivet holes. The clever accordion action of the fan spacer allows you to set up rivet holes with deadly accuracy. Simply expand or contract the tool to get the spacing you're looking for and start laying out your holes. It just doesn't get any easier than this.

FS01 (Standard Spacer) \$37.95
 FS02 (Mini Spacer) \$29.95

ECONOMY BRASS PEEN



A great tool for driving pins or removing small dents. Solid brass head will not damage steel surfaces. 3" long by 3/4" diameter. Head is non-removable.

BP03 \$8.95

PART	PEEN MATERIAL	LENGTH	PRICE
ATS107A-3B	Brass	3"	\$19.95
ATS107A-5B	Brass	5"	\$21.95
ATS107A-7B	Brass	7"	\$25.95
ATS107A-3A	Aluminum	3"	\$19.95
ATS107A-5A	Aluminum	5"	\$21.95
ATS107A-7A	Aluminum	7"	\$25.95
ATS107A-3N	Nylon	3"	\$19.95
ATS107A-5N	Nylon	5"	\$21.95
ATS107A-7N	Nylon	7"	\$25.95
ATS107-B	Replacement Brass Head		\$9.95
ATS107-N	Replacement Nylon Head		\$9.95
ATS107-A	Replacement Aluminum Head		\$9.95



RIVETING EQUIPMENT

AVERY RIVET SQUEEZER SET ASSORTMENT



An assortment of dimple dies and rivet sets.

AE1200450.....	(21 pc)	\$229.95
AE1200555.....	(8 pc)	\$69.95
AE1200560.....	(6 pc)	\$119.95
AE1200565.....	(6 pc Screw Size).....	\$119.95
AE1720.....	(3/8" X 1/16" Set).....	\$7.95
AE1721.....	(3/8" X 1/8" Set).....	\$7.95
AE1723.....	(3/8" X 1/4" Set).....	\$7.95
AE1725.....	(3/8" X 3/8" Set).....	\$7.95
AE1727.....	(3/8" X 1/2" Set).....	\$7.95

AVERY POP DIMPLERS



This pop rivet dimpler is for dimpling in hard to reach places. Works with any hand pop rivet tool. Can be used over & over. Works for both 100 & 120 pop rivets.

AE1022.....	(3/32" Dia).....	\$25.95
AE1024.....	(1/8" Dia).....	\$25.95

DIE SETS FOR SETTING BRAKE RIVETS



Use your hand or pneumatic squeezer to set Cleveland brake rivets when re-lining your brake pads. Includes (2) sets with .187" dia. shank. All you need is a 3/16" drill bit, a small socket, a small pin punch and a hammer. Can also be used to install 1/8" countersunk tubular rivets.

AE4625.....	\$35.95
-------------	---------

WISE® GRIP DIMPLER



Made for dimpling in restricted and hard to reach places where regular dimple dies won't fit. With 7" Vise Grip® plier. Machined tool steel dimple dies are T.I.G. welded to the Vise Grip jaws then polished. Manufactured by Avery Tools.

AE550.....	(3/32").....	\$48.95
AE552.....	(1/8").....	\$48.95

SCREW DIMPLERS



A dimpling tool similar to our pop rivet dimplers, but these use an allen screw to apply the dimpling force. Each size comes with a male and female die, allen screws and nuts and an allen wrench.

PART	SCREW SIZE	PRICE
AE1025	6 Screw	\$27.95
AE1026	8 Screw	\$25.95
AE1027	10 Screw	\$25.95

AVERY SPRING BACK DIMPLE DIE SETS



Spring back dimple dies are precision CNC machined from aircraft quality heat treatable stainless steel & heat treated to Rockwell C42/46. Spring back angles on both dies make a superior dimple. Working surfaces are polished to a satin finish & sharp edges are radii. Manufactured by Avery Tools.

PART	SIZE	PRICE	PART	SIZE	PRICE
AEDDS-3	3/32"	\$40.95	AE6DDS	AN6 Screw	\$38.95
AEDDS-4	1/8"	\$40.95	AE8DDS	AN8 Screw	\$38.95
AEDDS-5	5/32"	\$40.95	AE10DDS	AN10 Screw	\$38.95

RIVETING EQUIPMENT

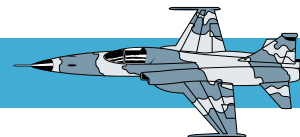

FUEL TANK DIMPLE DIE SET 3/32



Use this dimple die set on fuel tanks. 3/32" dimple dies.

AE14875.....\$40.95

AVEX RIVET DIMPLE DIE SET



120 degree dimple die set is specifically made for Avex Rivets.

AE14877.....(1/8").....\$39.95

AE14879.....(5/32").....\$25.95



RV-14 MODIFIED 3/32" MALE DIE

Male dimple die is modified for use in the RV-14 build.

AE14-3/32.....\$15.95

DIMPLE DIE SETS - 100°



This product is a clever way to set dimple in sheet metal using a pop riveter. Just place both halves on the sheet metal insert in your riveter and squeeze to form a perfect dimple.

5102D-3/32.....\$8.95

5102D-1/8.....\$8.95

HAND DIMPLING PLIERS



Our dimpling pliers are produced from sturdy Vise Grip® Pliers which allow you to clamp down with over 3,500 lbs. of force! This unit sports a 1" reach and uses any standard dimple die with a .187 shank. Just order one pair of pliers and three additional sets of dies and you will have four tools in one!

PART	SIZE	PRICE	PART	SIZE	PRICE
7073	3/32"	\$35.95	707AN6	AN6 Screw	\$35.95
7074	1/8"	\$35.95	707AN8	AN8 Screw	\$35.95
7075	5/32"	\$35.95	707AN10	AN10 Screw	\$35.95
7076	3/16"	\$35.95			

SPRING BACK DIMPLE DIES



The unique shape of a spring back dimple die's face pushes the metal up slightly before the dimple is made, resulting in a cleaner, more precise 100° dimple. All dies are 1/2" in diameter and 1/4" long with a .187" shank.

PART	SIZE	PRICE	PART	SIZE	PRICE
SB4263	3/32"	\$25.95	SB6	AN6 Screw	\$29.95
SB4264	1/8"	\$25.95	SB8	AN8 Screw	\$29.95
SB4265	5/32"	\$25.95	SB10	AN10 Screw	\$29.95

AVERY RV-14 SQUEEZING SAFETY PIN



This tool is made specifically to rivet the RV-14 elevator trailing edge, which unlike other RV kits has the last section of the trailing edge angled upwards by 4 degrees.

AE14-1801.....\$25.95

RIVET EDGE GAUGE



Maintenance standards require that all rivet be no less than 2 diameters (2D) and no more than 4 diameters (4D) from the edge of the sheet, with the optimum distance being 2.5 diameters (2.5D). This tool will accurately gauge the

distance of rivet holes from the edge of the sheet to verify that they are within these standards.

MJ520.....\$12.95

DIMPLE DIE BLOCK SETS

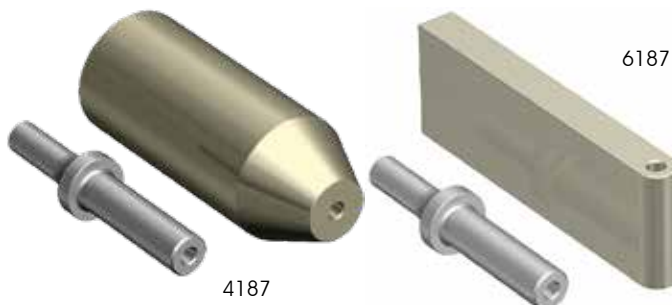

Set accepts any dimple die or rivet squeezer sets with a .187 shank. Shank portion can be used in a standard rivet gun or struck with a hammer.

4187.....\$18.95

6187.....(Corner Block Unit).....\$18.95



RIVETING EQUIPMENT

DIMPLE DIES AND PUNCHES



426XP PUNCH
(MALE)



426XD DIE
(FEMALE)



426DD-KIT

Standard .187 shank. For AN426 series rivets (100 degrees countersink).

PART	SIZE	M/F	BODY LENGTH (L)				PRICE
			1/8"	1/4"	3/8"	1/2"	
4263DP-2	3/32	M&F	-1*	-2	-3	-4	\$17.95
4264DP-2	1/8	M&F	-1*	-2	-3	-4	\$17.95
4265DP-2	5/32	M&F	-1*	-2**	-3	-4	\$17.95
4266DP-2	3/16	M&F	-1*	-2**	-3	-4	\$17.95
4506DP-2	6 Screw	M&F		-2	-3		\$22.95
4508DP-2	8 Screw	M&F		-2	-3		\$22.95
4510DP-2	10 Screw	M&F		-2	-3		\$22.95
426DD-KIT	3/32-3/16	M&F		-2			\$65.95

*Note: these sets consist of a -2 die (F) and a -1 punch (M).

**Note: these sets consist of a -3 die (F) and a -2 punch (M).

RIVET SQUEEZER SETS



470X SERIES



4710 SERIES

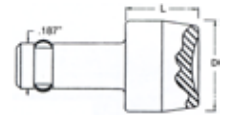

200-X SERIES



200-450X SERIES



3456-X

UNIVERSAL RIVETS (AN470) STANDARD .187 SHANK							
PART	DIA (D)	RIVET SIZE	BODY LENGTH (L)				PRICE
			1/8"	1/4"	3/8"	1/2"	
4703-2	1/2"	3/32	-1	-2	-3	-4	\$6.95
4704-2	1/2"	1/8	-1	-2	-3	-4	\$6.95
4705-2	1/2"	5/32	-1	-2	-3	-4	\$6.95
4706-2	1/2"	3/16	-1	-2	-3	-4	\$6.95
4710-2	1/2"	Flush	-1	-2	-3	-4	\$6.95
3456-2	1/2"	6 piece set: 3/32 to 3/16 plus 2 flush	-1	-2	-3	-4	\$29.95
3710-2	3/8"	Flush	-1	-2	-3	-4	\$6.95

SEMI-TUBULAR RIVETS (AN450) STANDARD .187 SHANK					
OVAL			FLARE		
PART	SIZE	PRICE	PART	SIZE	PRICE
200-2	1/16"	\$17.95	200-4502	1/16"	\$20.95
200-3	3/32"	\$16.95	200-4503	3/32"	\$20.95
200-4	1/8"	\$17.95	200-4504	1/8"	\$19.95
200-5	5/32"	\$17.95	200-4505	5/32"	\$20.95
200-6	3/16	\$16.95	200-4506	3/16"	\$26.95
200-8	1/4"	\$16.95	200-4508	1/4"	\$20.95

RIVET SQUEEZER/DIMPLE DIE MIX



A complete set of rivet squeezers and dimple dies for AN470 and Flush riveting. 17 piece set.

PART	DESCRIPTION	QTY	PART	DESCRIPTION	QTY
4703-2	3/32" Squeezer Set	1	4263DP-2	3/32" Dimple Die	1
4704-2	1/8" Squeezer Set	1	4264DP-2	1/8" Dimple Die	1
4705-2	5/32" Squeezer Set	1	4265DP-2	5/32" Dimple Die	1
4706-2	3/16" Squeezer Set	1	4266DP-2	3/16" Dimple Die	1
4710-2	Flush Set (1/2")	2	06785	Set Holder	1
3710-2	Flush Set (3/8")	2			

SKT17\$119.95

DIMPLE DIE AND SQUEEZER SET HOLDER

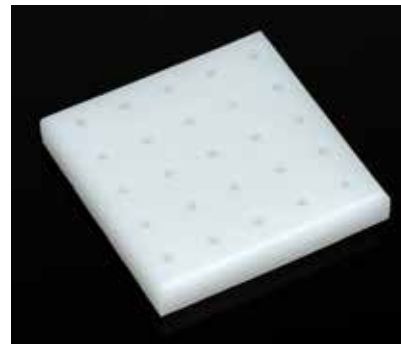

Designed to securely hold up to 25 dimple dies and rivet squeezer sets. Made of high impact plastic. Size is 4" x 4" x 5/8" 25 holes.

3456-B..... (6 Holes) \$3.95
 06785D (8 Holes) \$4.95
 06785..... (25 Holes) \$11.95



PNEUMATIC BENCH MODEL RIVET SQUEEZERS

0214-30C-C120B



0214-60C-C120B



BENCH MOUNT UNITS COME WITH FOOT CONTROL

All units come equipped with an adjustable lower set holder, bench mounting brackets, and hoses. Accepts all squeezer sets with a .187" shank. Available in a variety of yokes and power units. Made in U.S.A.

PART	FORCE	RIVET CAP.	YOKE REACH	YOKE GAP	PRICE
0214-30C-C60B	Single	1/8"	6"	3-1/2"	\$1,627.95
0214-30C-C120B	Single	1/8"	12"	4"	\$3,097.95
0214-60C-C60B	Double	3/16"	6"	3-1/2"	\$2,199.95
0214-60C-C90B	Double	3/16"	9"	3-1/2"	\$2,695.95

RIVET SQUEEZER BENCH MOUNT



Adapt your pneumatic "C" rivet squeezers for bench use. Machined steel bracket mounts to your bench permanently while allowing you to easily install or remove the riveter. The unique design clamps any yoke in any position from straight to tilted back 90 degrees. Works with all (9/16" thick) pneumatic squeezer yokes.

AE7698 \$71.95

RIVET SPACER SHIM KIT



Spacer shims are used with Compression Riveters to produce a precise rivet gap spacing. This kit contains 2 each of the following shim sizes: 1/64", 1/32", and 1/16". With it you will be able to make 1/64" adjustments in a range of 1/64" to 7/32".

SMS-012K \$8.95

ADJUSTABLE SET HOLDER FOR PNEUMATIC SQUEEZER



This adjustable set holder will eliminate the need to shim the dies and sets with shim washers. Adjustments are faster and easier. Note: Only for yokes with 1" thick base or less. Does not work for tandem units.

AE274 (Avery Brand) \$82.95

214CAR (ATS Brand) \$49.95



RIVET SQUEEZERS

ATS PNEUMATIC "C" SQUEEZER



SINGLE FORCE
ATS-114CK



DOUBLE FORCE
ATS-214CK

The "C" squeezer is by far the most popular pneumatic type riveter. They are also the most versatile. With a wide array of yokes to choose from, there is practically no riveting job they cannot take on. That's why we decided to create our own version of this popular squeezer. Our new ATS "C" Squeezer is lightweight and has the same power as the Chicago Pneumatic 0214-C squeezer on which it is based. It accepts the same yokes and attachments and is powerful enough to squeeze up to 1/8" solid aluminum, or 3/32" solid steel rivets (single force), or up to 3/16" aluminum and 1/8" steel rivets (double force). And we've combined our new riveter with a Longeron yoke, and our best-selling 17-piece squeezer/dimpler set to provide you with a value package that's hard to beat.

DESCRIPTION	SINGLE FORCE (1/8" MAX)		DOUBLE FORCE (3/16" MAX)	
	PART NUMBER	PRICE	PART NUMBER	PRICE
Complete kit with Rivet Squeezer, 1-1/2" yoke, Longeron yoke and Dimple and Squeezer sets	ATS-114CK	\$699.95	ATS-214CK	\$859.95
Rivet Squeezer only with 1-1/2" yoke	ATS-114C-15	\$519.95	ATS-214C-15	\$689.95
Rivet Squeezer only with 3" yoke	ATS-114C-30	\$539.95	ATS-214C-30	\$709.95

"C" SQUEEZER YOKES

		LONGERON					
A = 2.5", B = 1.25"		A = 1.0", B = 1.0"		A = 1.19", B = 1.25"		A = 2.5", B = 1.375"	
14-10 \$105.95		14-1 \$68.95		14-2 \$69.95		14-5 \$125.95	
A = 2", B = 1.25"		A = 3.0", B = 1.375"		A = 5.625", B = 1.25"		A = 1.5", B = 1.25"	
14-4 \$105.95		14-7 \$135.95		14-9 \$155.95		14-3 \$69.95	
A = 2.75", B = 1.25"		A = 3.875", B = 1.25"					
14-6 \$125.95		14-8 \$145.95					

RIVET SQUEEZERS



ATS PNEUMATIC ALLIGATOR SQUEEZER



SINGLE FORCE
ATS-114AK



DOUBLE FORCE
ATS-214AK

The new ATS Alligator Squeezer is a lightweight, compact, and powerful riveter modeled after the industry standard Chicago Pneumatic Q214-A squeezer. It accepts the same attachments and jaws designed for that unit. The single piston version delivers 3,000 lbs of force to squeeze up to 1/8" solid aluminum, or 3/32" solid steel rivets. And the tandem model uses a double piston arrangement to deliver up to 6,000 pounds of force to squeeze up to 3/16" aluminum, or 1/8" steel rivets. This is a riveter that will easily fit most of your riveting needs without breaking your budget. Want even more savings? Get the complete riveting kit, which contains the alligator squeezer, plus our 17-piece squeezer/dimpler set priced at a substantial discount.

DESCRIPTION	SINGLE FORCE (1/8" MAX)		DOUBLE FORCE (3/16" MAX)	
	PART NUMBER	PRICE	PART NUMBER	PRICE
Complete kit with Alligator Squeezer, 1-1/2" jaws, and Dimple and Squeezer sets	ATS-114AK	\$669.95	ATS-214AK	\$749.95
Alligator Squeezer only with 1-1/2" jaws	ATS-114A-15	\$599.95	ATS-214A-15	\$659.95
Alligator Squeezer only with 3" jaws	ATS-114A-30	\$769.95	ATS-214A-30	\$899.95

PNEUMATIC ALLIGATOR COMPRESSION RIVETERS

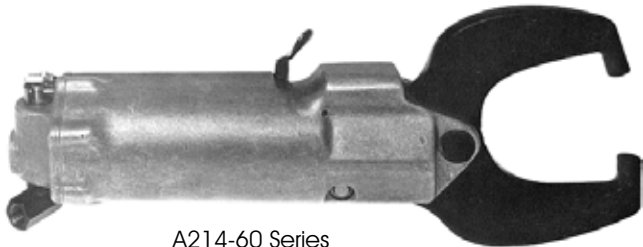

A214-60 Series

Alligator "A" Riveters are designed to be used in areas not accessible by other riveting methods. Our riveters are completely interchangeable with Chicago Pneumatic Squeezers. All Riveters will accept any Squeezer Set with .187" shank.

PART	FORCE (LBS)	CAPACITY	REACH	PRICE
A214-60-A15	6000	3/16"	1-1/2"	\$821.95
A214-60-A22	4600	5/32"	2-1/4"	\$861.95
A214-60-A30	3400	1/8"	3"	\$885.95

More options available online at www.aircraft-tool.com



RIVET SQUEEZERS

ATS PROFESSIONAL SWIVEL HAND RIVET SQUEEZER



RS-BK



5022-3A



This is our most popular rivet squeezer, and our customers love it because its heavy duty design will hold up to even the most brutal punishment. The handles are formed from .060" thick cold-rolled steel tubing that resists bending, even under heavy pressure. The ram assembly is engineered to operate smoothly while delivering the maximum possible leverage without breaking - in fact, our ram assembly has been tested to 6,000 lbs without any indication of failure! And finally, the yoke head is precisely CNC machined from solid steel and case-hardened for extra toughness. We made this squeezer to last a lifetime, and our Ats Pro Lifetime warranty guarantees it!

5011-1A	(Squeezer with 1-1/2" Yoke)	\$145.95
5022-3A	(Squeezer with 3" Yoke).....	\$155.95
RS1009A-1	(Replacement 1-1/2" Yoke).....	\$65.95
RS1008A-3	(Replacement 3" Yoke).....	\$75.95
RS-BK	(Bench Mount Only)	\$58.95

ATS ECONOMY RIVET SQUEEZER KIT



ATSRS-KIT

Our ATS Series Rivet Squeezer will safely squeeze aluminum rivets up to 5/32" in diameter (up to 1/8" steel rivets). The unibody handles are forged from a single billet of steel and precisely machined. This makes them extremely strong and resistant to breakage. The yoke is made of the highest quality tool steel and hardened to resist flex under stress. An adjustable ram eliminates the need for shims.

This popular economy rivet squeezer kit is ideally suited for the home builder or the occasional user. It features our ATSRs economy rivet squeezer with a selection of 3 yokes in sizes 1, 2, and 3 inches. We've also thrown in our 6 Piece Squeezer Set, and a set of Rivet Gauges to help you get the job done right. Our ATS Rivet Squeezer will easily squeeze rivets up to 5/32" diameter. The yokes are made of tool steel and hardened to resist flex. Adjustable ram eliminates the need for shims.

ATSRs-KIT.....	(Complete Kit)	\$179.95
ATSRs-1	(1" Rivet Squeezer Only).....	\$92.95
ATSRs-3	(3" Rivet Squeezer Only).....	\$100.95
ATSRs-1Y	(1" Yoke).....	\$29.95
ATSRs-2Y	(2" Yoke).....	\$39.95
ATSRs-3Y	(3" Yoke).....	\$43.95

RIVET SQUEEZERS



DELUXE HAND/BENCH RIVET SQUEEZER KIT



The ATS Hand/Bench Rivet Squeezer Kit gives you the best of both worlds. It's a hand squeezer that converts to a free-standing bench squeezer in under 10 seconds! To make sure you can handle any riveting job, we included a 3" yoke in addition to our 1 1/2" squeezer. You'll also get the bench mounting kit and our 17 piece squeezer and dimple die assortment set (SKT17).



Scan to view video

Swivels a full 360° to rivet from any direction!



5022-DX.....(Complete Kit) \$349.95

SPECIALTY YOKES



RS1005A



RS1007A



RS1006A



RS1004A

Our specialty yokes adds even more versatility to our popular 5022-DX, 5022, and 5011 Rivet Squeezers. Each yoke is heat treated and precision CNC machined in Michigan. Gap height 1 1/4".

RS1004A.....(2 1/2" Longeron Yoke) \$95.95
 RS1005A.....(4" Deep Reach Yoke) \$99.95
 RS1006A.....(1 1/2" Close Quarter Yoke) \$75.95
 RS1007A.....(3" Close Quarter Yoke) \$79.95



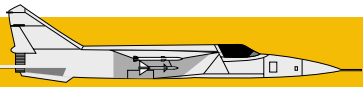

RIVET SQUEEZERS

ATS SUPER DUTY RIVET SQUEEZER KIT



This top model of our exclusive ATS squeezer line is built for hard use, making it a perfect shop addition. The super duty squeezer is constructed out of stainless steel and the unique unibody styling is drop forged giving it extra strength and CNC machined to tight tolerances. The stainless steel yokes are specially engineered to be half the weight of other yokes, but maintains it's full strength. Our Pro squeezer has an adjustable ram, eliminating the need for shims. This squeezer will work on rivets up to 5/32" aluminum (1/8" steel), and will accept any rivet sets and dimple dies with a standard 3/16" (.187) shank. We guarantee this Pro Super Duty squeezer will last a lifetime, and back it with our ATS Lifetime Warranty.

Our money-saving kit contains everything you'll need to tackle any riveting job. You get our popular ATSRs-3SD 3" Rivet Squeezer, an extra 1.5" yoke, our 17 Piece Dimple Die and Squeezer Set, a Rivet Length Gauge, and a Shop Head Rivet Gauge to help you get the job done right.

SDRS-KIT	(Complete Kit)	\$279.95
ATSRs-1SD	(1.5" Squeezer Only)	\$115.95
ATSRs-3SD	(3" Squeezer Only)	\$130.95
ATSRs-1SDY	(1.5" Yoke)	\$39.95
ATSRs-3SDY	(3" Yoke)	\$52.95



DIMPLE DIE AND SQUEEZER SET

A collection of squeezer sets and dimple dies.

SKT17	(17 Piece)	\$119.95
3456-2	(6 Piece Squeezer Set)	\$29.95
426DD-KIT	(9 Piece Dimple Die)	\$65.95

We back everything we sell with the Ultimate Aircraft Guarantee!

- A Pro Life Time Warranty that cant be beat.
- An experienced staff to answer your tough questions.
- Unmatched Customer Service.
- 30 Day money back guarantee.

POWER RIVETERS



CHERRY® POWER RIVETERS

Note: Pulling heads are not furnished with Riveters and must be purchased separately.

G704B CHERRYMAX® POWER RIVETER



This tool utilizes straight, offset and right-angle pulling heads, all of which can install -4, -5, and -6 diameter CherryMAX® rivets in all head styles, materials and grip lengths. Specifications: 90 to 110 PSI (6.2 to 7.6 bar) operating pressure; 3100 lbs (13.79 kN) pulling force at 90 psi (6.2 bar); .510" (12.954mm) stroke length; 4.25 lbs (1.93 kg) weight.

See the Power Riveter section of this catalog for the following recommended Nosepieces: H701B-456 Straight, H753-456 Right Angle, and H781-456 Offset for CherryMAX®.

G704B(NSN 5130-01-044-7207)..... \$1,183.95
 GBP704F(GBP Brand)..... \$1,144.95

G784 CHERRYLOCK® HYDRO-SHIFT RIVETER



It will install nearly all diameters of CherryLOCK® Rivets up to a half-inch grip. It can be operated in any position with one hand. With proper adapters and pulling heads, this tool will install other types of rivets including CherryMAX® Rivets. Specifications: 90 to 110 PSI (6.2 to 7.6 bar) operating pressure; 2600 lbs (11.57 kN) pulling force at 90 psi (6.2 bar); .875" (22.2mm) stroke length; 8 lbs (3.63 kg) weight.

See the Power Riveter section of this catalog for the following recommended Nosepieces: H681-3C, -4C, -5C, and -6C for CherryLOCK®; H680B200A and 744-300 adapter for CherryMAX®.

G784(NSN 5130-00-935-4681)..... \$4,195.95
 GBP784B.....(GBP Brand)..... \$3,198.95

G747 CHERRYMAX® POWER RIVETER



This tool utilizes straight, offset and right-angle pulling heads, all of which can install -4, -5, and -6 diameter CherryMAX® bulb type rivets in all head styles, materials and grip lengths. Specifications: 90 to 110 PSI (6.2 to 7.6 bar) operating pressure; 2100 lbs (9.34 kN) pulling force at 90 psi (6.2 bar); .437" (11.1 mm) stroke length; 3.5 lbs (1.59 kg) weight.

See the Power Riveter section of this catalog for the following recommended Nosepieces: H701B-456 Straight, H753-456 Right Angle, and H781-456 Offset for CherryMAX®.

G747 \$1,157.95

G83 CHERRY LOCKBOLT POWER RIVETER



This a heavy duty production tool designed for high speed, reliable installation of the most popular sizes of aircraft lockbolts. It can be operated in any position with one hand. This tool can also be used to install blind bolts and blind rivets. Specifications: 90 to 110 PSI (6.2 to 7.6 bar) operating pressure; 3750 lbs (16.7 kN) pulling force at 90 psi (6.2 bar), 800 lbs (3.56 kN) on return stroke; .438" (11.1mm) stroke length; 4.95 lbs (2.25 kg) weight.

See the Power Riveter section of this catalog for the following recommended Nosepieces: H701B-456 for CherryMAX®.

G83A.....(NSN 5130-01-435-3507)..... \$1,872.95

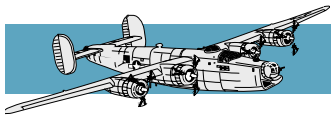

POWER RIVETERS

G84 LOCKBOLT POWER RIVETER



- Stroke: 9/16"
- Pulling Force: 5, 750 lbs (2,608 kgs)

The G84 pneumatic-hydraulic tool is a heavy-duty production tool designed for high speed, reliable installation of the most popular sizes of aircraft Lockbolts. Its durable, all metal housing makes this tool ideal for use in rugged shop environments.

G84 **\$1,885.95**

CHERRYLOCK PULLING HEADS



The H681 series pulling heads are used to install 2000 series Cherrylock® rivets. A separate pulling head is required for each diameter and type of rivet. Fits GBP models GBP700 and GBP784, and Cherry Textron models G700 and G784 riveters.

PART	SIZE	PRICE
H681-3C	3/32"	\$549.95
H681-4C	1/8"	\$479.95
H681-5C	5/32"	\$479.95
H681-6C	3/16"	\$475.95

OFFSET CHERRYMAX PULLING HEAD



Offset nosepieces are used to clear obstructions that are in line with the normal pulling axis of the riveter. This pulling head provides an offset of 1-15/32". Overall length is 4-3/8". Pulls all nominal and oversize Cherrymax® rivets from 1/8" (-4) to 3/16" (-6). Works with the following riveters: GBP model GBP704, Cherry Textron models G747, G704B, and G746A

H781-456 **\$550.95**

RIGHT ANGLE CHERRYMAX PULLING HEAD



A right angle nosepiece pulls at 90° to the normal pulling axis of the riveter. They are used in restricted areas, or when pulling from around a corner. The H753-456 has a head clearance of 2-1/4", and an overall length of 5-7/16". Pulls all nominal and oversize Cherrymax® rivets from 1/8" (-4) to 3/16" (-6). Works with the following riveters: GBP model GBP704, Cherry Textron models G747, G704B, and G746A.

H753-456 **\$787.95**

BLIND BOLT PULLING HEADS



These pulling heads will fit Cherry G83 and G84 Riveters and allow you to pull Cherry MaxiBolt®, Huck A286, MS90353, MS90354, MS21140, and MS21141 Blind Bolts. The Cherry® and Huck® Pulling Heads shown below are compatible for a given size, and may be used interchangeably with corresponding Huck or Cherry Riveters.

PART	SIZE	DESCRIPTION	MFG	PRICE
H83B-5MB 99-2701	-5	5/32" Pulling Head	Cherry Huck	\$682.95 \$527.95
H83B-6MB 99-2707	-6	3/16" Pulling Head	Cherry Huck	\$682.95 \$566.95
H84C-8MB 99-2713	-8	1/4" Pulling Head	Cherry Huck	\$915.95 \$559.95

STRAIGHT CHERRYMAX PULLING HEADS



FIGURE A



FIGURE B

A straight nosepiece is the preferred way to install Cherrymax® rivets if circumstances permit. Each nosepiece listed in the chart below will pull all nominal and oversize Cherrymax® rivets from 1/8" (-4) to 3/16" (-6).

PART	FIG	FITS RIVETER		PRICE
		GBP MODEL	CHERRY MODEL	
H701B-456	a	GBP704	G704B,	\$153.95
H680B200A	b	GBP700,	G700	\$499.95
456MAX744-20	b	GBP784	G700, G784	\$409.95
08MAX744-20	b	GBP744	G744	\$419.95

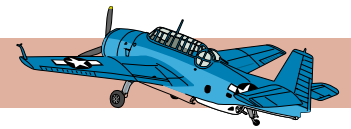

ATS AIR HYDRAULIC RIVETER KIT



- Pulls 3/32", 1/8", 5/32", and 3/16" rivets.
- Includes Stem Catcher
- 2300 lbs pulling force
- .63" Stroke length.

Accessory Kit Contains: An assortment of 40 pop rivets in sizes 3/32", 1/8", 5/32", and 3/16"; 1 set replacement o-rings and seals (1); Oil Bottle; replacement spring set (3); replacement valve pusher; replacement jaws and jaw case; wrench set; high impact molded case.

This heavy duty riveter is designed to take on any job from home built to production work. Features two level hydraulic system to deliver over 1 ton pulling force, and has a long .63 inch stroke. Also features a built in stem deflector to keep work area clean.

- ATS8805K.....(Complete Kit).....\$119.95
- ATS8806..... (Heavy Duty Riveter)\$95.95
- 3047RP.....(Replacement Jaws).....\$13.95
- ATS8806-SET..... (Replacement Nosepiece Set)\$10.95

ATS 1/4" AIR HYDRAULIC RIVETER



- Pulling Force 3,500 lbs (1,603 Kg)
- Rivet Capacity 1/4" aluminum or mild steel
- Stroke Length .55" (14 mm)
- Nosepieces: 3/32" (2.4 mm), 1/8" (3.2 mm), 5/32" (4.0 mm), 3/16" (4.8 mm), 1/4" (6.4 mm)
- Full 1-year warranty

The newest addition to our air riveter line delivers a massive 3,500 lbs of force to effortlessly pull up to 1/4" aluminum and steel rivets. It's made to the same quality standards as all of our other, aviation grade riveters and comes with a full 1 year warranty. The complete package contains the riveter, 2 jaw cases (light duty and heavy duty), 4 nosepieces, a set of spanners, and a stem deflector for added safety. Great for pulling Cherry, Avdel, and Pop rivets.

- ATS8808..... (Unit Only)\$175.95

ATS EXTENDED REACH RIVETER WITH COLLECTOR



- Pulling Force 1,300 lbs (600 Kg)
- Rivet Capacity 5/32" aluminum or mild steel
- Stroke Length .63" (16 mm)
- Extended nose dimensions: 8.00" long x .635" diameter
- Nosepieces: 3/32" (2.4 mm), 1/8" (3.2 mm), 5/32" (4.0 mm)
- Built-in vacuum collection system
- Weight 2.7 lbs (1.2 kg)

This specialty riveter is for reaching into those really deep areas. Vacuum collection system keeps stems safely stowed in collector.

- ATS8814VE.....\$275.95

ATS HEAVY DUTY RIVETER WITH COLLECTOR



- Pulling Force 2400 lbs (1090 Kg)
- Rivet Capacity 3/16" aluminum or mild steel
- Stroke Length .768" (19 mm)
- Built-in vacuum collection system
- Nosepieces: 3/32" (2.4 mm), 1/8" (3.2 mm), 5/32" (4.0 mm)
- Weight 4.11 lbs (1.87 kg)

This riveter is designed for high capacity work. Its short cycle time and long stroke length makes easy work of pulling even the most challenging blind rivets. The ergonomic design which features rubber grip, and low force tripper mechanism means that you can use it for hours without fatigue. A built in vacuum system will keep stems contained in the collector, keeping the workspace free of debris.

- ATS8821V.....\$229.95

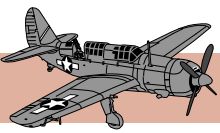

BLIND RIVETERS

ATS INLINE RIVETER WITH COLLECTOR

This riveter gets you into some very tight spaces. It's unique in line configuration allows you to use it to do construction or repairs through openings such as inspection holes or wheel wells.

- Pulling Force 2400 lbs (1090 Kg)
- Rivet Capacity 3/16" aluminum or mild steel
- Stroke Length .768" (19 mm)
- Built-in vacuum collection system
- Nosepieces: 3/32" (2.4 mm), 1/8" (3.2 mm), 5/32" (4.0 mm)
- Weight 4.11 lbs (1.87 kg)



ATS8802V..... \$249.95
ATS8802V-04..... (Replacement Jaws)..... \$249.95

ATS MONOBOLT RIVETER

With heavy duty jaws and a pulling force of nearly 4,000 lbs, the new ATS Monobolt Riveter will easily draw 3/16" and 1/4" diameter rivets. Suitable for use with Avdel Monobolts® (27xx series), and Huck Magna-Loks® (MGL and UMGL series).

- Pulling Force 3,841 lbs (1,745 Kg)
- Rivet Capacity 1/4" aluminum or mild steel
- Heavy Duty Jaws
- Nosepieces: 3/16" (4.8 mm), 1/4" (6.4 mm)
- Weight 3.85 lbs (1.75 kg)



ATS8813..... \$345.95

ATS HEAVY DUTY LOCKBOLT RIVETER



- Pulling Force 4,100 lbs (1,860 Kg)
- Stroke Length .9" (23 mm)
- Pulls 3/16" (4.8 mm) & 1/4" (6.4 mm) Lockbolts
- Weight 6.38 lbs (2.9 kg)
- Requires 90 PSI at 3 CFM
- Includes stem deflector

Powerful air-hydraulic riveter is designed specifically to install two-piece lockbolt fasteners of all types, including Avdel MaxLok, Huck Lockbolts, and Pop Lockbolts.

ATS8921..... \$1,259.95

HUCK® AIR POWERED RIVETER



The AK175A is the air powered counterpart to the HK150A. It is the most compact air-reciprocating hydraulic riveter on the market. It will pull Cherrymax® rivets in 5/32" and 3/16" sizes. It will also pull Pop® and Monobolt® rivets (Monobolt nosepieces are sold separately).

AK175A \$409.95
202168.....(3/16" Monobolt Nosepiece) \$20.95
202169.....(1/4" Monobolt Nosepiece)..... \$20.95
3047RP..... (Replacement 2-Piece Jaw Set) \$13.95
202929.....(Replacement 3-Piece Jaws Set) \$25.95
HKRN205(Rivnut Conversion Kit) \$169.95

HUCK® HAND HYDRAULIC RIVETER



The HK150A features a moveable jaw design which allows it to pull 1/8", 5/32", and 3/16" Cherrymax® rivets without any additional attachments. It will also pull many other types of blind rivets ranging from simple Pop® rivets to sophisticated Monobolts® in sizes ranging up to 1/4" steel rivets.

HK150A \$272.95
202929..... (Replacement 3-Piece Jaws) \$25.95
HKRN205(Rivnut Conversion Kit) \$169.95



AIR HYDRAULIC BLIND RIVETER



Reacting to the need for a high production quality blind riveter with the ability to install both aerospace and industrial quality blind rivets, FSI is pleased to offer the PT-202F air hydraulic riveter. Coupling aerospace quality pneudraulic components with a well established and user friendly blind rivet nose assembly, the PT-202F offers a perfect complement to our line of limited production, field maintenance and repair riveters. Ergonomically balanced and weighing only 5.8 lbs the

rugged metal housing will offer years of service in both high production and harsh field maintenance environments.

PT-202F..... **\$1,780.95**

HAND HYDRAULIC RIVETER



The D-100C will install blind rivets up to 1/4" diameter (including , Monobolts®, and Huck Magna-Lok®) and blind rivet nuts up to 3/8" Aluminum and 1/4-20" or 6mm steel.

D-100C **\$310.95**

CHERRY TEXTRON™ BLIND RIVETER



Cherry Textron hand riveter is ideally suited for installing Cherry-Q, Pop Rivets, or Avex Rivets in sizes 1/8" through 3/16"

aluminum or up to 1/8" steel rivets. Includes nose pieces for 1/8", 3/16", and 5/32" rivets. Length: 9-1/4".

G28..... **\$149.95**



CORDLESS BLIND RIVETER KIT



The new higher capacity PT-4000 cordless blind riveter offers the sheet metal technician capability for installation of most all 1/4" diameter blind rivets while retaining all the features of the PT-3000 with respect to size, weight and versatility. Falling within the USAF TO-1-1-688 spec, the PT-4000 develops in excess of 4,000 lbs of pulling force over more than 3/4" of stroke. Utilizing the same battery packs and charger as the PT-3000 riveter, the PT-4000 is a logical addition for any organization normally requiring 1/4" diameter blind riveting capability.

PT-4000C..... **\$1,780.95**

CORDLESS BLIND RIVETER



With more than 1900lbs. of pulling force the PT-3000C is able to install single action blind rivets from 3/32" thru 3/16" diameter and 1/4" aluminum Pop type rivets. So whether you are doing skin repairs, or full aircraft production the PT-3000C will make our riveting job much easier and quicker.

PT-3000C..... **\$1,570.95**

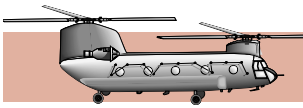

BLIND RIVETERS

SWIVEL BLIND RIVETER

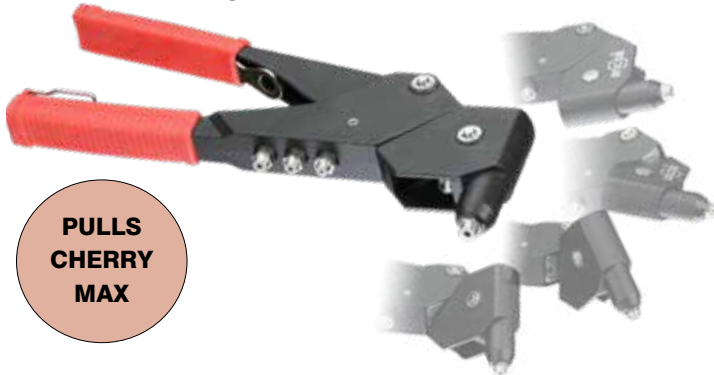

**PULLS
CHERRY
MAX**

This riveter has a swivel head which rotates a full 360° for versatility. This riveter will double as a 90° offset riveter, or a straight (in line) puller just by rotating the head. Pulls up to 3/16" Cherrymax® and many other blind rivets without any additional attachments.

36021.....\$37.95

CLOSE QUARTERS POP® RIVETER



Close quarters POP® brand riveter features an offset nosepiece for easy access to corners and close to wall applications. Sets rivets from 3/32" to 5/32" diameter. Includes nosepiece to set 1/8" rivets.

PRP-26A.....\$188.95

AVERY RV-12 CORNER RIVET PULLER ASSISTANT



Designed for RV-12 rivets that get pulled in close quarter or corner applications. Turned up angle at 10 degree to shift pop rivet stem and puller away from corner.

AE5012.....\$17.95

13" HEAVY DUTY HAND RIVETER



This hand riveter features a compound lever action that reduces operator fatigue. With a spent mandrel cup to keep your work area clean, and the ability to pull stainless steel rivets makes it a great addition to your toolbox. For rivets: 1/8, 5/32, 3/16, & 1/4"

15050.....\$44.95

MARSON® HEAVY-DUTY RIVNUT INSTALLER KIT



Industrial strength Rivnut tool is made from forged steel to withstand hard use. Unique design allows mandrels to be replaced quickly and easily. Kit includes mandrels and an assortment of Rivnuts for the following sizes: 6-32, 8-32, 10-32, 10-24, 1/4-20, 5/16-18, and 3/8-16.

39313..... (Rivnut Kit).....\$99.95
M39354..... (Replacement 6-32 Mandrel).....\$15.95
M39355..... (Replacement 8-32 Mandrel).....\$15.95
M39357..... (Replacement 10-32 Mandrel).....\$15.95
M39358..... (1/4-20 Mandrel).....\$17.95
M39371..... (1/4-28 Mandrel).....\$17.95

RIVNUT INSTALLER KIT



Our most popular rivnut installer kit contains everything you need to install rivnuts in sizes 6-32, 8-32, 10-32, and 1/4-20. The (pop rivet) style action makes installing rivnuts as easy as installing a pop rivet.

20RNK.....\$65.95
20RNK-6-32..... (Replacement 6-32 Mandrel).....\$12.95
20RNK-8-32..... (Replacement 8-32 Mandrel).....\$12.95
20RNK-10-32..... (Replacement 10-32 Mandrel).....\$12.95

BLIND RIVETERS



MARSON® DELUXE POP RIVETER KIT



The Marson HP-2 is the number one selling hand rivet tool in the industry. Known and trusted for durability, quality and performance, the HP-2 is often copied but never duplicated. The HP-2 sets up to 3/16" steel rivets and comes with four mounted nosepieces (3/32", 1/8", 5/32" and 3/16") and a service wrench.

The deluxe hand riveter kit includes the Marson HP-2 riveter, tool, wrench, removable nosepieces for 3/32", 1/8", 5/32" and 3/16" riveting, plus an assortment of over 200 assorted Alcoa Klik-Fast rivets: 40 each SB4-2, SB4-4, AB4-2A; 25 each SC4-4, AB6-2. Also includes a molded plastic case.

- 200KT(Complete Kit)..... \$62.95
- HP-2.....(Riveter Only)..... \$39.95

POP RIVNUT INSTALLER



Convert your conventional hand pop riveter into an economical Rive-Nut installer tool.

- R290-6-32(Installs 6-32 Rive-Nuts)..... \$11.95
- R290-8-32(Installs 8-32 Rive-Nuts)..... \$11.95
- R290-10-32(Installs 10-32 Rive-Nuts)..... \$11.95

RIVNUTS



Aluminum "notchless" threaded nut. Grip length of .010 to .075 inches. Sold in packages of 10 pieces.

- RIVNUT-6(6-32)..... \$2.95
- RIVNUT-8(8-32)..... \$3.95
- RIVNUT-10(10-32)..... \$3.95
- RIVNUT-1/4-20(1/4-20)..... \$3.95

HAND RIVNUT INSTALLER

Unit is simple to use and allows an inexpensive, efficient means for installing Rivnuts.



- RN190-6-32.....(Installs 6-32 Rive-Nuts)..... \$25.95
- RN190-8-32.....(Installs 8-32 Rive-Nuts)..... \$25.95
- RN190-10-32.....(Installs 10-32 Rive-Nuts)..... \$25.95

RIVNUT TOOL



The Rivnut Tool is an inexpensive alternative to industrial drivers. It's design enables the rivnut to be seated tighter than with conventional tools. Compact design takes up less room in your tool box. Complete kit contains driver, plus mandrels for 6-32, 8-32, and 10-32 Rivnuts.

- RNT01 \$26.95

SPEED DRIVER RIVNUT INSTALLER

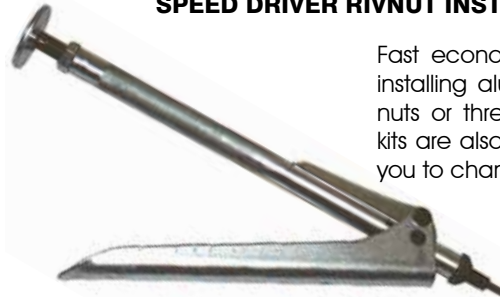

Fast economical hand tool for installing aluminum or steel Rivnuts or thread-sets. Conversion kits are also available that allow you to change the tool size.

INSTALLATION TOOL			
PART		PRICE	
C50-6000-4X40		\$159.95	
C50-6000-6X32		\$159.95	
C50-6000-8X32		\$159.95	
C50-6000-10X32		\$197.95	
C50-6000-10X24		\$159.95	
CONVERSION KIT		REPL. MANDREL	
PART	PRICE	PART	PRICE
C50-4X40	\$45.95	C5000-4X40	\$29.95
C50-6X32	\$45.95	C5000-6X32	\$29.95
C50-8X32	\$45.95	C5000-8X32	\$29.95
C50-10X32	\$45.95	C5000-10X32	\$29.95
C50-10X24	\$45.95	C5000-10X24	\$29.95

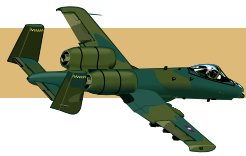

SHEET METAL FASTENERS

CLECO KIT



Our cleco kit comes with an assortment of clecos (0 to .25" grip range) plus a pair of cushioned cleco pliers packaged in a convenient storage case. The 50 piece kit contains 13 ea. of the 3/32" (silver), and CL-1/8 (copper) clecos; plus 12 ea of the 5/32" (black), and 3/16" (gold) clecos. The 100 piece kit contains 25 each of the 3/32", 1/8", 5/32", and 3/16" clecos.

CL50K.....(50 Piece Kit).....\$31.95
CL100K.....(100 Piece Kit).....\$59.95

CLECO FASTENERS



Used to temporarily hold panels and fixtures in place prior to riveting. Standard size (2"x 3/8"). 70 lbs pulling force.

PART	SIZE	GRIP	PRICE
CL-3/32	3/32"	0-1/4"	\$0.49
CL-1/8	1/8"	0-1/4"	\$0.49
CL-5/32	5/32"	0-1/4"	\$0.49
CL-3/16	3/16"	0-1/4"	\$0.49
CL-1/4	1/4"	0-1/4"	\$1.35
EXTRA LONG SERIES			
KHD-3/32	3/32"	0-1/2"	\$1.35
KHD-1/8	1/8"	0-1/2"	\$1.35
KHD-5/32	5/32"	0-1/2"	\$1.35
KHD-3/16	3/16"	0-1/2"	\$1.35

CLECO FASTENERS "SPECIAL"

Order pre-packaged clecos for additional savings. Each package contains 25 pieces of our standard clecos.

25CL-3/32(25 Pieces CL-3/32 Clecos).....\$11.95
25CL-1/8(25 Pieces CL-1/8 Clecos).....\$11.95
25CL-5/32(25 Pieces CL-5/32 Clecos).....\$11.95
25CL-3/16(25 Pieces CL-3/16 Clecos).....\$11.95

SPRING TENSION CLAMPS



These clamps can be applied in a fraction of the time required for ordinary screw clamps by eliminating hand tightening. Provides 70 lbs. of clamping pressure. Uses standard Cleco Pliers.

PART	REACH	CAPACITY	PRICE
24EL	1/2"	0-3/4"	\$2.45
26EL	1"	0-3/4"	\$2.45
542	2"	0-1/2"	\$5.95
543	3"	1/4"-15/32"	\$7.95

CLECO PLIERS



For use with clecos and spring loaded fasteners.

131.....(ATS Brand)\$7.95
131A(Pan American Brand).....\$6.95

SPRING LOADED CLECO PLIERS



These new spring-loaded conventional cleco pliers are designed for a user friendly cleco installation. Made from forged steel, the vertical profile of the Clecall allows for cleco installation in tight areas as well as an upside down surface easily. A tedious task has now become effortless with the Clecall.

12-03756(Upright).....\$20.95
12-03807(Standard).....\$11.95

SHEET METAL FASTENERS

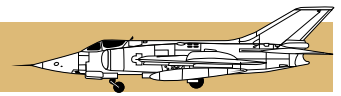

WING NUT FASTENERS



For applications requiring a high-clamping force. These fasteners can be adjusted to deliver from zero to 300 lbs. Perfect for all types of metallic and composite materials.

PART	SIZE	GRIP	PRICE
KWN-3/32	3/32"	0 -1/2"	\$4.95
KWN-1/8	1/8"	0 -1/2"	\$4.95
KWN-5/32	5/32"	0 -1/2"	\$4.95
KWN-3/16	3/16"	0 -1/2"	\$4.95
KWN-7/32	7/32"	0 -1/2"	\$5.95
KWN-1/4	1/4"	0 -1/2"	\$5.95

EXTRA LONG SERIES

KWNL-3/32	3/32"	0 -1"	\$4.95
KWNL-1/8	1/8"	0 -1"	\$4.95
KWNL-5/32	5/32"	0 -1"	\$4.95
KWNL-3/16	3/16"	0 -1"	\$4.95

AIRLOC® GROMMET INSTALLATION TOOLS



FLUSH

ROUND (OVAL)

Airloc® (also branded as A-SPEC™ and ALOC™) fasteners are very common to BeechCraft airplanes and Piper cowlings. This specialty tool is required to flare the stud grommets when installing these type of fasteners. Select the tool corresponding to the series (2 or 5) and style head (flush or round).

PART	DESCRIPTION	PRICE
MS-AL2R	#2 Round (Oval) Head	\$29.95
MS-AL2F	#2 Flush Head	\$29.95
MS-AL5R	#5 Round (Oval) Head	\$29.95
MS-AL5F	#5 Flush Head	\$29.95

HEX NUT FASTENERS



They provide high clamping force with the ability to be quickly installed and removed with a Hex Nut Runner. Delivers from zero to 300 lbs. of clamping force.

PART	SERIES	HEAD	PRICE
HNX-3/32	3/32"	0 -1/2"	\$3.95
HNX-1/8	1/8"	0 -1/2"	\$3.95
HNX-5/32	5/32"	0 -1/2"	\$3.95
HNX-3/16	3/16"	0 -1/2"	\$3.95
HNX-7/32	7/32"	0 -1/2"	\$3.95
HNX-1/4	1/4"	0 -1/2"	\$3.95

EXTRA LONG SERIES

HNXL-3/32	3/32"	0 -1"	\$4.25
HNXL-1/8	1/8"	0 -1"	\$4.25
HNXL-5/32	5/32"	0 -1"	\$4.25
HNXL-3/16	3/16"	0 -1"	\$4.25

AIRLOC CROSSPIN INSTALLATION TOOL



This tool accommodates the two series (diameters) of Airloc (A-Spec) studs commonly found in Beechcraft and Raytheon aircraft: #2 and #5. It has a seat for each series so the cross pin can be installed and centered and operates by placing the pin into the appropriate hole where it should remain seated. Then compress the pliers to force the cross pin into the stud. Once completely clamped, the pin will be perfectly centered in the stud.

MS-ALP \$49.95

WING NUT/HEX NUT DRIVE ADAPTER



Works with any drill chuck, or any 1/4" hex screwdriver. Drives all styles of wing nuts and hex nuts with a 5/16" nut.

MJ350 (USA Made) \$25.95
WHD01 (Economy) \$12.95
MJ375 (Hand Driver) \$25.95

CAMLOC® DRILLING TEMPLATES



MS-DT2



MS-DT4



MS-DT4B

Provides proper hole spacing for Camloc receptacles.

MS-DT2 (2600/2700 series) \$3.95
MS-DT4 (4000 series) \$3.95
MS-DT4B (4000 series hole enlarger) \$3.95

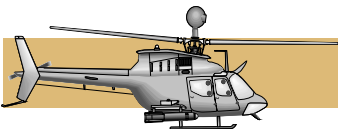

SHEET METAL FASTENERS

DZUS® GROMMET FLARING TOOLS



These tools are designed to flare the stud grommet when installing Dzus® (Z-SPEC and ZLOC™) fasteners. The #5 tool has been specifically designed to replace grommets in Beech Bonanza cowlings without having to remove the cowling brackets. Complete instructions and diagrams included.

Note: Every installation set requires the use of a clamping tool (not included). However you need only one, as each set will fit the same clamp.

PART	SET DESCRIPTION	PRICE
MS-A3C	#3 Round (Oval) Head	\$40.95
MS-A4C	#4 Round (Oval) Head	\$40.95
MS-A5C	#5 Round (Oval) Head	\$40.95
MS-A6.5C	#6.5 Round(Oval) Head	\$40.95
MS-F4C	#4 Flush Head	\$40.95
MS-F5C	#5 Flush Head	\$40.95
MS-F6.5C	#6.5 Flush Head	\$40.95
MS-ZC	Clamping Tool: required for use of the above sets	\$24.95

DZUS® "S" WIRE BENDING JIG



This tool bends Dzus® (Z-Lock) "S" wire receptacles quick and easy. Adjust more than 1/2" by pulling on the spring. Special legs eliminates the risk of pull through. Fits all 5 and 6 series springs. Complete instructions included.

MS-7301 \$41.95

ATS CAMLOC® PLIERS



Used to depress Camloc® studs so they can be properly installed. Manufactured from drop forged steel with polished surfaces. Grips are rubber cushioned for extra comfort and to reduce slipping.

CLP1 \$18.95

CAMLOC® RECEPTACLE DRILL JIG



This drill Jig provides the proper hole spacing for Camloc® (C-Lock) fasteners so that rivet and center holes are drilled accurately and easily. One end of the T16 jig has 3/4" spacing for the 2600 and 2700 series fasteners. The other end has 1" spacing for the 4000 series fasteners.

MS-T16 \$36.95

CAMLOC® GROMMET FLARING TOOL



Used for installing the flare type Camloc (C-Spec) grommets. This simple tool consists of two blocks that are precision machined with the correct contours to make a perfect flare every time.

MS-40GFT \$29.95

AVERY SNOOPY DZUS DRIVER



This classic tool is a favorite of A&P mechanics. It installs and removes the Dzus fasteners typically found in airplane and race car panels.

AE7810 \$19.95

SHEET METAL FASTENERS

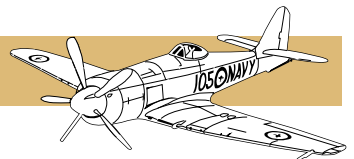

CAMLOC® RECEPTACLE PICK



Used to disengage the locking-clip on the MS213 and MS245 Adjustable-Depth Camloc Receptacles, for depth-setting adjustments.

MS-PK \$7.95

CAMLOC DEPTH TOOL



This tool is pre-set to the receptacle height, which saves time by eliminating the need to put the outer panel in place for fitting, and allows you to go directly to the final installation phase.

MS-ARDT4 (2000 Series) \$62.95

MS-ARDT2 (4000 Series) \$62.95

CAMLOC OVERSIZE RETAINER TOOL



If the installation hole of your Camloc/C-Spec (MS4002 series) is worn out, you must use an oversized hole and retainer. This tool will simplify the process of installing such retainers. It will properly install the retainer on the grommet without disruption the internal teeth of the ring itself.

MS-T40 \$28.95

CAMLOC FLUSH GROMMET COUNTERSINK BIT



Counter Sink Bit for 4000 Series Flush Grommets. When outer panels are too thick for dimpling, use this bit to form the perfect countersinking angle to match Camloc/C-Spec 4000 series flush grommets. Top quality HSS with a detachable center guide.

MS-4GC \$209.95

CAMLOC® SHEET METAL DIMPLING TOOL



MS-27DT

MS-40DT

Used for dimpling thin sheet metal panels to accept Camloc Fasteners. It can also be used to dimple panels to accept FJ4 Series Flush-Head Dzus (Z-Spec) Fasteners.

MS-27DT (2600/2700 Series) \$21.95

MS-40DT (4000 Series) \$21.95

CAMLOC® SNAP RING INSTALLATION TOOLS



Installs Camloc® 2600 and 2700 series fasteners. Quickly installs 2600-LW, 2600-SW and 27S5-1 stud retainers. The rubber tip provides a comfortable grip to prevent fatigue when installing large quantities.

MS-T98 (2600/2700 Series) \$28.95

MS-T26 (4000 Series) \$24.95

DZUS® FLUSH HEAD STUD DIMPLER



This tool dimples sheet metal panels with the exact countersink angle for Dzus® (Z-Lock) FN and FR series flush head studs. Made from heat treated steel and zinc plated for long life. A grade 8 bolt and nut complete the assembly. Fits 5, 6, and 6.5 series.

MS-DT1 \$20.95



HI-LOK® TOOLING

HI-LOK REMOVAL PLIERS



The diamond cut jaws of these Hi-Lok® Removal Pliers will grip the fastener from the top or bottom of the offset head.

3579.....\$39.95

HI-LOK INSTALLATION WRENCH



These clutch driven installation wrenches are designed for smooth, positive engagement in limited access areas. There's no lost motion when you ratchet assemblies. Tested to 220 inch pounds.

PART	DESCRIPTION	DRIVE	PRICE
3539	3/8" dia by 3" long	1/4"	\$62.95
3539L	3/8" dia by 6" long	1/4"	\$69.95

ROLLER-CLUTCH HI-LOK® INSTALLATION WRENCH



Designed for installing Frangible Collar (Hi-Lok®) fasteners in limited access areas. Toothless bearing clutch provides smooth precise movement with no lost motion. Thru-hole permits the use of allen wrench when installing non-interference fit fasteners. Reversible.

PART	DESCRIPTION	DRIVE	PRICE
BT2303	3" long	1/4"	\$45.95
BT2606	6" long	1/4"	\$45.95

HI-LOK® GRIP GAUGE



A convenient tool to determine the correct length and diameter Hi-Lok to use. Just hook it in the hole and read the scale. Graduated in inches on one side, and millimeters on the other.

2-612.....\$9.95

THE "LIBERATOR" HI-LOK INSTALLATION SYSTEM

The 13 piece kit contains two "roller clutch" ratchet heads which are torque rated up to 80 in-lbs; two 1/4" drive studs for use with any brand of 1/4" drive socket, as well as a variety of straight and 90 degree handles. The entire system is interchangeable and will lock into an *unlimited* range of straight and offset configurations! The ratchet heads feature the unique ability to be "indexed" in any position by a full 360 degrees. Includes molded plastic case.



LIBK-13\$115.95

HI-LOK OFFSET PLIERS

The Hi-Lok® Removal Pliers offer a quick and inexpensive alternative for removing any frangible hex collars such as Hi-Lok, Hi-Lite, Hi-Tigue, Veri-Lite and C-Lok fasteners. The hardened steel jaws are specially designed to maximize the gripping surface around the collar.



ZHP-200B\$69.95

ZHP-100B\$52.95

HI-LOK HEX DRIVERS



Use these drivers to "keep" Hi-Lok type fasteners when installing with hand wrenches. Hex tip can be replaced as needed. Comes complete with tip and installation wrench.

HLK-5/64(5/64").....\$6.95

HLK-3/32(3/32").....\$6.95

HLK-1/8(1/8").....\$6.95

HI-LOK REMOVAL SOCKETS

These patented sockets are the ultimate for removing stubborn Hi-Lok® fasteners. Hardened chromium-alloy left-handed taper threads bite into and firmly grips the fastener for easy removal.



PART	HI-LOK SIZE	DRIVE	LENGTH	PRICE
3581-5	5/32"	1/4"	1"	\$23.95
3581-6	3/16"	1/4"	1.21"	\$23.95
3581-8	1/4"	1/4"	1.21"	\$23.95
3581-10	5/16"	1/4"	1.75"	\$24.95
3581-12	3/8"	1/4"	1.75"	\$24.95
3581-14	7/32"	1/4"	1.75"	\$25.95

CUTTERS

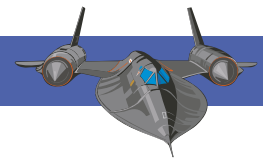

MICROSTOP COUNTERSINK KIT



Our countersink fits any air or electric drill with a 1/4" chuck, and will accept any cutter having a male 1/4-28 thread and a diameter of up to 1/2". Complete kit is a great package deal featuring our 133 Microstop Countersink plus 4 pilot cutters (1000-100 series) in sizes #40, #30, #21, and #12.

- 133KIT(Complete Kit).....\$51.95
- 133.....(Countersink Only)\$27.95
- 133F.....(No-Mar Screw on Foot)\$6.95

HEAVY DUTY MICROSTOP COUNTERSINK



Our heavy duty microstop uses ball bearings for ultra smooth operation. The ball bearing design also makes it run much cooler than a standard microstop. Depth adjustable in 0.001" increments with positive locking collar. Shaft travel is 9/32". Attaches to any drill having a 1/4" chuck. Uses standard 1/4-28 threaded cutters up to 1/2" in diameter. Rated at 10,000 RPM.

- 133-HD\$39.95

MINI MICROSTOP COUNTERSINK



Use this microstop in those tight areas that can't be reached by a standard cage. It's only 1-3/8" long, and threads onto any drill with a 1/4-28 threaded shaft. Features bronze bearing and the positive locking collar is adjustable in 0.003" increments. Uses 1/4-28 threaded cutters up to 5/8" diameter. Shaft travel is 3/32". Rated at 3000 RPM.

- 133-MINI\$20.95

PILOT CUTTERS

- High Speed Steel
- Precision ground diameter
- 1/4-28 male thread
- 3 cutting flute



PART	PILOT	USE	PRICE
100° - 1/2" DIA (for use in standard microstops)			
1000-100-40	40	3/32" rivet	\$6.95
1000-100-30	30	1/8" rivet	\$6.95
1000-100-21	21	5/32" rivet	\$6.95
1000-100-12	12	3/16" rivet	\$6.95
1000-100-33	33	4 AN Screw	\$11.95
1000-100-28	28	6 AN Screw	\$11.95
1000-100-19	19	8 AN Screw	\$10.95
1000-100-12	12	10 AN Screw	\$6.95
120° - 1/2" DIA (for use in standard microstops)			
1000-120-40	40	3/32" rivet	\$10.95
1000-120-30	30	1/8" rivet	\$10.95
100° - 3/8" DIA (for use in slim microstops)			
1038-100-40	40	3/32" rivet	\$7.95
1038-100-30	30	1/8" rivet	\$7.95
1038-100-21	21	5/32" rivet	\$7.95
1038-100-12	12	3/16" rivet	\$7.95

NARROW EXTENDED MICROSTOP COUNTERSINK



This microstop reaches into very confined areas and the extended reach is great for getting down into narrow channels such as seat tracks. Uses 1/4-28 threaded cutters up to 3/8" diameter. Shaft travel is 1/4". Rated at 3000 RPM. **Note: Requires 3/8" dia. cutters.**

- 133-NX\$41.95

SLIM MICROSTOP COUNTERSINK



Our slim microstop packs all the features of a standard microstop in a slim design that's only 11/16" in diameter. It's ideal for those narrow areas that can't be reached with a standard microstop. This micro-stop features bronze bearings, with a depth adjustable in 0.001" increments with positive locking collar. Shaft travel is 9/32". Attaches to any drill having a 1/4" chuck. Uses standard 1/4-28 threaded cutters up to 1/2" in diameter, Rated at 3000 RPM.

- 133-SLIM\$31.95



CUTTERS

ZERO FLUTE PILOT CUTTER

- High Speed Steel
- 1/2" diameter
- 1/4-28 male thread
- 100° x high-hook flute



The unique "high-hook" design of zero flute countersinks allow them to cut with virtually no chatter. Fits into any standard microstop.

PART	PILOT	USE	PRICE
4100-40	40	3/32" rivet	\$25.95
4100-30	30	1/8" rivet	\$25.95
4100-21	21	5/32" rivet	\$25.95
4100-12	12	3/16" rivet	\$25.95

CARBIDE TIPPED CUTTER

- Solid carbide tip
- 1/2" diameter
- 1/4-28 male thread
- 100° x 2 cutting flutes



These cutters work exceptionally well on highly abrasive materials such as Kevlar® and other "difficult to machine" materials.

PART	PILOT	USE	PRICE
3100-40	40	3/32" rivet	\$35.95
3100-30	30	1/8" rivet	\$35.95
3100-21	21	5/32" rivet	\$35.95
3100-12	12	3/16" rivet	\$35.95

ZERO FLUTE COUNTERSINK

- High Speed Steel
- 100° x high-hook flute



The "high-hook" design is a single hole drilled through the head of the cutter, which makes it virtually chatter-free. And since it has no flutes to shift inside the hole, the cutter always stays on center. Fits any drill with a 1/4" chuck.

ZFC01..... (3/32" to 1/4" Diameter)\$10.95
 ZFC02..... (1/8" to 27/64" Diameter)\$13.95

CARBIDE TIPPED CUTTER (REMOVABLE PILOT)

Carbide tipped for durability making it great for composite work. 1/4" x 28 male thread. Requires 1500P pilot. Has 3/32" (0.093) pilot hole. See website for details.



AT455C-1/2 (1/2")\$39.95
 AT455C-5/8 (5/8")\$41.95
 AT455-1/2 (Non-carbide 1/2").....\$19.95

RIVET SHAVER BIT

- Solid carbide tip
- 1/4-28 male thread
- 2 flat cutting flutes



PART	DIAMETER	PRICE
3000-5/16	.313	\$38.95
3000-3/8	.375	\$38.95
3000-7/16	.438	\$38.95
3000-1/2	.500	\$38.95
3000-9/16	.593	\$38.95
3000-5/8	.625	\$38.95

REMOVABLE PILOTS



These pilots are used exclusively with the AT455 Cutters. All pilots have a 3/32" (0.093") shank.

PART	SIZE	PRICE	PART	SIZE	PRICE
1500P-40	40	\$6.95	1500P-16	16	\$6.95
1500P-30	30	\$6.95	1500P-12	12	\$6.95
1500P-27	27	\$6.95	1500P-10	10	\$6.95
1500P-21	21	\$6.95	1500P-3/16	3/16"	\$6.95
1500P-18	18	\$6.95	1500P-1/4	1/4"	\$6.95

CHATTERLESS COUNTERSINK

A unique 6-fluted countersink designed to eliminate the chatter commonly encountered when using conventional countersinks.



408C-4-4..... (1/4"x1/4"x100°).....\$11.95
 408C-4-5..... (5/16"x1/4"x100°).....\$11.95
 408C-4-6..... (3/8"x1/4"x100°).....\$11.95
 408C-4-8..... (1/2"x1/4"x100°).....\$11.95

HOLLOW CUTTER

Hollow cutters are designed to cut away swagged or threaded collars from fasteners so that the fastener pin can be easily removed. Hollow cutters are ideal for removing Hi-Shear® rivets.



493C-5/32..... (5/32")\$7.95
 493C-3/16..... (3/16")\$7.95
 493C-1/4..... (1/4")\$7.95
 493C-5/16..... (5/16")\$7.95
 493C-3/8..... (3/8")\$7.95

CUTTERS

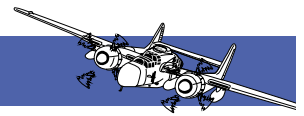

AIRCRAFT COUNTERBORES



Made of High Speed Steel. Requires pilot (see chart below).

PART	DIA.	LENGTH	PILOT SHANK	PRICE
4000-1016	1/4"	2-3/8"	3/32"	\$19.95
4000-1018	9/32"	2-3/8"	3/32"	\$19.95
4000-1020	5/16"	2-3/8"	3/32"	\$19.95
4000-1022	11/32"	2-3/8"	3/32"	\$22.95
4000-1024	3/8"	2-3/8"	3/32"	\$21.95
4000-1026	13/32"	2-3/4"	1/8"	\$22.95
4000-1028	7/16"	2-3/4"	1/8"	\$22.95
4000-1030	15/32"	2-3/4"	1/8"	\$24.95
4000-1032	1/2"	2-3/4"	1/8"	\$24.95
4000-1034	17/32"	2-3/4"	1/8"	\$29.95
4000-1036	9/16"	2-3/4"	1/8"	\$32.95
4000-1038	19/32"	2-3/4"	1/8"	\$30.95
4000-1040	5/8"	2-3/4"	1/8"	\$27.95
4000-1042	21/32"	2-3/4"	3/16"	\$33.95
4000-1044	11/16"	2-3/4"	3/16"	\$39.95

COUNTERBORE PILOTS

For use with 4000 series counterbores (above.)



PART	PILOT	SHANK	PRICE
1400P-1A	3/32"	3/32"	\$5.95
1400P-2A	40	3/32"	\$5.95
1400P-3A	1/8"	3/32"	\$5.95
1400P-3B	1/8"	1/8"	\$5.95
1400P-4A	30	3/32"	\$5.95
1400P-4B	30	1/8"	\$5.95
1400P-5A	5/32"	3/32"	\$5.95
1400P-5B	5/32"	1/8"	\$5.95
1400P-6A	21	3/32"	\$5.95
1400P-6B	21	1/8"	\$5.95
1400P-7A	3/16"	3/32"	\$5.95
1400P-7B	3/16"	1/8"	\$5.95
1400P-8A	10	3/32"	\$5.95
1400P-8B	10	1/8"	\$5.95
1400P-9A	7/32"	3/32"	\$4.95
1400P-9B	7/32"	1/8"	\$4.95
1400P-10A	1/4"	3/32"	\$5.95
1400P-10B	1/4"	1/8"	\$5.95
1400P-11B	9/32"	1/8"	\$5.95
1400P-11C	9/32"	3/16"	\$4.95
1400P-12B	5/16"	1/8"	\$5.95
1400P-12C	5/16"	3/16"	\$4.95
1400P-13B	3/8"	1/8"	\$5.95
1400P-13C	3/8"	3/16"	\$4.95
1400P-14B	13/32"	1/8"	\$4.95
1400P-14C	13/32"	3/16"	\$4.95
1400P-15B	7/16"	1/8"	\$5.95
1400P-15C	7/16"	3/16"	\$4.95
1400P-16B	15/32"	1/8"	\$4.95
1400P-16C	15/32"	3/16"	\$4.95
1400P-17C	1/2"	3/16"	\$4.95

BAYONET SPOTFACE AND COUNTERSINK CUTTERS



AT402 Series (100°)

AT403 Series (Flat)

Made of High Speed Steel. Requires pilot (see chart below).

PART		CUTTER DIA.	PILOT SIZE	PRICE
100°	FLAT			
AT402-1	AT403-1	1/4"	3/32"	\$18.95
AT402-1B	AT403-1B	1/4"	1/8"	\$22.95
AT402-2	AT403-2	5/16"	1/8"	\$19.95
AT402-2B	AT403-2B	5/16"	5/32"	\$23.95
AT402-3	AT403-3	3/8"	1/8"	\$19.95
AT402-3B	AT403-3B	3/8"	5/32"	\$23.95
AT402-3C	AT403-3C	3/8"	3/16"	\$23.95
AT402-4	AT403-4	7/16"	5/32"	\$19.95
AT402-4B	AT403-4B	7/16"	3/16"	\$23.95
AT402-5	AT403-5	1/2"	3/16"	\$24.95
AT402-5B	AT403-5B	1/2"	1/4"	\$24.95
AT402-6	AT403-6	9/16"	3/16"	\$23.95
AT402-6B	AT403-6B	9/16"	1/4"	\$25.95
AT402-7	AT403-7	5/8"	1/4"	\$20.95
AT402-7B	AT403-7B	5/8"	5/16"	\$23.95
AT402-8	AT403-8	3/4"	1/4"	\$41.95
AT402-8B	AT403-8B	3/4"	5/16"	\$32.95
AT402-9	AT403-9	7/8"	3/8"	\$31.95
AT402-10	AT403-10	1"	3/8"	\$56.95

BACK CUTTER PILOTS



For use with AT402 and AT403 series cutters (above).

PART	SIZE	PRICE	PART	SIZE	PRICE
AT404-3/32	3/32"	\$9.95	AT404-1/4	1/4"	\$9.95
AT404-1/8	1/8"	\$9.95	AT404-5/16	5/16"	\$9.95
AT404-5/32	5/32"	\$9.95	AT404-3/8	3/8"	\$9.95
AT404-3/16	3/16"	\$9.95			

100° COUNTERSINKS

Three flute design. Made of High Speed Steel.



PART	DIA.	SHANK	PRICE
2000-1/4X3/16	.250	3/16"	\$12.95
2000-3/8X1/4	.375	1/4"	\$13.95
2000-1/2X3/8	.500	3/8"	\$11.95
2000-5/8X3/8	.625	3/8"	\$14.95
2000-3/4X3/8	.725	3/8"	\$33.95



DRILLING EQUIPMENT

ATS PRO PALM DRILL



KEYLESS CHUCK



PRECISION CHUCK

Our new Pro Palm Drill is only 7" long yet has all of the features of a full sized drill. It delivers up to .5HP of power, and the trigger is fully feathered allowing for very precise speed control. It runs smoothly and quietly even when operating at top speed.

ATS61100.....	(2600 RPM).....	\$129.95
ATS61100K.....	(2600 RPM With Keyless Chuck)	\$149.95
ATS61100P.....	(2600 RPM With Precision Chuck).....	\$169.95
ATS61101.....	(4000 RPM).....	\$139.95
ATS61101K.....	(4000 RPM With Keyless Chuck)	\$164.95
ATS61101P.....	(4000 RPM With Precision Chuck).....	\$175.95

ATS PRO REVERSIBLE PALM DRILL

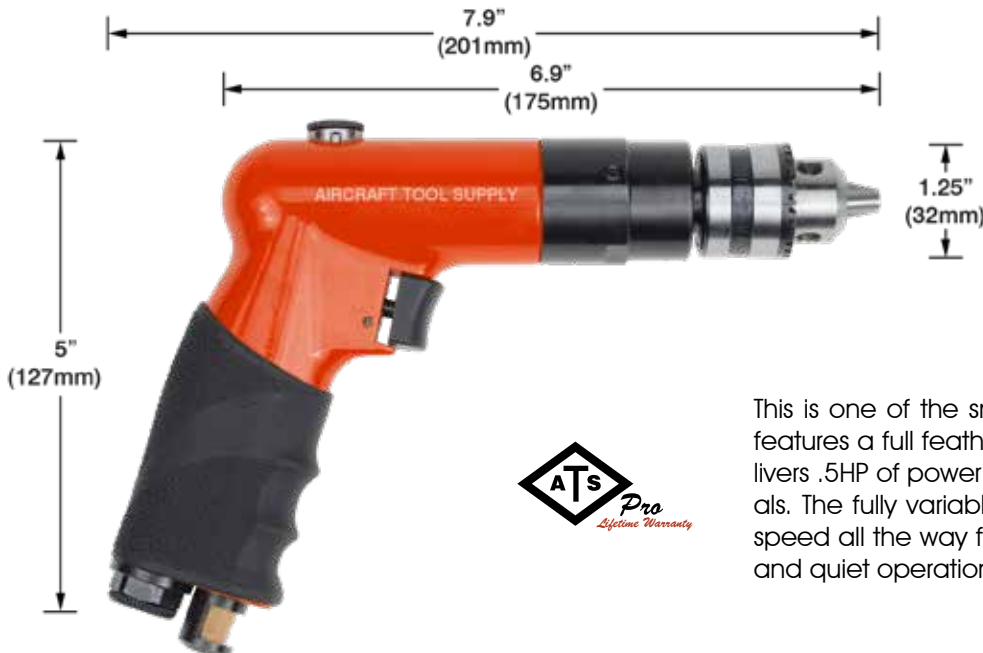

- 1/2HP at operating speed
- 90 psi operating pressure
- Positive reverse mechanism
- 1/4" Jacobs Chuck
- True variable speed trigger
- Rubber grip handle

This is one of the smallest reversible drill on the market that features a full feathering trigger. It's just over 7" long and delivers .5HP of power to drill through even the toughest materials. The fully variable trigger gives you total control over the speed all the way from 0 to 2000 RPM. Very smooth running and quiet operation.

ATS61100R.....	(2000 RPM).....	\$145.95
----------------	-----------------	----------

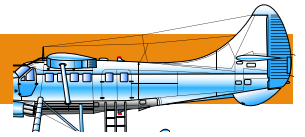

ATS PRO PALM DRILL



ACTUAL SIZE



We now offer a full line of compact Truly Variable speed drills giving you exact control on the job. This quiet design features a feather trigger allowing variable speeds ranging from 500 to 2600 RPM. Our ATS drill is only 7" long yet maintain all the features of a full size drill and only weigh 1.6lbs making it easy to operate without fatigue and consume only 3 cfm at 90 psi. So, whether you're drilling holes or honing these ATS Pro Palm Drills will keep the job moving along. These drills are backed by our **Lifetime Warranty**.





DRILLING EQUIPMENT

ATS HIGH SPEED AVIATION AIR DRILL



- 1/4" (6.4 mm) Jacobs® Chuck
- 2-Speed (Low/High) Control
- Ergonomic design
- 5,000 RPM
- 4.0 CFM
- 1.25 lbs (.5 kg)

A very nice palm-sized precision air drill that runs at 5000 RPM. It's ideal for applications requiring extra-high speed such as drilling fiberglass, composites, or tough metals. It cuts cleanly through aluminum, composites, and even tough metals such as Titanium. Also features planetary gears for smooth operation. 1/4" chuck. Only 6" long. 90 psi pressure.

ATS6100B.....\$119.95

ATS HEAVY DUTY AIR DRILL



- 3/8" (9.5 mm) Jacobs® Chuck
- Variable speed control
- Ergonomic Design
- 7-1/2" (190 mm) OAL
- Full Cage Gear
- 2,600 RPM
- .67 hp (.5 kw)
- 2.07 lbs (.94 kg)

With a speed of 2600 RPM and .67 hp of power, our heavy-duty drill can take on any job. The high quality full cage gear design ensures that this drill keeps running smoothly even under hard abuse. A solid performer that will get the job done every time. 4.0 CFM

ATS6101.....\$85.95

ATS6104.....(2400 RPM Reversible Model)\$85.95

ATS REVERSIBLE PALM DRILL



This palm drill is only 6" long and is fully reversible. Runs smoothly at 2200 RPM thanks to its planetary gear system. Features a comfort grip cushion handle. 1/4" chuck. 90 psi operating pressure. 4.0 CFM

ATS6100F.....\$99.95

ATS PALM DRILL



- 1/4" (6.4 mm) Jacobs® Chuck
- Two-stage (Low/High) Control Trigger
- 5-7/8" (150 mm) Overall Length
- 1.54 lbs (.7 kg)
- 2,800 RPM Free Speed
- 4.0 CFM

This is the drill I wish I had when I was still out there hauling a toolbox. It has everything a proper drill should have: speed, durability, and flexibility. And the nice part is that this feather-light gem is small enough to literally fit into your shirt pocket. A real work of art!

ATS6100.....\$109.95



PRECISION DRILL CHUCK (1/4")



Precision chuck features the utmost in quality. It's a balanced chuck with precision-ground jaws that stays centered to minimize wobble and runout.

T9888-SPC \$49.95

MINIATURE 1/8" DRILL CHUCK



This miniature chuck is a perfect addition to your toolbox. It's less than an inch in diameter and features 1/4-28 thread to mount directly to your Angle Drill or drill attachment. And at only 2 ounces, it will not load down your drill. Excellent for close-quarters work.

T9750-C \$36.95

KEYLESS 1/4" DRILL CHUCK



Positive locking design tightens its grip on the bit as it spins to minimize slippage, but will open with just a simple twist. Jaws closes down to true-zero, so it will handle even the smallest bits while staying on-center.

T9888-KC..... (True-Zero)..... \$34.95

30353..... (Jacobs) \$18.95

CLOSE QUARTER CONE CHUCK



Attaches to all angle drills with 1/4" x 28 thread. Ideal for getting into tight areas.

A604 \$41.95

ATS HEAVY DUTY STRAIGHT AIR DRILL



The in line configuration of a straight drill lets you reach into tight areas and drill without having to worry about your hand or the drill's handle getting in the way.

- 3/8" (9.5 mm) Jacobs® Chuck
- Planetary Gear
- 2,400 RPM
- 7-7/8" (200 mm) Overall Lg.
- .5 hp (.37 kw)
- 2.86 lbs (1.3 kg)

ATS6110..... \$75.95

DRILL STOPS



Used to stop the drill bit after reaching a preset depth. Overall length of 1-5/16"

PART	SIZE	PRICE	P/N	SIZE	PRICE
DS-40	40	\$1.95	DS-21	21	\$1.95
DS-30	30	\$1.95	DS-12	12	\$1.95
DS-1/4	1/4"	\$4.95	DS-5/16	5/16"	\$4.95

DRILL GAUGES

- Top quality drill gauges are used to quickly identify drill sizes.
- Made of heavy-gauge heat treated steel, machined to close tolerances.
- Hole sizes and decimal equivalents are permanently etched into the metal.

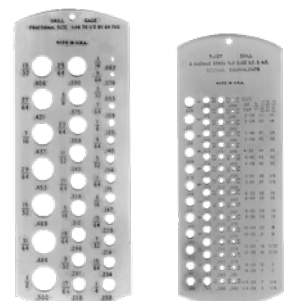

P005

P010

PART	TYPE	HOLES	PRICE
P005	Fractional	29	\$12.95
P010	Number	60	\$12.95



DRILLING EQUIPMENT

ATS COMPACT ANGLE AIR DRILL (WITH JIFFY® HEAD)



With a head height of only .937" (23.8mm) and .625" (15.8mm) in diameter, our Compact Angle Drill will get into those extremely close-quarter areas other drills simply can't. It's solidly engineered with top quality parts such as a Jiffy® angle head, and a powerful compact air motor designed to our specifications. Operates at 3500 RPM and delivers .33 hp using 90 psi of air. Teasing throttle and needle bearing construction for smooth operation and longer tool life. Accepts 1/4-28 threaded drill bits and attachments (1/4" max drill capacity). Overall length of 9". Weighs only 1.08 lbs.

775.....	(90° Drill with Jiffy® Head)	\$449.95
77545.....	(45° Drill with Jiffy® Head)	\$379.95
775A	(90° Drill with Pan American Nova® Head)	\$319.95

ATS ANGLE AIR DRILLS



- Spindle 1/4"-28 Thread
- Head Length 1.08" (27 mm)
- 2,800 RPM
- Head Width .65" (16 mm)
- 33 hp (.25 kw)
- 10" (254 mm) Overall Length
- Variable speed control

This is the drill you need to get into those tight spaces. It has a head height of just over an inch, and produces enough torque at 2800 RPM to drill through steel. Excellent speed control, and has a solid, well-balanced feel.

ATS6131	(45° Angle Drill)	\$259.95
ATS6132.....	(90° Angle Drill).....	\$259.95



90° SNAKE DRILL ATTACHMENT



Our 602 snake attachment consists of the A601 angle drill attachment, a 30" snake cable, and an adapter. The snake is removable to permit the use of the angle drill portion. Drill capacity is 1/4".

602.....\$299.95

90° ANGLE DRILL KIT



One of the most versatile tools on the market today. This kit includes our 602 snake attachment giving you 30" of cable.

Complete kit consists of:

- 1/4-28 Threads
- Tool Case
- 24" Flexible Attachment
- 4 Threaded Drill Bits, 40, 30, 21, 12
- Collet Adapter
- 90° Angle Drill (A601)
- Straight Drill Attachment
- 4 Collets, 40, 30, 21, and 12
- Complete Instructions

6012KT.....\$349.95

90° HEAVY-DUTY SNAKE DRILL ATTACHMENT



Designed with a heavy-duty flexible casing and core assembly for longevity. Fits any air or electric drill. Accepts 1/4" x 28 threaded drill bits and other accessories for close quarter drilling. Dimensions are 30" snake length, 1-1/4" head height, and 3/8" side to center. Drill capacity is 1/4".

N63.....\$235.95

360° HEAVY-DUTY SNAKE DRILL ATTACHMENT



Ideal for drilling in areas inaccessible to regular 90° angle tools. Made of heavy-duty flexible casing and core assembly. Swivels 360° and can be locked into eight different positions. Accepts 1/4" x 28 threaded drill bits and accessories for close quarter drilling. Dimensions are 30" snake length, 1-1/4" head height 1-7/16" offset distance, 3/8" side to center. Drill capacity is 1/4".

N634.....\$460.95

ANGLED DRILL ATTACHMENTS



345



A601

Fits any air or electric drill. Accepts 1/4" x 28 threaded drill bits and other accessories for close quarter drilling. Dimensions are 7-1/2" long, 1-3/16" head height 3/8" side to center. Drill capacity is 1/4".

345..... (45°).....\$209.95

A601..... (90°).....\$125.95

FLAT OFFSET DRILL ATTACHMENT

One of a kind drill attachment. Designed with a head thickness of only 7/16" for drilling in areas as close as 1". Fits any air or electric drill. Accepts 1/4-28 threaded drill bits and accessories for close quarter drilling. Dimensions are 6-5/8" long, 7/16" head thickness, 2-5/16" offset distance, 7/16" side to center. Drill capacity is 1/4".



T235.....\$275.95

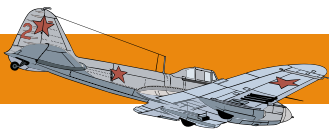

DRILLING EQUIPMENT

BOELUBE®



Boelube® is a specially formulated lubricant patented by Boeing Aerospace. Use it on drill bits, reamers, saw blades, taps and dies, boring tools, and any other application where smooth cutting action is required. The application of a small amount of Boelube, which is consumed in the metalworking process, will greatly improve tool life, surface finish, and hole quality. Recommended for use on aluminum, titanium, inconel, stainless steel,

graphite, composites, Kevlar, and wood. Can also be used with other ferrous and non-ferrous metals.

- BL70200-13(1.6oz Stick)..... \$4.95
- BL90(4oz Liquid)..... \$9.95
- BL70104H(Drill Lube)..... \$10.95
- BL70307L(4oz Paste)..... \$11.95

PROFESSIONAL AUTOMATIC CENTER PUNCH

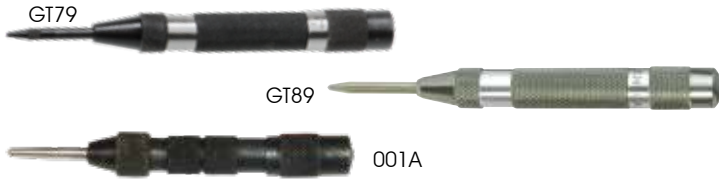

An Automatic Center Punch is the standard in automatic center punches. It is tough enough to mark hard metals, yet not overbearing when working with aluminum skin, or thin-walled tubing. Replaceable steel point available.

- GT79(Professional)..... \$27.95
- GT79P(Replacement Point)..... \$3.95
- GT89(Stainless Steel)..... \$15.95
- 001A(Economy)..... \$8.95

NOXON® HAMMERLESS PUNCH



It's a brilliant idea: connect a prick punch and a center punch to each end of a powerful

spring to produce the ultimate punch. Just place the working end on any surface, pull the striking end straight back and release. The prick punch marks lightly, while the center punch creates a deeper indentation for drill starts.

- 32R00-1 \$12.95

DIAMOND DUST PLASTIC DRILL BIT



Diamond Dust Coated plastic drill bits provide superior cutting action in Plexiglas, polycarbonates, and acrylics. They have a 60 degree point and a 0 degree rake that prevents the drill from walking or "breaking out" as with ordinary drill bits. They will not chip, crack, or gum up the material. Use to drill stacks or singles, with or without masking. Ideal for drilling mounting holes, or crack stopping holes in windshields and canopies.

- DDPD-1/8(1/8")..... \$3.05
- DDPD-3/16(3/16")..... \$3.95
- DDPD-1/4(1/4")..... \$3.95

PLEXIGLAS DRILL BITS



Made of high-speed steel. 90° point, 0° rake. Jobbers length. Slow spiral makes it ideal for drilling Plexiglas, acrylic, and polycarbonate.

PART	DIAMETER	DEC.	FLUTE	PRICE
AC55-1/8	1/8"	0.1250	1-5/8"	\$3.95
AC55-5/32	5/32"	0.1562	2"	\$4.95
AC55-3/16	3/16"	0.1875	2-5/16"	\$4.95
AC55-1/4	1/4"	0.2500	2-3/4"	\$4.95
AC55-5/16	5/16"	0.3125	3-1/8"	\$6.95
AC55-3/8	3/8"	0.3750	3-5/8"	\$8.95
AC55-7/16	7/16"	0.4375	4-1/16"	\$12.95
AC55-1/2	1/2"	0.5000	4-1/2"	\$15.95

AIRCRAFT TAPERED ROUTER BITS



Used for cutting, trimming and routing. 1/4" per foot taper.

PART	SHANK DIAMETER (IN.)	LENGTH	PRICE
910-1	.081-.098	2"	\$4.95
910-2	.110-.128	2-1/4"	\$5.95
910-3	.165-.1875	2-1/2"	\$7.95
910-4	.224-.250	2-3/4"	\$9.95

PLASTIC EDGE SCRAPER



This unique tool has four features in one. Not only will it remove saw marks from flat edges, it also bevels thick and thin material, and will radius the edge quickly and evenly.

- CE501 \$11.95



Cobalt Drill Bits

ATS now carries a full selection in jobber, threaded, and aircraft lengths.

Surface Finish

Color tempered finish enables easy identification of cobalt drills.

135° Split Point

Enables accurate positioning and less drilling pressure.

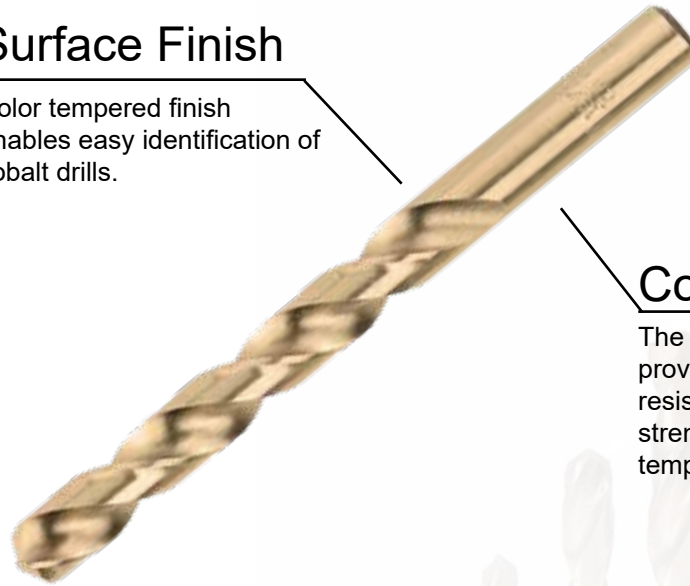

Cobalt Alloyed

The cobalt formula improves abrasive and heat resistance, for increased strength at higher drilling temperatures.

What everyone has been waiting for! You know the story, you purchase a drill bit and then discover you should have bought a few more. Save yourself the time and money and buy cobalt drill bits in packs of six or twelve bits. Volume discounts are available as well. This addition to our product line is surely one you will want to take advantage of.

Visit www.aircraft-tool.com for our full line of drill bits.

E-mail quotes@aircraft-tool.com for special pricing

COBALT DRILL INDEX



These drill bits are made from cobalt steel for increased durability. Standard 135-degree chisel point is recommended for stationary drilling applications and they're ideal for drilling in tough materials like stainless steel, titanium, and inconel. The set comes in a metal index case for convenient storage and transportation. All sizes are straight shank.

- 012-C60N (#1-60 Wire Size)..... **\$89.95**
- 012-C29F (1/16-1/2" Fractional) **\$95.95**
- 012-C26A.....(A-Z Letter Sizes) **\$95.95**

115 PIECE COBALT DRILL INDEX



Each of these 115 cobalt drill bits comes organized in a metal indexed storage case for easy transport to your work site. With aggressive 135 degree tips, these cobalt drills bits not only last longer but also cut faster than your standard high speed steel bits! This set contains numbered bits: 1-60, lettered bits A-Z, and fractional bits 1/16-1/2 by 64ths. All bits are cobalt jobber length drill bits.

- 012-C115..... (Complete Set) **\$275.95**





DRILLING EQUIPMENT

COBALT JOBBER LENGTH BITS



Cobalt jobber drill bits are used for drilling in tough materials like Stainless steel, Titanium, and Inconel. They are made to NAS907 Type J specifications and have a 135° split point flute. Bright finish.

PART	SIZE	DEC	PRICE	PART	SIZE	DEC	PRICE	PART	SIZE	DEC	PRICE
012-55	55	.0520	\$1.25	012-21	21	.1590	\$1.85	012-M	M	.2950	\$4.95
012-54	54	.0550	\$1.25	012-20	20	.1610	\$1.85	012-19/64	19/64	.2969	\$3.95
012-53	53	.0595	\$1.25	012-19	19	.1660	\$2.05	012-N	N	.3020	\$4.95
012-1/16	1/16	.0625	\$1.25	012-18	18	.1695	\$2.05	012-5/16	5/16	.3125	\$4.95
012-52	52	.0635	\$1.25	012-11/64	11/64	.1719	\$1.85	012-O	O	.3160	\$4.95
012-51	51	.0670	\$1.25	012-17	17	.1730	\$2.05	012-P	P	.3230	\$4.95
012-50	50	.0700	\$1.25	012-16	16	.1770	\$2.25	012-21/64	21/64	.3281	\$4.95
012-49	49	.0730	\$1.25	012-15	15	.1800	\$2.25	012-Q	Q	.3320	\$4.95
012-48	48	.0760	\$1.25	012-14	14	.1820	\$2.25	012-R	R	.3390	\$4.95
012-5/64	5/64	.0781	\$1.25	012-13	13	.1850	\$2.25	012-11/32	11/32	.3438	\$4.95
012-47	47	.0785	\$1.25	012-3/16	3/16	.1875	\$2.05	012-S	S	.3480	\$5.95
012-46	46	.0810	\$1.25	012-12	12	.1890	\$2.25	012-T	T	.3580	\$5.95
012-45	45	.0820	\$1.25	012-11	11	.1910	\$2.25	012-23/64	23/64	.3594	\$5.95
012-44	44	.0860	\$1.25	012-10	10	.1935	\$2.05	012-U	U	.3680	\$5.95
012-43	43	.0890	\$1.25	012-9	9	.1960	\$2.25	012-3/8	3/8	.3750	\$5.95
012-42	42	.0935	\$1.25	012-8	8	.1990	\$2.25	012-V	V	.3770	\$6.95
012-3/32	3/32	.0938	\$1.25	012-7	7	.2010	\$2.25	012-W	W	.3860	\$6.95
012-41	41	.0960	\$1.35	012-13/64	13/64	.2031	\$2.25	012-25/64	25/64	.3906	\$6.95
012-40	40	.0980	\$1.35	012-6	6	.2040	\$2.55	012-X	X	.3970	\$7.95
012-39	39	.0995	\$1.35	012-5	5	.2055	\$2.55	012-Y	Y	.4040	\$7.95
012-38	38	.1015	\$1.35	012-4	4	.2090	\$2.55	012-13/32	13/32	.4063	\$6.95
012-37	37	.1040	\$1.55	012-3	3	.2130	\$2.55	012-Z	Z	.4130	\$7.95
012-36	36	.1065	\$1.55	012-7/32	7/32	.2188	\$2.25	012-27/64	27/64	.4219	\$7.00
012-7/64	7/64	.1094	\$1.55	012-2	2	.2210	\$2.55	012-7/16	7/16	.4375	\$7.95
012-35	35	.1100	\$1.55	012-1	1	.2280	\$2.55	012-29/64	29/64	.4531	\$8.95
012-34	34	.1110	\$1.55	012-A	A	.2340	\$2.85	012-15/32	15/32	.4688	\$8.95
012-33	33	.1130	\$1.55	012-15/64	15/64	.2344	\$2.55	012-31/64	31/64	.4844	\$8.95
012-32	32	.1160	\$1.25	012-B	B	.2380	\$3.05	012-1/2	1/2	.5000	\$9.95
012-31	31	.1200	\$1.25	012-C	C	.2420	\$3.05				
012-1/8	1/8	.1250	\$1.55	012-D	D	.2460	\$3.05				
012-30	30	.1285	\$1.25	012-1/4	1/4	.2500	\$2.85				
012-29	29	.1360	\$1.85	012-E	E	.2500	\$2.85				
012-28	28	.1405	\$1.85	012-F	F	.2570	\$3.95				
012-9/64	9/64	.1406	\$1.55	012-G	G	.2610	\$3.95				
012-27	27	.1440	\$1.85	012-17/64	17/64	.2656	\$3.95				
012-26	26	.1470	\$1.85	012-H	H	.2660	\$3.95				
012-25	25	.1495	\$1.85	012-I	I	.2720	\$3.95				
012-24	24	.1520	\$2.05	012-J	J	.2770	\$3.95				
012-23	23	.1540	\$2.05	012-K	K	.2810	\$3.95				
012-5/32	5/32	.1563	\$1.85	012-9/32	9/32	.2813	\$3.95				
012-22	22	.1570	\$2.05	012-L	L	.2900	\$3.95				

COBALT DRILL PACKS



Buy
in 6 and
12 packs
to save up to
40%

Visit www.aircraft-tool.com
to see full selection.



6" AIRCRAFT EXTENSION DRILL BITS



Aircraft extension drill bits are designed to resist bending and buckling under torsional loads, which makes them perfect for unsupported drilling into deep areas. They are manufactured to NAS 907 Type B and type J specifications. Great for drilling aluminum and mild steel. Constructed of M-2 high speed steel for the best combination of strength, heat resistance, and wear resistance. Black oxide coating resists corrosion. 135 degree split point ensures a true start and eliminates bit walking.

PART	SIZE	DEC	PRICE	PART	SIZE	DEC	PRICE	PART	SIZE	DEC	PRICE
013-55	55	.0520	\$4.95	013-24	24	.1520	\$3.95	013-G	G	.2610	\$8.95
013-54	54	.0550	\$4.95	013-23	23	.1540	\$3.95	013-17/64	17/64	.2656	\$6.95
013-53	53	.0595	\$4.95	013-5/32	5/32	.1563	\$3.95	013-H	H	.2660	\$7.95
013-1/16	1/16	.0625	\$3.05	013-22	22	.1570	\$3.95	013-I	I	.2720	\$8.95
013-52	52	.0635	\$3.05	013-21	21	.1590	\$3.95	013-J	J	.2770	\$8.95
013-51	51	.0670	\$3.05	013-20	20	.1610	\$3.95	013-K	K	.2810	\$8.95
013-50	50	.0700	\$3.05	013-19	19	.1660	\$3.95	013-9/32	9/32	.2813	\$7.95
013-49	49	.0730	\$3.05	013-18	18	.1695	\$3.95	013-L	L	.2900	\$9.95
013-48	48	.0760	\$3.05	013-11/64	11/64	.1719	\$3.95	013-M	M	.2950	\$9.95
013-5/64	5/64	.0781	\$3.05	013-17	17	.1730	\$3.95	013-19/64	19/64	.2969	\$8.95
013-47	47	.0785	\$3.05	013-16	16	.1770	\$3.95	013-N	N	.3020	\$10.95
013-46	46	.0810	\$3.05	013-15	15	.1800	\$3.95	013-5/16	5/16	.3125	\$7.95
013-45	45	.0820	\$3.05	013-14	14	.1820	\$3.95	013-O	O	.3160	\$11.95
013-44	44	.0860	\$3.05	013-13	13	.1850	\$3.95	013-P	P	.3230	\$11.95
013-43	43	.0890	\$3.05	013-3/16	3/16	.1875	\$3.95	013-21/64	21/64	.3281	\$9.95
013-42	42	.0935	\$3.05	013-12	12	.1890	\$3.95	013-Q	Q	.3320	\$11.95
013-3/32	3/32	.0938	\$2.95	013-11	11	.1910	\$3.95	013-R	R	.3390	\$11.95
013-41	41	.0960	\$3.05	013-10	10	.1935	\$3.95	013-11/32	11/32	.3438	\$9.95
013-40	40	.0980	\$3.05	013-9	9	.1960	\$3.95	013-S	S	.3480	\$12.95
013-39	39	.0995	\$3.05	013-8	8	.1990	\$3.95	013-T	T	.3580	\$12.95
013-38	38	.1015	\$3.05	013-7	7	.2010	\$3.95	013-23/64	23/64	.3594	\$9.95
013-37	37	.1040	\$3.05	013-13/64	13/64	.2031	\$3.95	013-U	U	.3680	\$12.95
013-36	36	.1065	\$3.05	013-6	6	.2040	\$3.95	013-3/8	3/8	.3750	\$11.95
013-7/64	7/64	.1094	\$3.95	013-5	5	.2055	\$3.95	013-V	V	.3770	\$13.95
013-35	35	.1100	\$2.95	013-4	4	.2090	\$3.95	013-W	W	.3860	\$12.95
013-34	34	.1110	\$3.05	013-3	3	.2130	\$3.95	013-25/64	25/64	.3906	\$13.95
013-33	33	.1130	\$3.05	013-7/32	7/32	.2188	\$3.95	013-X	X	.3970	\$10.95
013-32	32	.1160	\$3.05	013-2	2	.2210	\$3.95	013-Y	Y	.4040	\$13.95
013-31	31	.1200	\$3.05	013-1	1	.2280	\$3.95	013-13/32	13/32	.4063	\$10.95
013-1/8	1/8	.1250	\$3.95	013-A	A	.2340	\$4.95	013-Z	Z	.4130	\$14.95
013-30	30	.1285	\$3.95	013-15/64	15/64	.2344	\$4.95	013-27/64	27/64	.4219	\$9.95
013-29	29	.1360	\$3.95	013-B	B	.2380	\$4.95	013-7/16	7/16	.4375	\$11.95
013-28	28	.1405	\$3.95	013-C	C	.2420	\$4.95	013-29/64	29/64	.4531	\$13.95
013-9/64	9/64	.1406	\$3.95	013-D	D	.2460	\$4.95	013-15/32	15/32	.4688	\$14.95
013-27	27	.1440	\$3.95	013-1/4	1/4	.2500	\$4.95	013-31/64	31/64	.4844	\$14.95
013-26	26	.1470	\$3.95	013-E	E	.2500	\$4.95	013-1/2	1/2	.5000	\$15.95
013-25	25	.1495	\$3.95	013-F	F	.2570	\$5.95				



DRILLING EQUIPMENT

12" AIRCRAFT EXTENSION DRILL BITS



Aircraft extension drill bits are designed to resist bending and buckling under torsional loads, which makes them perfect for unsupported drilling into deep areas. They are manufactured to NAS 907 Type B and type J specifications. Great for drilling aluminum and mild steel. Constructed of M-2 high speed steel for the best combination of strength, heat resistance, and wear resistance. Black oxide coating resists corrosion. 135 degree split point ensures a true start and eliminates bit walking.

PART	SIZE	DEC	PRICE	PART	SIZE	DEC	PRICE	PART	SIZE	DEC	PRICE
014-55	55	.0520	\$8.05	014-24	24	.1520	\$4.95	014-G	G	.2610	\$5.95
014-54	54	.0550	\$8.95	014-23	23	.1540	\$4.95	014-17/64	17/64	.2656	\$8.95
014-53	53	.0595	\$8.95	014-5/32	5/32	.1563	\$3.95	014-H	H	.2660	\$10.95
014-1/16	1/16	.0625	\$5.95	014-22	22	.1570	\$4.95	014-I	I	.2720	\$10.95
014-52	52	.0635	\$8.95	014-21	21	.1590	\$4.95	014-J	J	.2770	\$10.95
014-51	51	.0670	\$8.95	014-20	20	.1610	\$4.95	014-K	K	.2810	\$10.95
014-50	50	.0700	\$3.95	014-19	19	.1660	\$4.95	014-9/32	9/32	.2813	\$8.95
014-49	49	.0730	\$3.95	014-18	18	.1695	\$4.95	014-L	L	.2900	\$10.95
014-48	48	.0760	\$3.95	014-11/64	11/64	.1719	\$3.95	014-M	M	.2950	\$10.95
014-5/64	5/64	.0781	\$3.95	014-17	17	.1730	\$4.95	014-19/64	19/64	.2969	\$8.95
014-47	47	.0785	\$3.95	014-16	16	.1770	\$5.95	014-N	N	.3020	\$11.95
014-46	46	.0810	\$3.95	014-15	15	.1800	\$4.95	014-5/16	5/16	.3125	\$10.95
014-45	45	.0820	\$3.95	014-14	14	.1820	\$4.95	014-O	O	.3160	\$12.95
014-44	44	.0860	\$3.95	014-13	13	.1850	\$5.95	014-P	P	.3230	\$12.95
014-43	43	.0890	\$3.95	014-3/16	3/16	.1875	\$4.95	014-21/64	21/64	.3281	\$10.95
014-42	42	.0935	\$3.95	014-12	12	.1890	\$4.95	014-Q	Q	.3320	\$12.95
014-3/32	3/32	.0938	\$3.95	014-11	11	.1910	\$4.95	014-R	R	.3390	\$13.95
014-41	41	.0960	\$3.95	014-10	10	.1935	\$4.95	014-11/32	11/32	.3438	\$10.95
014-40	40	.0980	\$3.05	014-9	9	.1960	\$5.95	014-S	S	.3480	\$14.95
014-39	39	.0995	\$3.95	014-8	8	.1990	\$4.95	014-T	T	.3580	\$14.95
014-38	38	.1015	\$3.95	014-7	7	.2010	\$4.95	014-23/64	23/64	.3594	\$11.95
014-37	37	.1040	\$3.95	014-13/64	13/64	.2031	\$4.95	014-U	U	.3680	\$14.95
014-36	36	.1065	\$3.95	014-6	6	.2040	\$4.95	014-3/8	3/8	.3750	\$11.95
014-7/64	7/64	.1094	\$4.95	014-5	5	.2055	\$4.95	014-V	V	.3770	\$14.95
014-35	35	.1100	\$3.95	014-4	4	.2090	\$4.95	014-W	W	.3860	\$14.95
014-34	34	.1110	\$3.95	014-3	3	.2130	\$4.95	014-25/64	25/64	.3906	\$12.95
014-33	33	.1130	\$3.95	014-7/32	7/32	.2188	\$4.95	014-X	X	.3970	\$15.95
014-32	32	.1160	\$3.95	014-2	2	.2210	\$4.95	014-Y	Y	.4040	\$15.95
014-31	31	.1200	\$3.95	014-1	1	.2280	\$4.95	014-13/32	13/32	.4063	\$12.95
014-1/8	1/8	.1250	\$3.95	014-A	A	.2340	\$4.95	014-Z	Z	.4130	\$16.95
014-30	30	.1285	\$3.95	014-15/64	15/64	.2344	\$4.95	014-27/64	27/64	.4219	\$14.95
014-29	29	.1360	\$4.95	014-B	B	.2380	\$4.95	014-7/16	7/16	.4375	\$15.95
014-28	28	.1405	\$4.95	014-C	C	.2420	\$4.95	014-29/64	29/64	.4531	\$14.95
014-9/64	9/64	.1406	\$4.95	014-D	D	.2460	\$4.95	014-15/32	15/32	.4688	\$17.95
014-27	27	.1440	\$4.95	014-1/4	1/4	.2500	\$5.95	014-31/64	31/64	.4844	\$17.95
014-26	26	.1470	\$4.95	014-E	E	.2500	\$4.95	014-1/2	1/2	.5000	\$17.95
014-25	25	.1495	\$4.95	014-F	F	.2570	\$5.95				

DRILLING EQUIPMENT



COBALT THREADED DRILL BITS

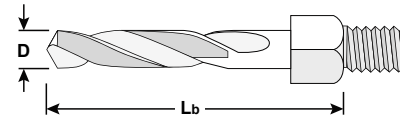

1/4-28 threaded shank. Cobalt-M35 with black oxide finish. 135° Split point. NAS965 Type D standards.

SHORT (Lb = 1-1/4")			
PART	SIZE (D)	DEC	PRICE
5000-3/32	3/32	.0938	\$2.25
5000-40	40	.0980	\$1.95
5000-1/8	1/8	.1250	\$2.25
5000-30	30	.1285	\$1.85
5000-29	29	.1360	\$2.25
5000-27	27	.1440	\$2.25
5000-5/32	5/32	.1563	\$2.35
5000-21	21	.1590	\$1.95
5000-20	20	.1610	\$2.35
5000-19	19	.1660	\$2.35
5000-16	16	.1770	\$2.45
5000-13	13	.1850	\$2.45
5000-3/16	3/16	.1875	\$2.45
5000-12	12	.1890	\$2.05
5000-11	11	.1910	\$2.45
5000-10	10	.1935	\$2.55
5000-7	7	.2010	\$2.55
5000-6	6	.2040	\$2.55
5000-5	5	.2055	\$2.55
5000-1	1	.2280	\$2.55
5000-D	D	.2460	\$2.55
5000-1/4	1/4	.2500	\$3.05

SUPER STUBBY (Lb = 3/8")			
PART	SIZE (D)	DEC	PRICE
5000-40SS	40	.0980	\$3.95
5000-30SS	30	.1285	\$3.95

LONG (Lb = 2-1/8")			
PART	SIZE (D)	DEC	PRICE
5000-3/32L	3/32	.0938	\$2.85
5000-40L*	40	.0980	\$2.25
5000-1/8L	1/8	.1250	\$2.85
5000-30L	30	.1285	\$2.25
5000-29L	29	.1360	\$2.85
5000-27L	27	.1440	\$2.85
5000-5/32L	5/32	.1563	\$2.85
5000-21L*	21	.1590	\$2.85
5000-19L	19	.1660	\$2.85
5000-3/16L	3/16	.1875	\$3.05
5000-12L*	12	.1890	\$2.55
5000-11L	11	.1910	\$3.05
5000-10L*	10	.1935	\$3.05
5000-7/32L	7/32	.2188	\$3.05
5000-1/4L	1/4	.2500	\$3.05

*Replacement bits for our 1341A and 1341S rivet removal tools.

STUBBY (Lb = 5/8")			
PART	SIZE (D)	DEC	PRICE
5000-3/32S	3/32	.0938	\$2.85
5000-40S	40	.0980	\$2.75
5000-30S	30	.1285	\$2.85
5000-29S	29	.1360	\$2.85
5000-27S	27	.1440	\$2.85
5000-5/32S	5/32	.1563	\$2.75
5000-21S	21	.1590	\$2.75
5000-19S	19	.1660	\$2.85
5000-3/16S	3/16	.1875	\$3.05
5000-12S	12	.1890	\$3.05
5000-10S	10	.1935	\$3.05
5000-1/4S	1/4	.2500	\$3.95

EXTRA LONG (Lb = 2-5/8")			
PART	SIZE (D)	DEC	PRICE
5000-1/8XL	1/8	.1250	\$2.55
5000-30XL	30	.1285	\$3.95
5000-21XL	21	.1590	\$3.95
5000-40XL	40	.0980	\$3.95
5000-10XL	10	.1935	\$4.95

THREADED DRILL BITS 4-PACK



Package of four (4) 1/4-28 Threaded Drill Bits in sizes: #40, #30, #21, and #12. Cobalt steel with black oxide finish.

4PCBITS \$6.95



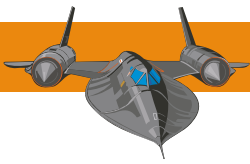

DRILLING EQUIPMENT

CHUCKING REAMERS



High speed steel straight flute chucking reamers are made with a diameter tolerance of: +.0002 -.0000

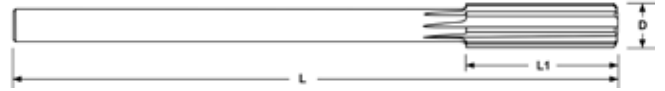

PART	SIZE (D)	DEC	FLUTE (L1)	OAL (L)	PRICE	PART	SIZE (D)	DEC	FLUTE (L1)	OAL (L)	PRICE
RMR-3/32	3/32	.0938	7/8	3-1/2	\$9.95	RMR-9	9	.1960	1-1/4	5	\$10.25
RMR-40	40	.0980	7/8	3-1/2	\$9.95	RMR-8	8	.1990	1-1/4	5	\$10.25
RMR-39	39	.0995	7/8	3-1/2	\$12.95	RMR-7	7	.2010	1-1/4	5	\$10.25
RMR-38	38	.1015	7/8	3-1/2	\$9.95	RMR-13/64	13/64	.2031	1-1/4	5	\$10.95
RMR-37	37	.1040	7/8	3-1/2	\$9.95	RMR-6	6	.2040	1-1/4	5	\$10.25
RMR-36	36	.1065	7/8	3-1/2	\$9.95	RMR-5	5	.2055	1-1/4	5	\$10.95
RMR-7/64	7/64	.1094	7/8	3-1/2	\$9.95	RMR-4	4	.2090	1-1/4	5	\$10.25
RMR-35	35	.1100	7/8	3-1/2	\$9.95	RMR-3	3	.2130	1-1/4	5	\$10.25
RMR-34	34	.1110	7/8	3-1/2	\$9.95	RMR-7/32	7/32	.2188	1-1/4	5	\$10.95
RMR-33	33	.1130	7/8	3-1/2	\$9.95	RMR-2	2	.2210	1-1/4	5	\$10.25
RMR-32	32	.1160	7/8	3-1/2	\$9.95	RMR-1	1	.2280	1-1/2	6	\$10.25
RMR-31	31	.1200	7/8	3-1/2	\$9.95	RMR-15/64	15/64	.2344	1-1/2	6	\$10.25
RMR-1/8	1/8	.1250	7/8	3-1/2	\$9.95	RMR-1/4	1/4	.2500	1-1/2	6	\$11.95
RMR-30	30	.1285	7/8	3-1/2	\$9.95	RMR-9/32	9/32	.2813	1-1/2	6	\$10.25
RMR-29	29	.1360	1	4	\$9.95	RMR-5/16	5/16	.3125	1-1/2	6	\$10.95
RMR-28	28	.1405	1	4	\$9.95	RMR-21/64	21/64	.3281	1-1/2	6	\$10.95
RMR-9/64	9/64	.1406	1	4	\$9.95	RMR-11/32	11/32	.3438	1-1/2	6	\$10.95
RMR-27	27	.1440	1	4	\$9.95	RMR-3/8	3/8	.3750	1-3/4	7	\$10.95
RMR-26	26	.1470	1	4	\$9.95	RMR-27/64	27/64	.4219	1-3/4	7	\$11.50
RMR-25	25	.1495	1	4	\$9.95	RMR-7/16	7/16	.4375	1-3/4	7	\$11.95
RMR-24	24	.1520	1	4	\$9.95	RMR-33/64	33/64	.5156	2	8	\$19.50
RMR-23	23	.1540	1	4	\$9.95	RMR-1/2	1/2	.5000	2	8	\$13.95
RMR-5/32	5/32	.1563	1	4	\$9.95						
RMR-22	22	.1570	1	4	\$9.95						
RMR-21	21	.1590	1-1/8	4-1/2	\$18.95						
RMR-20	20	.1610	1-1/8	4-1/2	\$9.95						
RMR-19	19	.1660	1-1/8	4-1/2	\$9.95						
RMR-18	18	.1695	1-1/8	4-1/2	\$9.95						
RMR-11/64	11/64	.1719	1-1/8	4-1/2	\$9.95						
RMR-17	17	.1730	1-1/8	4-1/2	\$9.95						
RMR-16	16	.1770	1-1/8	4-1/2	\$9.95						
RMR-15	15	.1800	1-1/8	4-1/2	\$9.95						
RMR-14	14	.1820	1-1/8	4-1/2	\$9.95						
RMR-13	13	.1850	1-1/8	4-1/2	\$9.95						
RMR-3/16	3/16	.1875	1-1/8	4-1/2	\$10.95						
RMR-12	12	.1890	1-1/4	5	\$10.95						
RMR-11	11	.1910	1-1/4	5	\$10.25						
RMR-10	10	.1935	1-1/4	5	\$10.95						

COBALT REAMER SET

An indexed set of straight flute cobalt reamers ground to a tolerance of 0.0001 inches. Ideal for sizing holes prior to bolt installation and other application requiring precise hole tolerances. Works with aluminum, steel, and other metals of medium hardness.



RMR-C29F (Fraction Set) \$349.95
 RMR-C60N..... (Number Set) \$549.95

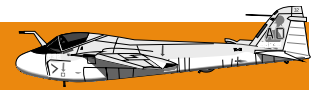

HAND EXPANSION REAMERS



High Speed Straight Flutes. Expansion Limits: +/- 0.006".

PART	DIA (IN.)	# OF FLUTES	FLUTE LEN.	OVERALL LEN (IN.)	PRICE
016AR	1/4	6	1-7/16	3-7/8	\$94.95
020AR	5/16	6	1-3/4	4	\$57.95
024AR	3/8	6	1-3/4	4-1/4	\$57.95
028AR	7/16	6	1-3/4	4-1/2	\$59.95
032AR	1/2	6	1-13/16	5	\$59.95
036AR	9/16	8	2-1/8	5-1/2	\$62.95
040AR	5/8	8	2-1/2	6	\$69.95

TI-COATED STEP DRILL SET



These TiN (Titanium Nitrate) coated stepped drill bit sets make it easy to drill 28 hole sizes. Constructed from high-speed steel, they feature clearly marked hole sizes and have a titanium finish for long bit life. Includes 13-Step bit ranging from 1/8

in. to 1/2 in., 6-Step bit ranging from 3/16 in. to 1/2 in., and a 9-Step bit ranging from 1/4 in. to 3/4 in.

- 16503.....\$16.95
 16504.....(1/4"-3/4" Only).....\$12.95

HAND TAPERED REAMERS



Tapered reamers are great for hole enlarging, or deburring. Cuts steel, brass, aluminum, plastic, and wood.

- GT130(T-Handle).....\$11.95
 GT131(Straight Handle).....\$14.95

PILOTED REAMERS



High Speed Piloted Reamers are ideally suited for cleaning and re-sizing valve guides, Guide Boss, Rocker Arm, and Shaft Bushings; and Rocker Shaft Support Base. They are made of high speed tool steel and precision ground to your exact specifications. You specify size. Available from .3750 thru .5100".

- PRO1.....\$75.95

Note: Please specify reamer size and pilot size when ordering.

BROWN AND SHARPE TAPERED PIN REAMERS



Used to size AN385 and AN386 taper pin holes

PART	DIAMETER OF REAMER		FLUTE LENGTH	O.A.L.	PRICE
	LARGE END	SMALL END			
BSR-1	.3176	.1974	2-7/8"	4-3/4"	\$31.95
BSR-2	.3781	.2474	3-1/8"	5-1/8"	\$39.95
BSR-3	.4510	.3099	3-3/8"	5-1/2"	\$36.95
BSR-4	.5017	.3474	3-11/16"	5-7/8"	\$40.95
BSR-5	.6145	.4474	4"	6-3/8"	\$46.95
BSR-6	.6808	.4974	4-3/8"	6-7/8"	\$51.95
BSR-7	.8011	.5974	4-7/8"	7-1/2"	\$51.95
BSR-8	.9770	.7474	5-1/2"	8-1/8"	\$62.95
BSR-9	1.1530	.8974	6-1/8"	8-7/8"	\$78.95
BSR-10	1.3370	1.0420	6-7/8"	9-3/4"	\$104.95

UNIBIT® DRILL BITS



These amazing drill bits will make sheet metal work a snap! One Unibit will drill many different size holes. Each step will drill through material up to 1/8" thick.

PART	HOLES	RANGE	SHANK	PRICE
UNIBIT-1	13	1/8"-1/2"	1/4"	\$26.95
UNIBIT-3	9	1/4"-3/4"	3/8"	\$39.95
UNIBIT-20	8	9/16"-1.0"	1/2"	\$48.95
UNIBIT-21	10	13/16"-1-3/8"	1/2"	\$100.95
UNIBIT-4	12	3/16 - 7/8"	3/8"	\$59.95
UNIBIT-5	10	1/4-1-3/8"	1/2"	\$100.95

UNIBIT® COBALT STEP DRILL



These Cobalt Step Drill Unibit lasts 6X longer than most. M35 grade Cobalt HSS. Radial concave flute. Speedpoint™ tip. Has laser marked sizes.

PART	DESC	HOLE SIZE	STEPS	INC	PRICE
10231CB	#1	1/8"-1/2"	13	1/32"	\$33.95
10233CB	#3	1/4"-3/4"	9	1/16"	\$59.95
10234CB	#4	3/16"-3/4"	12	1/16"	\$89.95
10239CB	#9	7/8"&1-1/8"	2	1/2" & 3/4"	\$95.95
10220CB	#20	9/16"-1"	8	1/16"	\$69.95

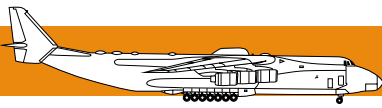

DRILLING EQUIPMENT

SHAVIV™ HEAVY DUTY DEBURRING TOOL



All aluminum handle and solid steel construction makes the Shaviv HD Deburring Tool the standard in the Tool and Die industry. Sharp deburring blades cleanly removes burrs from aluminum, steel, and plastics. Includes B10 and B20 blades.

- SVBHD.....(Deburring Tool with B10 & B20 Blades)..... \$16.95
- SV-B10(Standard Blade)..... \$1.95
- SV-B20(Heavy Duty Version of B10) \$1.95
- SV-B11(Small Hole Deburring Blade) \$2.05
- SV-B30(Two-Way Internal/External Blade)..... \$2.25
- SV-B70(Carbide Sheet Metal Edge Scraper) \$7.95
- SVB2(Economy Deburring Tool) \$4.95

ATS SPEED DEBURRING TOOL



Deburr holes fast and easy with speed handle.

- SP275A(8" OAL "Stubby") \$18.95
- SP375A(10" OAL Standard)..... \$18.95
- SP375-1(Replacement Cutter Tips) \$9.95

TWO-WAY DEBURRING TOOL

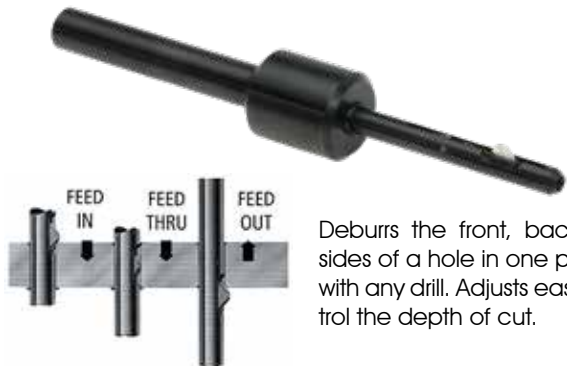

Deburs the front, back or both sides of a hole in one pass. Works with any drill. Adjusts easily to control the depth of cut.

PART	HOLE SIZE	LENGTH	PRICE
TD001	3/32"	3-3/8"	\$134.95
TD002	1/8"	3-3/8"	\$105.95
TD003	5/32"	3-3/8"	\$100.95
TD004	3/16"	3-3/8"	\$110.95
TD005	1/4"	3-3/8"	\$115.95

STRAP DUPLICATORS



For drilling duplicate matching holes in overlapping sheets. Drill Guide Duplicators lets you drill directly by using the duplicator as a drill guide.

SIZE	TYPE	6" CAPACITY		12" CAPACITY		18" CAPACITY	
		P/N	PRICE	P/N	PRICE	P/N	PRICE
40	punch	51	\$14.95	51-12	\$18.95	51-18	\$29.95
30	punch	52	\$14.95	52-12	\$18.95	52-18	\$29.95
21	punch	53	\$14.95	53-12	\$18.95	53-18	\$29.95
12	punch	55	\$14.95	55-12	\$18.95	55-18	\$29.95
40	drill	61	\$10.95	61-12	\$14.95	61-18	\$24.95
30	drill	62	\$10.95	62-12	\$14.95	62-18	\$24.95
21	drill	63	\$10.95	63-12	\$14.95	63-18	\$24.95
12	drill	65	\$10.95	65-12	\$14.95	65-18	\$24.95
40	inverted	71	\$10.95	71-12	\$14.95	71-18	\$24.95
30	inverted	72	\$10.95	72-12	\$14.95	72-18	\$24.95
21	inverted	73	\$10.95	73-12	\$14.95	73-18	\$24.95
12	inverted	75	\$10.95	75-12	\$14.95	75-18	\$24.95

AVERY SPEED DEBURRING TOOL



Swivel action makes deburring and countersink holes fast and easy. Molded handle with 2" long plated steel shaft with 1/4"-28 threaded holder.

Includes (1) 3/8" X 100° 3-flute burring cutter and 8" extension shaft for deburring the inside of flanges and other areas.

- AE1046..... \$34.95
- AE1050.....(3 Flute Burring Cutter Bit)..... \$17.95

STUBBY DEBURRING TOOL

Compact deburring tool easily reaches tight areas. Sharp cutting head removes burrs from tubing up to 3/4" ID, as well as drilled holes in sheet metal up to 1/2" diameter.



- GT196 \$11.95



DRILL HOUSING AND BUSHINGS



A hand held guide to keep drills and taps 90° to flat or curved surfaces. The guide assembly is a transparent plastic housing that allows you to view your work as you drill. And the hardened steel bushing (must be ordered separately) securely guides the bit as you drill. The bushings can be interchanged in one housing.

- DH01 (Drill Housing Only) \$10.95
- DB-40 (40 Drill Bushing) \$7.95
- DB-30 (30 Drill Bushing) \$7.95
- DB-21 (21 Drill Bushing) \$7.95
- DB-10 (10 Drill Bushing) \$7.95
- DB-1/4 (1/4" Drill Bushing) \$7.95
- DH01-KIT..... (Drill Housing & 40, 30, 21, 10 Bushings)..... \$39.95

CHIP CHASER



All steel construction for long dependable life. Ideal for removing chips from between metal after drilling rivet holes.

- SP2005S (2.5" Stubby) \$3.95
- SP2005 (6" Standard) \$4.95
- SP2005K (6" & 2.5") \$7.95

HOLE TRANSFER PINS



Great for aligning overlapping holes. Just place the pin in the hole of the lower sheet with the point facing up, then place the overlapping sheet in place and tap lightly. Leaves a clear prick point for drilling. Sold in packs of 5.

- BHP-1/8 (1/8", 5 pcs) \$4.95
- BHP-5/32 (5/32", 5 pcs) \$4.95
- BHP-3/16 (3/16", 5 pcs) \$4.95
- BHP-1/4 (1/4", 5 pcs) \$4.95

DUPLICATING/TRANSFER PUNCH



Used to mark holes in overlapping sheets. Overall length of 3-1/2".

PART	SIZE	PRICE	P/N	SIZE	PRICE
TP-40	40	\$8.95	TP-21	21	\$7.95
TP-30	30	\$8.95	TP-10	10	\$7.95

DRILL EXTENSION



Used to extend drill bits, pilot cutters, etc. Has a 1/4" shank on one end to fit into a chuck, and a 1/4" x 28 internal thread at the other.

- 382..... (2" Long) \$4.95
- 384..... (4" Long) \$6.95
- 387..... (7" Long) \$6.95
- 3810..... (10" Long) \$7.95

DUAL THREADED DRILL EXTENSION



Used to extend drill bits, pilot cutters, etc. Has a 1/4" x 28 external (male) thread on the shank end, and a 1/4" x 28 internal (female) thread at the other.

- T382 (2" OAL) \$5.95
- T384 (4" OAL) \$6.95
- T387 (7" OAL) \$7.95
- T3810 (10" OAL) \$8.95

HEX POWER DRIVER DRILL EXTENSION



Used to extend drill bits, pilot cutters, etc. Has a 1/4" Hex Drive on the shank end, and a 1/4" x 28 internal (female) thread at the other.

- H382 (2" OAL) \$6.95
- H384 (4" OAL) \$7.95
- H387 (7" OAL) \$8.95
- H3810 (10" OAL) \$9.95



DRILLING EQUIPMENT

TWO LUG - DOUBLE WING

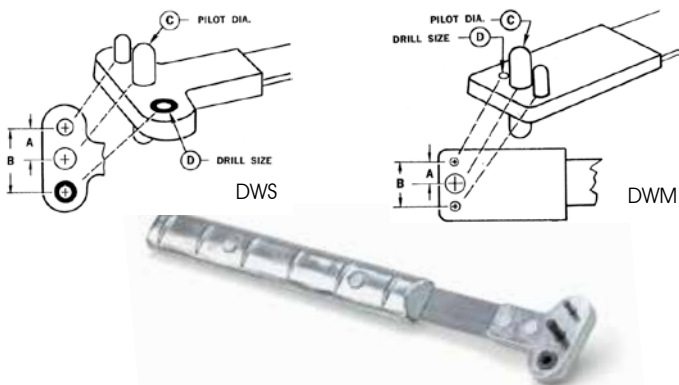

PART	SCREW SIZE	A SPACING	B SPACING	C PILOT DIA.	D DRILL SIZE	PRICE
STANDARD (DWS)						
518A	6	.344	.688	.139	40	\$38.95
518B	8	.344	.688	.164	40	\$38.95
518C	10	.344	.688	.191	40	\$37.95
518D	1/4	.500	1.000	.248	40	\$37.95
MINIATURE (DWM)						
518NB	6	.218	.436	.139	40	\$41.95
518NC	8	.234	.468	.164	40	\$41.95
518ND	10	.250	.500	.191	40	\$41.95
518NE	1/4	.281	.562	.248	40	\$41.95

CORNER WING

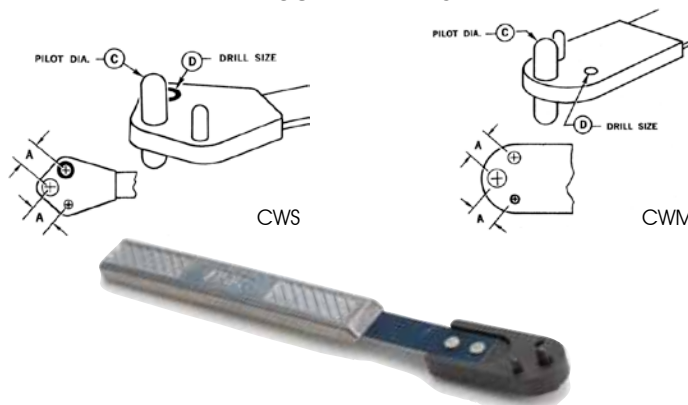

PART	SCREW SIZE	A SPACING	C PILOT DIA.	D DRILL SIZE	PRICE
STANDARD (CWS)					
518R	6	.344	.139	40	\$39.95
518S	8	.344	.164	40	\$41.95
518T	10	.344	.191	40	\$42.95
518U	1/4	.500	.248	40	\$41.95
MINIATURE (CWM)					
518SB	6	.218	.139	40	\$47.95
518SC	8	.234	.164	40	\$47.95
518SD	10	.250	.191	40	\$47.95
518SE	1/4	.281	.248	40	\$75.95

ONE LUG - SINGLE WING

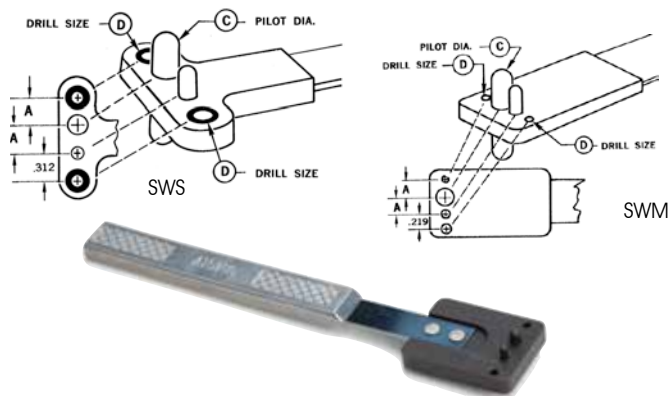

PART	SCREW SIZE	A SPACING	C PILOT DIA.	D DRILL SIZE	PRICE
STANDARD (SWS)					
518G	6	.344	.139	40	\$37.95
518H	8	.344	.164	40	\$38.95
518J	10	.344	.191	40	\$37.95
518K	1/4	.344	.248	40	\$37.95
MINIATURE (SWM)					
518PB	6	.218	.139	40	\$42.95
518PC	8	.234	.164	40	\$41.95
518PD	10	.250	.191	40	\$41.95
518PE	1/4	.281	.248	40	\$41.95

NUTPLATE INSTALLATION BLOCK



Install nut plates faster, easier, and with less damage to the surface and paint with this innovative new product. The Nut Plate Block will produce a flush nut plate on the back side and the rivet will be flush to the skin surface every time. It takes less than 1 minute to install a nut plate. Patent Pending.

CA-NPB10.....	(10-32).....	\$35.95
CA-NPB8.....	(8-32).....	\$35.95
CA-NPB4.....	(4-40).....	\$35.95
CA-NPB6.....	(6-32).....	\$35.95
CA-NPB-1/4.....	(1/4-20).....	\$35.95

V-BLOCK DRILL GUIDE



Drilling through the center of round stock can be a daunting task without the right tool. The precision drill guide makes easy work of it by securely holding the stock in its cradle to stop the tube from rolling or slipping as you drill.

CIT01.....	(Center It).....	\$15.95
EDF1.....	(Drill Rite™).....	\$62.95



ATS MINI BELT SANDER



- 360° Head Rotation
- Uses 3/8" x 13" (10 x 330 mm) Belts
- 16,000 RPM
- 11-3/16" (284 mm) Overall Length
- Built-in Regulator
- 1.76 lbs (.8 kg)

7.0 CFM Removing old paint and corrosion from channels, tracks, and other tight areas is always a challenge. But this sander will make your life easier. It's narrow enough to get into hard-to-reach areas, and powerful enough to make short work of it. Ideal for use on all composite type aircraft projects or contouring and finishing molds and jigs.

ATS4501A	\$95.95
87885 Belts (3/8" x13") 60 Grit.....	\$15.95
87886 Belts (3/8" x13") 80 Grit.....	\$15.95
87887 Belts (3/8" x13") 100 Grit.....	\$15.95

*Belts are in packages of 5.

ATS COMPACT FINGER SANDER



- 15,000 RPM Free Speed
- 2.375" x. 825"(60x21mm) pad size
- Orbital diameter 3mm
- Heavy duty orbital head
- 9-7/16" (240 mm) Overall Length
- 2.2 lbs (1 kg)
- 7.0 CFM

This tool is great for removing paint and corrosion in narrow, confined areas such as seat tracks, or guide rails. High speed orbital action quickly removes material while giving you total control. Uses standard adhesive-backed sandpaper.

ATS4103A	\$169.95
-----------------------	-----------------

ATS HEAVY DUTY JITTERBUG SANDER



- Free Speed 8,000 osc/min
- 6-11/16" (170mm) Overall Length
- Pad Size 3-3/4" x 9" (93 x 228mm)
- 4.33 lbs (1.97kg) weight
- 8.5 CFM

Our jitterbug sander provides the ultimate balance of power and controllability. Ideally suited for paint removal and surface preparation work.

ATS4211	\$65.95
----------------------	----------------

ATS HD RANDOM ORBITAL SANDER WITH VACUUM COLLECTOR



- Free Speed 10,000 RPM
- Head Length 1.08" (2.7 mm)
- 5" or 6" (127 or 152mm) Disc Size
- 2.4 lbs (1.1 kg)
- 4-25/32" (121mm) Overall Length
- Includes vacuum hose and bag
- 7.0 CFM

Excellent high speed finishing sander cuts very quickly and features an internal self-generated vacuum system to remove debris as you sand.

ATS4201V (6" Hook and Loop Pad)	\$145.95
--	-----------------



DIE GRINDERS & SANDERS

ATS REAR EXHAUST EXTENDED DIE GRINDERS



These grinders combine all the features of a well engineered die grinder with the extra reach needed to get into tight areas. They have full ball bearing construction for exceptionally smooth running action. The rear exhaust system vents air away from the work area and prevents contamination from blowing debris.

- 25,000 RPM Free Speed
- 1/4" (6.4 mm) Collet Size
- Rear Exhaust
- .3 HP (.22 kw)

ATS253E.....(3" Die Grinder).....\$129.95
ATS255E.....(5" Die Grinder).....\$145.95

ATS MINI DIE GRINDERS



At only 6" long, our Mini Die Grinders are small enough to fit comfortably in your hand, yet has all of the speed and power of the bigger models. Manufactured from top quality parts and features full ball bearing supports. Use it with rotary files, or Scotch-Brite Roloc discs to shape and polish your work.

- 1/4" (6.4 mm) Collet size
- Front exhaust cleans work area
- 2hp (.15 kw) horsepower
- Full 1 year warranty

PART	STYLE	RPM	WEIGHT	PRICE
ATS5101	Straight	26,000	.79 lbs (.36 kg)	\$79.95
ATS5105	Angle	20,000	1.1 lbs (.5 kg)	\$85.95
ATS5107	115 Degree	20,000	1.1 lbs (.5 kg)	\$89.95

ATS 17 PIECE MICRO DIE GRINDER KIT



A complete rear exhaust micro die grinder kit features a powerful die grinder and a collection of stones in various shapes and sizes. Also included in the kit are:

- 1 - Mini Oiler
- 10 - Grinding Stones
- 1 - Set of spanners
- 1 - 1/4" Air Connector

Micro Die Grinder Specifications: 54,000 RPM Free Speed, 1/8" (3mm) Collet Size, 5-3/8" (137mm) overall length, .44 lbs (.2 kg) weight, rear exhaust.

ATS5001K.....\$115.95

ATS HIGH SPEED MICRO DIE GRINDER



The very high speed and pencil-thin form factor makes this die grinder the perfect tool to do detailed grinding, polishing, or drilling in all types of metals and composites. Ball bearing construction gives it a remarkably smooth and quiet operation.

- 1/8" (3 mm) Collet Size
- Rear Exhaust
- 60,000 RPM Free Speed
- Very light weight .48 lbs (.22 kg)
- 5.86" (149 mm) OAL
- Full 1 year warranty

ATS5023.....\$95.95

Need more information about a product?

Visit our website at www.aircraft-tool.com to find out more about our tools. There you'll find complete descriptions, plus additional pictures and videos of our products. You may also call us at 1-800-248-0638 to speak to one of our representatives if you require more specific help.

DIE GRINDERS & SANDERS



CYLINDER SHAPE CARBIDE BURRS (TYPE SA)



SIZE	SINGLE CUT		DOUBLE CUT	
	PART	PRICE	PART	PRICE
1/4 x 5/8	SA-S1	\$11.95	SA-D1	\$11.95
3/8 x 3/4	SA-S3	\$16.95	SA-D3	\$16.95
1/2 x 1	SA-S5	\$18.95	SA-D5	\$18.95
5/8 x 1	SA-S6	\$24.95	SA-D6	\$24.95
3/4 x 1	SA-S7	\$26.95	SA-D7	\$50.95

TREE SHAPE POINTED CARBIDE BURRS (TYPE SG)

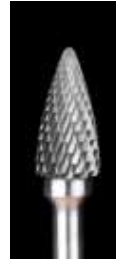

SIZE	SINGLE CUT		DOUBLE CUT	
	PART	PRICE	PART	PRICE
1/4 x 5/8	SG-S1	\$13.95	SG-D1	\$13.95
3/8 x 3/4	SG-S3	\$14.95	SG-D3	\$14.95
1/2 x 1	SG-S5	\$20.95	SG-D5	\$20.95
5/8 x 1	SG-S6	\$26.95	SG-D6	\$26.95
3/4 x 1	SG-S7	\$41.95	SG-D7	\$41.95

CYLINDRICAL RADIUS END CARBIDE BURRS (TYPE SC)



SIZE	SINGLE CUT		DOUBLE CUT	
	PART	PRICE	PART	PRICE
1/4 x 5/8	SC-S1	\$10.95	SC-D1	\$10.95
3/8 x 3/4	SC-S3	\$11.95	SC-D3	\$13.95
1/2 x 1	SC-S5	\$18.95	SC-D5	\$18.95
5/8 x 1	SC-S6	\$24.95	SC-D6	\$24.95
3/4 x 1	SC-S7	\$38.95	SC-D7	\$38.95

FLAME SHAPE CARBIDE BURRS (TYPE SH)



SIZE	SINGLE CUT		DOUBLE CUT	
	PART	PRICE	PART	PRICE
1/4 x 5/8	SH-S1	\$25.95	SH-D1	\$16.95
5/16 x 3/4	SH-S2	\$13.95	SH-D2	\$13.95
1/2 x 1-1/4	SH-S5	\$20.95	SH-D5	\$20.95
5/8 x 1-7/16	SH-S6	\$47.95	SH-D6	\$47.95
3/4 x 1-5/8	SH-S7	\$64.95	SH-D7	\$64.95

BALL SHAPE CARBIDE BURRS (TYPE SD)



SIZE	SINGLE CUT		DOUBLE CUT	
	PART	PRICE	PART	PRICE
1/8	SD-S11	\$9.95	SD-D11	\$9.95
1/4	SD-S1	\$11.95	SD-D1	\$11.95
3/8	SD-S3	\$12.95	SD-D3	\$12.95
1/2	SD-S5	\$18.95	SD-D5	\$18.95
5/8	SD-S6	\$21.95	SD-D6	\$21.95

90° TAPER SHAPE CARBIDE BURRS (TYPE SK)



SIZE	SINGLE CUT		DOUBLE CUT	
	PART	PRICE	PART	PRICE
1/4 x 1/8	SK-S1	\$10.95	SK-D1	\$10.95
3/8 x 3/16	SK-S3	\$13.95	SK-D3	\$13.95
1/2 x 1/4	SK-S5	\$16.95	SK-D5	\$17.95
5/8 x 5/16	SK-S6	\$38.95	SK-D6	\$39.95
3/4 x 3/8	SK-S7	\$25.95	SK-D7	\$25.95

OVAL SHAPE CARBIDE BURRS (TYPE SE)

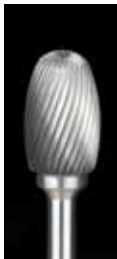

SIZE	SINGLE CUT		DOUBLE CUT	
	PART	PRICE	PART	PRICE
1/4 x 3/8	SE-S1	\$14.95	SE-D1	\$13.95
3/8 x 5/8	SE-S3	\$14.95	SE-D3	\$14.95
1/2 x 7/8	SE-S5	\$19.95	SE-D5	\$20.95
5/8 x 1	SE-S6	\$25.95	SE-D6	\$26.95
3/4 x 1	SE-S7	\$35.95	SE-D7	\$38.95

CONE SHAPE CARBIDE BURRS (TYPE SM)



SIZE	SINGLE CUT		DOUBLE CUT	
	PART	PRICE	PART	PRICE
1/4 x 1/2	SM-S1	\$11.95	SM-D1	\$11.95
1/4 x 3/4	SM-S2	\$11.95	SM-D2	\$11.95
1/4 x 1	SM-S3	\$13.95	SM-D3	\$13.95
1/2 x 7/8	SM-S5	\$20.95	SM-D5	\$20.95
5/8 x 1	SM-S6	\$28.95	SM-D6	\$28.95

TREE SHAPE RADIUS CARBIDE BURRS (TYPE SF)

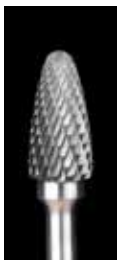

SIZE	SINGLE CUT		DOUBLE CUT	
	PART	PRICE	PART	PRICE
1/4 x 3/4	SF-S1	\$12.95	SF-D1	\$12.95
3/8 x 3/4	SF-S3	\$15.95	SF-D3	\$15.95
1/2 x 1	SF-S5	\$25.95	SF-D5	\$24.95
5/8 x 1	SF-S6	\$33.95	SF-D6	\$33.95
3/4 x 1	SF-S7	\$38.95	SF-D7	\$38.95

INVERTED CONE SHAPE CARBIDE BURRS (TYPE SN)



SIZE	SINGLE CUT		DOUBLE CUT	
	PART	PRICE	PART	PRICE
1/4 x 5/16	SN-S1	\$11.95	SN-D1	\$11.95
3/8 x 3/8	SN-S2	\$12.95	SN-D2	\$12.95
1/2 x 1/2	SN-S4	\$19.95	SN-D4	\$19.95
5/8 x 3/4	SN-S6	\$30.95	SN-D6	\$30.95
3/4 x 5/8	SN-S7	\$43.95	SN-D7	\$43.95

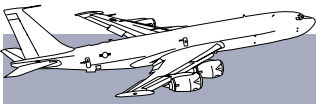

DIE GRINDERS & SANDERS

SOLID CARBIDE ROTARY BURR SET

A complete set of 1/4" shank rotary burrs designed to shape and trim steel, cast iron, and other ferrous metals. Also ideal for use with composite materials. Can be used with any die grinder or high speed drill. Each set contains a selection of nine cylindrical (Type-SA) and tree shaped (Type-SF) carbide burrs suitable for most applications. Comes complete with case. Not recommended for use on aluminum.



CB-S9 (9pcs - 1/4" Shank) **\$59.95**

CARBIDE BURR SET FOR ALUMINUM

This set of 1/4" shank carbide burrs is specifically designed to cut aluminum and other non-ferrous metals without galling or loading up. Includes one each: SA-3NF & SA-5NF cylindrical, SC-3NF & SC-5NF radiused cylindrical, SD-5NF ball, SF-5NF tree taper, and SL-3NF tapered.



CB-A9 (8pcs - 1/4" Shank) **\$85.95**

1/8" SHANK 50 PCS DIAMOND GRINDING BITS

Diamond bits are ideally suited for hard materials such as glass, ceramics, and carbon composites. Contains a variety of the most popular sizes and shapes, such as: ball, cylinder, taper, inverted cone, radius end, discs, and more. Includes a molded plastic case.



WT4999-9915 (50pcs - 1/8" Shank) **\$29.95**

DIAMOND MOUNTED POINT SETS

Mounted diamond point sets range in diameter from 1/16" to 5/16" in an assortment of shapes. Useful for trimming, hole resizing, precision fitting, etching, etc. Works best with hard materials such as glass, ceramics, and carbon composites.



WT4999-9910 (10pcs - 1/4" Shank) **\$6.95**

WT4999-9900 (20pcs - 1/8" Shank) **\$8.95**

ATS HIGH SPEED CUT-OFF TOOL



16413

Perfect for cutting and trimming studs and bolts. Features a safety hood to protect against flying debris. 3" (75 mm) disc capacity, 3/8" (15 mm) mount. Free speed 20,000 RPM. Weight 1.74 lbs (.79 kg).

ATS8502 (Cutoff Tool) **\$49.95**

16413 (Arbor for 1/4" & 3/8" Holes) **\$6.95**

REINFORCED CUT-OFF WHEELS

Premium quality cut-off wheels has high cut rates and long life. Provides top level grinding for fiberglass, stainless steel, mild steel, and alloys. 25,000 maximum RPM. Type-1 Grade 60 Aluminum Oxide suitable for all metals except Titanium.



Always use an approved face shield when using any style of cut-off wheels.

PART	QTY	SIZE	PRICE
MG90-3-2	5	2"x1/32"x3/8"	\$8.95
MG90-3-3	5	3"x1/32"x3/8"	\$8.95
MG90-3-4	5	4"x1/32"x3/8"	\$10.95

MINI GRINDER



- Mini-Grinder
- 2 pcs diamond bits
- 2 pcs grinding stones
- 2 pcs sanding bands
- 1 pc collet (Ø 2.4/ Ø3.2 mm)
- 1 pc nylon brush
- 1 pc engraving bit
- 1 pc connective post for sanding band

This mini grinder has low vibration, high torque and lightweight economically designed. The naturally and comfortable operation body shape makes it easy to complete all of the finishing touches on your project. The quick-change chuck is ideal for drilling, polishing engraving, routing, shaping, sanding and milling.

PT-5201A **\$25.95**

SURFACE PREP TOOLS



ATS SURFACE CONDITIONING KIT



- Includes the following:
- 1 - Coarse Surface Prep Disc
 - 10 - 80 Grit Sanding Discs
 - 1 - Medium Surface Prep Disc
 - 10 - 100 Grit Sanding Discs
 - 1 - Fine Surface Prep Disc
 - 10 - 120 Grit Sanding Discs

A complete sanding and finishing kit that contains a high speed angle sander plus an assortment of 3" sanding discs and surface preparation pads. *Sander Specifications: 18,000 RPM Free Speed, 3" (76mm) Pad Size, 4-23/32" (120mm) overall length, 1.49 lbs (.68 kg) weight.*

ATS4106K.....\$135.95

ATS RIVET SPOT SAND BLASTER



This sand blaster is self-contained and gets down to the bare metal. Ideal for sand-blasting rivets to remove corrosion and oxidation. The abrasive is re-circulated, no mess to clean up. Contains 4 rubber nozzles for flat surfaces, panel edges, and inside and outside corners. Operates on 60 PSI.

ATS201.....\$39.95

SANDING DETAILER KIT



Ideal for finishing those hard to reach areas. It's spring loaded to put tensions on the abrasive belt. Included in this standard kit is one each of four various grits. Replacement belts available online at www.aircraft-tool.com

PART NUMBER	GRIT	PRICE
12301	Standard Coarser Grits	\$21.95
12302	Standard Finer Grits	\$21.95

MINI ORBITAL DETAIL SANDER



- Free speed 7,500 rpm
- .3HP Air motor
- Orbit dia .060" (1.5 mm)
- Weight 1.42 lbs (.66 kg)
- Length 6-5/8" (168 mm)

The perfect sander for targeted corrosion removal, spot repair of paint jobs, and general finesse sanding of small areas. Front exhaust allows continuous cooling of gear box which extends the life of the tool. Includes a 1-1/4" (30mm) diameter hook and loop (velcro).

ATS4115P.....\$69.95

Hook and Loop Sanding Disc sold in packs of 10.		
PART NUMBER	GRIT	PRICE
ATS4115P-HL (H&L Replacement Pad)\$5.95		
4115-100V-10	100	\$3.95
4115-180V-10	180	\$3.95
4115-220V-10	220	\$3.95
4115-320V-10	320	\$3.95
4115-400V-10	400	\$3.95
4115-600V-10	600	\$3.95
4115-800V-10	800	\$3.95
4115-1000V-10	1000	\$3.95
4115-1200V-10	1200	\$3.95
4115-1500V-10	1500	\$3.95
PSA Sanding Disc sold in packs of 10.		
ATS4115P-PSA (PSA Replacement Pad)\$5.95		
4115-60-PSA	60	\$2.95
4115-120-PSA	120	\$2.95
4115-240-PSA	240	\$2.95
4115-400-PSA	400	\$2.95

For more information about our products, visit our website www.aircraft-tool.com.



SURFACE PREP TOOLS

NYLON CHISEL SCRAPER SET



Titan 4-piece nylon scraper sets are designed to gently but effectively scrape and remove decals, emblems, body moldings, gaskets, and debris without damaging surfaces. These scrapers are made from a durable nylon plastic material that absorbs hammer blows and can be sharpened with a file.

11565..... \$13.95

MULTI WEDGE INTERIOR AND EXTERIOR PANEL TOOL



These multi-wedge pry tool sets are specially designed to gently remove seals, instrument panels, air vents, door panels, door locks, seal levels, and more. These tools feature different wedge shapes that allow you to get under and lift pieces away without damaging delicate surfaces.

15048..... (6 pc) \$9.95

SCRAPER SET WITH NON-MARRING BLADES



This tool is a razor scrapper which also includes a set of non-marring blades. The razor scrapper is effective for removing decals, tail numbers, warning placards, and other markings which must be scrapped off on painted surfaces. The non-marring blade does a similar job but will not damage painted or plastic surfaces. So you get the best of both worlds with one tool.

17008..... (Scraper Set) \$12.95

12038..... (Non-Marring Blades) \$3.95

SCOTCH-BRITE™ HAND PADS



Available in various grades to cover all jobs ranging from light deburring to fine polishing. Each pack consists of 20 pads. Pad size is 6" x 9".

PART	DESCRIPTION	PKG. QTY.	COLOR	PRICE
6444	Extra Duty	20	Brown	\$31.95
6448	Light Duty	20	Dark Gray	\$32.95
7445	Light Duty Cleansing	20	White	\$29.95
7447	General Purpose	20	Maroon	\$31.95
7448	Ultra-Fine	20	Light Gray	\$31.95
961H	Twist-Lok Pad Holder			\$7.95

SCOTCH-BRITE™ HAND PAD TRIAL PACK



A convenient pack of assorted 6"x 9" hand pads lets you decide which product is right for your application. Each pack contains one of the following:

- Scrubbing Sponge.
- TWIST-LOK pad holder (961)
- Extra duty pad (6444)
- Light duty pad (6448)
- Heavy duty pad (7440)
- Cleansing pad (7445)
- Blending Pad (7446)
- General purpose pad (7447)
- Ultra fine pad (7448)

961S..... \$31.95

PILOTED BONDING BRUSH



Stainless steel brush used to clean away corrosion and paint buildup. 1/4" shank and 1/2" diameter.

PART	PILOT	PRICE	P/N	PILOT	PRICE
06721	3/32"	\$18.95	06781	3/16"	\$18.95
06741	1/8"	\$18.95	06801	1/4"	\$20.95
06761	5/32"	\$18.95			

SURFACE PREP TOOLS



3M ROLOC™ DISC PADS



For use with 3M Roloc™ discs. The pads are made of medium grade rubber and has a female thread to accept any standard 1/4x20 threaded shaft.

- RLP2(2" Pad and Shaft) \$21.95
- RLP3(3" Pad and Shaft) \$28.95
- RLTS(Threaded Shaft)..... \$3.95

3M™ STRIPE-OFF GRAPHICS REMOVAL WHEEL



The 3M Stripe-Off Graphics Removal Wheel is great for removing stripes, decals, or tail numbers from airplanes without damaging the paint finish. Comes ready to use in any air or electric drill. Includes complete instructions. 4" dia x 5/8" wide.

- 3M7498..... \$42.95

3M GRAPHICS REMOVAL DISC



Graphics removal discs provide the best way to remove vinyl decals, graphics, tapes, films and adhesives. Their unique construction assures a long life and allows easy conforming to contours. Because the discs are flexible and have no sharp edges, they will not damage underlying paint. 4" Dia. x 3/8" wide. Requires 1 Roloc Holder.

- GRD1..... \$25.95

3M 6" CUT AND POLISH WHEEL

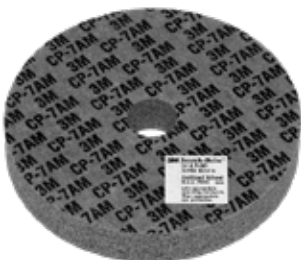

3M Cut and Polish wheel, Medium Grade, 6" Diameter x 1" wide x 1/2" arbor hole. Perfect for deburring and blending aluminum.

- CP7AM \$100.95

3M SCOTCH-BRITE™ ROLOC DISCS



Scotch-Brite™ discs are excellent for general purpose surface finishing. They provide a burr-free surface suitable for painting or fine polishing. Use them to remove light corrosion, oxides, and coatings. Sold in packs of five discs.

PART	GRADE	DIA.	PRICE (5 PCS)
SBD05528	A CRS	2"	\$9.95
SBD05532	A CRS	3"	\$10.95
SBD05527	A MED	2"	\$10.95
SBD05531	A MED	3"	\$13.95
SBD05523	A VFN	2"	\$9.95
SBD05530	A VFN	3"	\$13.95
SBD05522	S SFN	2"	\$10.95
SBD05529	S SFN	3"	\$14.95

PAINT CUTTERS



PA36-5XX



WITHOUT PAINT CUTTER

WITH PAINT CUTTER



PA36-666

You know how frustrating it can be to remove a painted over screw only to wind up chipping up the paint job. But you wouldn't have that problem if you had a set of these innovative paint cutters. They work by slicing through the paint around the head of the screw so you can remove it without chipping the paint. They have a 1/4-28 thread to fit into any angle drill, or you can get the optional arbor for use in a drill chuck.

PART	DESCRIPTION	PRICE
PA36-511	4 Screw Paint Cutter	\$24.95
PA36-512	6 Screw Paint Cutter	\$24.95
PA36-513	8 Screw Paint Cutter	\$24.95
PA36-514	10 Screw Paint Cutter	\$24.95
PA36-517	1/4" Screw Paint Cutter	\$24.95
PA36-666	Optional Paint Cutter Arbor	\$6.95
PA36-SET	Set of all 5 cutters and Arbor	\$116.95



CLEANING & POLISHING

CYCLO 5-PRO MARK II POLISHER



The Model 5-Pro, Mark II is a variable speed version of the Model 5 and also offers a 3 year warranty, plus all the balancing weights (blue, yellow and silver). This tool is equipped with ProGuard Orbital Backing Plates for attaching loop backed foam or wool pads.

Its innovative design eliminates the two main problems that plague rotary polishers: heat build-up that can cause visible burns, gouges and swirls, and vibration. The synchronized movement of the Cyclo Polisher's dual orbiting heads effectively mirrors the overlapping, circular motion of fine hand polishing. The result is a mirror-like finish without swirl marks or risk of damage to paint.

CYCLO5-PRO(Bonnet) \$405.95

ORBITAL BACKING PLATE



The Cyclo Toolmakers ProGuard Orbital Backing Plate features permanently adhered high quality dense hook material (the same material we use on the Rubber Pad Holders). This provides a much better mating hook and much more area of hook material

CY79-112 \$37.95

CYCLO WOOL PADS



Wool pads are typically used to apply polish and to blend out scratches and marks before finishing.

CY72-455 \$37.95

CYCLO FOAM BONNETS AND VELCRO PADS



Foam pads are ideal for applying polishes, sealants, and buffing compounds. They are also superb for fine polishing.

PART	COLOR	DESCRIPTION	PRICE
Velcro (For use with CYCLO5-RPH)			
CY72-110	White	Super Fine Finishing Pad (x4)	\$16.95
CY72-115	Blue	Ex Fine Buffing/Finishing Pad (x4)	\$16.95
CY72-120	Green	Buffing Pad (x4)	\$16.95
CY72-135	Yellow	Blending/Polishing (x4)	\$19.95
CY72-145	Orange	Scratch Removal/Blending (x4)	\$19.95

CYCLO CLEANING BRUSHES



Brushes allows you to use your Cyclo as a cleaning and scrubbing tool. Attaches directly to any Cyclo Polisher unit. 2 brushes per package.

PART	COLOR	DESCRIPTION	PRICE
CY76-810	Gray	Ultra Soft Upholstery Brush	\$45.95
CY76-830	Aqua	Shampoo Brush	\$41.95
CY76-840	White	Carpet Brush	\$41.95
CY76-870	Black	Scrubbing Brush	\$41.95



BUG BLASTER

For use on aircraft, autos, RVs, boats, and motorcycles. Quickly remove bugs without leaving a residue. Just spray, wait and wipe. Bug Blaster instantly attacks bug proteins and acids. Safe on all exterior surfaces including: Plexiglas, acrylic, glass, clear coat or polyurethane paints, etc. Bug Blaster is completely biodegradable. 8 oz.

3MBB1008\$7.95



EXTREME SIMPLE GREEN

Extreme Simple Green's aircraft cleaning product, cuts through tough, built up grease, oil, dirt, pollution, insect residue, and impact soils. Simple Green will not cause harm to aircraft structural metals, plastics, paints, or coatings.

ESGAC32\$14.95



WINDSHIELD CLEANER



3MWIN008



AK8

These cleaners are specially formulated for aircraft transparencies. They contain no wax or solvents. Winbright is a professional strength spray with Micro-Brighteners that leave surfaces sparkling clear and clean without residue. All Klear cleans as well as leaves a thin coating to protect against dirt, and smudges.

3MWIN008.....(WinBright).....\$11.95
AK8.....(All Klear).....\$5.95

MICRO-MESH™ AIRCRAFT WINDOW RESTORATION KIT



The micromesh system uses a series of fine sanding cloths and polishing compounds to restore optical clarity and luster to even the most weather damaged windshield. Use it to restore cockpit visibility to like new condition.

KR-70.....(Restores up to 30 Sq. Ft.).....\$27.95
HP-100.....(Restores up to 60 Sq. Ft.).....\$48.95
3MG8.....(Polish & Scratch Remover 8oz).....\$10.95

MET-ALL® DETAILING POLISHING KIT



MET-ALL's Detail Polishing Kit will produce a show room finish on bare metal, painted surfaces and fiberglass using a variety of Met-All polishes and premium bonnets. Each bonnet features a recessed loop back so the edge of the pad, as well as its face, can be used effectively with less concern for scuffing or marring the finish.

MDPKIT\$37.95

MET-ALL® PREP AND ULTRA POLISH



MA-P37



MA-P100

"Best Aluminum cleaner/polisher I have ever used. It also leaves a finish that is easy to keep clean" ~ J Anderson

A complete two-stage solution to the perfect finish. First, use the Prep Polish to remove roughness. It's thorough cutting action clears away years of oxidation and readies the surface for finish polishing. Next, buff to a mirror-like finish with super-smooth Ultra Polish. Ultra Polish also restores optical clarity to acrylics, as well as removes fine scratches in painted surfaces.

MA-P37.....(16 oz Prep Polish).....\$12.95
MA-P100.....(16 oz Ultra Polish).....\$18.95
MA-UPC.....(16 oz Prep & Ultra Polish Combo).....\$29.95

MET-ALL® ALUMINUM AND STAINLESS STEEL POLISH

Painted or unpainted, MET-ALL's Aluminum and Stainless Steel polish keeps your aluminum and steel surfaces shining bright. Special protective agents remove and prevent oxidation. It's non-abrasive, environmentally safe formula guards against water spots and maintains luster. Non-toxic and non-flammable. Effective in removing accumulated surface dirt and stains from anodized aluminum.



MA-BP2.....(2.5 oz Tube).....\$4.95
MA-TC10.....(16 oz Can).....\$10.95
MA-TC20.....(32 oz Can).....\$19.95



FABRIC & COMPOSITES

MAULE FABRIC TESTER



Test fabric on your airplane for minimum FAA requirements without removing or punching holes in the fabric. Accurately calibrated in pounds (ranges from 25 to 80 pounds). Stainless steel construction. Comes in a protective case.

315.....\$541.95

6 1/2" SPRING ACTION SNIP



Short and narrow blades make for easy access in tight, hard to reach areas. One blade is serrated for nonslip cutting action! Excellent for cutting Kevlar.

743.....(6 1/2").....\$27.95

744.....(6 3/4").....\$30.95

WISS 8.25" PINKING SHEARS



The Wiss 8-1/4 in. pinking shears pinks and cuts reducing the amount of labor. The sawtooth blade design reduces the time spent finishing edges on fabrics. The shears leaves a ruffled edge that will not fray.

CB8.....\$47.95

MICRO-TIP THREADCLIP



Can't reach those threads to snip? Now you can with this micro-tip solid steel ball-bearing style thread clip. Auto spring return action leaves your other hand free to handle material. Attractive chrome finish with soft blue insert for comfort.

VP38.....(With Grip).....\$19.95

HTC-5.....(Without Grip).....\$13.95

TITANIUM NON-STICK SCISSORS



Precision

Straight

Bent Shears

PART	DESCRIPTION	PRICE
18540	4" Titanium Non-Stick Precision Scissors	\$6.95
18541	5" Titanium Non-Stick Precision Scissors	\$9.95
18542	7" Titanium Non-Stick Straight Scissors	\$12.95
18543	8" Titanium Non-Stick Straight Scissors	\$15.95
18544	8" Titanium Non-Stick Bent Shears	\$15.95
18545	9" Titanium Non-Stick Bent Shears	\$18.95

FLORIAN ROTARY PINKER™



The Florian Rotary Pinker™ has been proven since the mid-1930's. Makes one continuous pinked edge with comfortable right or left hand use. Easily pinks the most intricate patterns with a light and compact touch. One year warranty.

FL12.....\$100.95

BENT EXTREME EDGE TITANIUM BONDED SHEARS



Titanium bonded shears are 3 times harder than stainless steel so they stay sharper longer. The blades will resist chemicals, adhesives and corrosion, and the bent ergonomic handles are designed to reduce stress while cutting to minimize fatigue. Ideal for cutting fabrics such as canvas, upholstery material and leather. Includes hex key tool for adjusting tension to the type of material you need to cut.

18523.....(8").....\$17.95

18524.....(9").....\$21.95

18527.....(11").....\$26.95

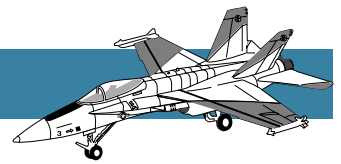

ARCH PUNCH SET

NEW



Seven-piece Arch Punch Set is ideal for punching round holes in gasket material, leather, rubber, canvas, cardboard, plastic, sheet metal and other soft materials. Made of heat-treated forged steel with an inside taper for clearance. Hole diameters: 1/4 in., 3/8 in., 1/2 in., 5/8 in., 3/4 in., 7/8 in. and 1 in. Includes Plastic roll pouch.

GT1271ST \$75.95

REVOLVING PUNCH PLIERS



A convenient spring tension, self opening tool for punching round holes in leather, plastic, rubber, canvas and similar materials. Punches holes: 5/64", 3/32", 7/64", 1/8", 5/32", & 3/16".

722..... \$9.95

GASKET PUNCH SET 10PC



This professional gasket punch set offers everything you will need to effortless punch holes in gasket material, leather, canvas, cardboard and soft sheet metal . This 10 piece kit features nine hardened and tempered punches and a self-centering steel mandrel.

The set includes gasket punch sizes 1/4, 5/16, 3/8, 7/16, 1/2, 5/8, 3/4, 7/8, and 1 inch. The entire gasket punch set is packaged in a fitted plastic case for easy storage.

GTS1274..... \$57.95

6 3/4" UPHOLSTERY SHEAR



Light, large synthetic handles and stainless steel blades are excellent for trimming fabric material. One blade serrated. For both right or left handed use. 6 3/4" overall length, 1 3/4" cut length. Fabric, furniture making, sewing.

545..... \$11.95

UTILITY GROMMET KITS



Each easy-to-use set includes a hardened steel hole cutter, a matched mandrel/anvil pair, a hardwood backer block and an assortment of grommets. We offer three kit sizes (1/4", 1/2 and 3/8") as well as the option to purchase additional grommets.

GT71260	(1/4")	\$7.95
GT71262	(3/8")	\$8.95
GT71264	(1/2")	\$8.95
GT1261-0	(24 Refill 1/4" Grommets)	\$1.95
GT1261-2	(12 Refill 3/8" Grommets)	\$3.05
GT1261-4	(12 Refill 1/2" Grommets)	\$4.95

6 PIECE HOLLOW STEEL PUNCH SET

NEW



This hollow steel punch set provides tools for making various sized holes, includes 3/16", 1/4", 5/16", 3/8", 7/16", and 1/2" hole punches in a plastic roll pouch. The punch works on leather, rubber, gasket material, cardboard and softer metals. The internal punch features a side clearance hole for easy removal of punched material.

GT1280ST \$42.95



SHEET METAL TOOLS

DAGGER PANEL BEATER AND DOLLY KIT



The most widely used selection of panel beaters and dollies for most metal shaping needs, professional grade tools in a molded plastic box. Each hammer is color-coded for either shrinking (blue) or stretching (red) forming tasks. The three panel beaters included are the dinging, shallow-domed face, and pick hammer combo. The dollies

included are the thin toe, utility, curved, and heel shapes, providing the user with the best combination kit on the market.

DTCP07K.....\$167.95

ROUND SHOT BAGS



Heavy duty shot bags are made from .070"/.090" top grain cowhide for extended life, and to produce a blemish-free metal surface. Approximately 1-1/2" to 2" when filled.

DTSB8 (8" Diameter)\$27.95

DTSB12 (12" Diameter)\$39.95

SQUARE SHOT BAG

Heavy-duty leather bag filled with 2-1/2 lbs. of shot. Used to stretch and form metal without nicks or gouges. 4" wide by 6" long.

55115.....\$49.95



HARDWOOD SLAPPERS



Leather covered wooden slappers are perfect for quick metal shaping without marring the surface. Use it with a leather shot bag to rough form shapes prior to finishing.

PART	SHAPE STYLE	FACE LENGTH	FACE WIDTH	PRICE
DTSLP1	Gentle	8-1/2"	2-1/4"	\$67.95
DTSLP2	Medium	8-1/2"	2-1/4"	\$69.95
DTSLP3	Flat	8"	2-1/4"	\$67.95

SHEET METAL HAMMERS



Heat-treated, dropped forged steel dollies and hammers. Fiberglass hammer handles with non-slip grip. Includes: bumping hammer, pick and finish hammer, reverse curve hammer, utility dolly, double end dolly, shrinking dolly, curve dolly, blow mold case.

PART	DESCRIPTION	PRICE
15084	7 pc Sheet Metal Hammer Set	\$46.95
15079	Straight Finishing Hammer	\$6.95
15080	Shrinking Hammer	\$7.95
15081	Pick Finishing Hammer	\$7.95
15082	8 oz Rubber Mallet	\$4.95
15085	Heel Dolly	\$7.95
15086	Wedge Dolly	\$7.95
15087	General Purpose Dolly	\$7.95

BOSSING MALLETS



High quality bossing mallets are lightweight, resistant to wear, and feature non-marring polyethylene heads. When used with a shot bag, the simplest to very complex shapes can be roughed out and finished with either a planishing hammer or english wheel.

PART	SMALL RADIUS	LARGE RADIUS	HEAD DIA.	PRICE
DTSBM11	7/16"	1"	2"	\$30.95
DTSBM12	1/2"	1-1/4"	2-1/2"	\$35.95
DTSBM13	1/2"	1-1/2"	3"	\$41.95

SPOON DOLLY

For use in hard to reach places. 14"L x 2-1/2"W x 1"H. Wt. 4-3/4 lbs.

55150.....\$53.95



SLAPPING SPOON

The large polished surface provides a broad face to quickly and evenly work the metal. 4" x 2", Wt. 3/4 lbs.

55501.....\$27.95



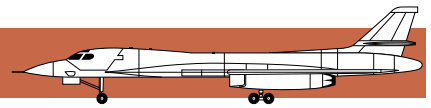

HOLE FLANGING TOOL



Excellent for flanging lightening holes or overlapping sheets. Won't mar material. Flanges straight or curved edges up to 1" deep.

FT100 \$15.95

MALCO REDLINE® HAND CRIMPER



New 5 blade style crimps more evenly. Has 1-1/4" jaw depth. Full 20 gauge capacity. 9" Overall length.

C5R (5 Blade Double Crimper) \$37.95

SC-1 (3 Blade Single Crimper) \$24.95

SHEET METAL JOGGING TOOL

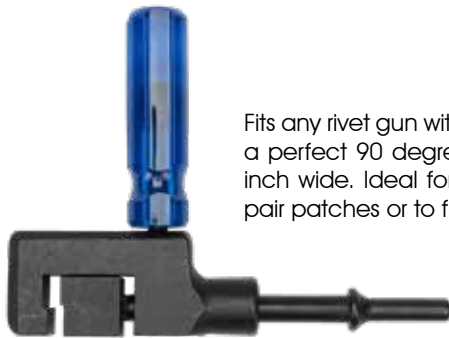

Fits any rivet gun with a .401 shank and forms a perfect 90 degree jog approximately 1/2 inch wide. Ideal for forming sheet metal repair patches or to flush mount full sheets.

91625 \$62.95

TITANIUM BONDED SNIP



A leader in the field due to its Titanium Bonding which provides a surface 3x harder than untreated steel. This allows the snip to stay sharper up to 3x longer. Precision

ground edges on the blades ensure a tight grip on each cut for superior cutting quality. Corrosion and adhesive resistant. Cuts straight, notches and wide curves. For plumbing, heating, air conditioning and roofing trades. Non-slip cushion cold handles for comfort and control. Perfect for cutting low carbon cold rolled steel.

18476 (7") \$17.95

18477 (10") \$20.95

18478 (12") \$24.95

EDGE MARKER BLOCK



This handy device holds a making pen and has an adjustable guide that runs along the edge of a part. The guide allows variable edge distance for rivet layout. One thumb screw holds the pen and the other screw holds the adjustable stop. Comes ready to use with one Pilot marking pen.

AE6352 \$21.95

EDGE ROLLING TOOL



For pre-bending skin edges on lap joints and butt joints before riveting. "Edge rolling" will prevent skin edges from curling up during riveting. Machined round body made from 2024 aluminum. Black anodized finish for wear resistance. Ball bearing style nylon rollers and a spare set of rollers included.

AE1042 \$24.95

AE1040 (Spare Rollers-2) \$3.95

LAP JOINT JOGGLE TOOL



Use for lap joint and inspection hole joggles in aluminum skins up to .032" thick. Steel handle with adjustment slots and precision ball bearing rollers. Adjustable for set back (width of joggle) and for different material thickness.

AE465 \$59.95

AVERY HOLE FLANGING TOOL



For forming flanges around lightening holes. Made from 2024 aluminum and hard black anodized. Ball bearing style rollers. Comes with spare set of rollers.

AE1041 \$18.95



SHEET METAL TOOLS

MINI OFFSET SNIPS



With an overall length of only 7-1/8 inches (181 mm), the AVsMini™ easily goes to work in tight or awkward spaces where full-size aviation snips are challenged. A 3/4 inch (19 mm) length of cut provides the optimum speed for confined cutting applications where this small, maneuverable snip excels. Forged steel jaws with precision-ground serrations on the lower blade produce a sharply defined edge for cutting accuracy and control.

- AVM7EV** (Right Green) **\$15.95**
- AVM6EV** (Left Red) **\$15.95**

WISS ERGONOMIC OFFSET SNIPS



- Offset blades keep hands clear of metal
- Fine serrated jaws require very little (if any) cleanup after cutting
- Cuts up to 18ga (.049") aluminum or steel

Snips are advanced metal cutting tools originally developed for cutting extremely tough alloys used in the aircraft industry. The jaws are made of durable and wear-resistant molybdenum steel.

The serrated offset jaws are designed to make straight or tight circular cuts with equal ease while keeping your hand safely away from the work.

- M6R**.....(Wiss Left and Straight Red)..... **\$24.95**
- M7R**.....(Wiss Right and Straight Green)..... **\$24.95**

CIRCLE CUTTER



This tool, also known as a "Fly Cutter", uses a flying cutting bit to cleanly cut holes in metal, wood, plastic, and hardwoods from 1" to 5-1/2" diameter. The included 1/4" drill bit automatically forms its own pilot hole prior to cutting. The drill shank is 5/16". We strongly recommend a drill-press and safety gear when using this tool.

- 5B**..... **\$18.95**
- 555**..... (Replacement Cutter Blade)..... **\$4.95**

WISS METALMASTER® AVIATION SNIPS



- Ideal for cutting tight curves or intricate patterns in sheet metal
- Fine serrated jaws require very little (if any) cleanup after cutting
- Cuts up to 18ga (.049") aluminum or steel

Wiss Metalmaster® snips were originally developed for cutting extremely tough alloys used in the aircraft industry. The jaws are made of durable and wear-resistant molybdenum steel.

- M1R**..... (Cuts Left and Straight Red) **\$20.95**
- M2R**..... (Cuts Right and Straight Green) **\$20.95**
- M3R**..... (Cuts Straight Yellow)..... **\$21.95**
- MKR**..... (Set of All 3)..... **\$49.95**

ANDY SNIPS®



Superior quality, heavy-duty snips are only 1/3 the weight of steel types, and give many more years of service. Comfortable, sleek contour aluminum handles have reinforcing ribs to duplicate the strength of steel. Handles will not spring when cutting heavy gauges of sheet metal. Inlaid blades are supreme cutlery grade moly steel, electronically heat treated and tempered for continuous use. Precision ground, beveled cutting edges stay sharp longer and make pattern cutting, even circle cuts an easy job. Blades are able to be sharpened and also easily replaced when necessary.

- M12**..... (12" Long, 3" Cut)..... **\$34.95**
- M14**..... (14" Long, 3-1/2" Cut)..... **\$38.95**

LIGHT METAL SNIP



Compact sheet metal snip makes quick work of trimming aluminum, plastic, and sheet steel material. Unique high leverage design will cut up to 24ga metal with virtually no effort. Made of stainless steel.

- K147**..... **\$23.95**



HEAVY DUTY HAND SEAMER



The extra wide 3-3/8" jaw face is machined smooth and aligned to be exactly parallel along the edges. The 6" handle is covered in a thick vinyl for maximum leverage without any discomfort.

HS144.....\$24.95

ECONOMY HAND SEAMER



Locks to work with powerful non-slip grip. Eliminates tiresome hand gripping. Ideal for holding templates or riveting work, welding, etc. Throat depth 1-3/4".

AE575..... (Avery Tools)\$48.95
S7..... (Irwin)\$25.95

BURNISHING TOOL



Designed to remove surface blemishes in aircraft sheet metal. Comfort grip handle.

515A\$11.95

SKIN WEDGE



A skin wedge is the tool to use (instead of a screwdriver) whenever you need to pry and jog sheet metal skins. Just slip the thin curved blade into the gap and slide it along the edge to gently separate the edges without gouging the skin. Can also be used as a jogging tool to align new skin. 7" long by 1" wide.

SWG7\$9.95
SWG7-3..... (Set of 3)\$9.95



HAND TOGGLE CLAMPS

Toggle clamp has a jaw capacity of 1 in. and jaw depth is 1-1/8 in.

145.....\$23.95

ATS DELUXE FLUTING PLIERS



Narrow fluting pliers are used for straightening out or coaxing sheet metal into the correct shape. Great for working on spars, ribs, and bulkheads. Smooth polished faces produce very clean flutes without any marring. 3/16" fluting faces.

FP21\$20.95

WISE GRIP FLUTING PLIERS

Make narrow & precise flutes for straightening ribs and bulkheads easier & better than pliers with molded jaws. Jaws are 3/16" diameter.



AE500..... (Avery Tools)\$48.95
7070..... (ATS Brand)\$39.95

FLUTING PLIERS

Special coating on jaws allows work on aircraft components without marring the surface. Has a 1" reach and will produce a 3/8" flute.



FP10\$19.95

EDGE SCRAPER

Ideal for deburring sheet metal edges. A special guard protects users hand.



SP201A\$11.95

DOUBLE DEBURRING TOOL



Fast, efficient deburring tool designed specifically for sheet metal and composite materials. Replaceable hardened twin cutting wheels deburr sheet metal up to 3/8" thick. Overall length is 7-3/4".

G480\$20.95
G480-RB..... (Replacement Cutting Wheel)\$5.95

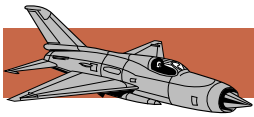

SHEET METAL TOOLS

SCRIBES & AWLS



Special heat-treated for long, dependable service.

PART	DESCRIPTION	PRICE
GT818	Scratch Awl	\$6.95
15045	Scratch Awl	\$8.95
627	Hook and Scribe	\$4.95
GT83	Pocket Scribe with Replaceable Tip	\$4.95
GT83P	Replacement Tip for GT83	\$1.95

INSTRUMENT HOLE PUNCH



Reversible cutter for both 2-1/4" and 3-1/8" instrument panel holes. Easy to use even with instrument panel installed in aircraft. Allows for close work with other instruments already installed.

- 123C \$159.95
- T123C..... (Instrument Hole Drill Template) \$20.95

AN BOLT GAUGE



All metal gauge designed to accurately determine the sizes and lengths of AN bolts up to 5/8" diameter. Self-explanatory, easy to use instructions are written directly on the gauge.

- AE1350..... \$11.95

ADJUSTABLE HOLE CUTTER



This adjustable hole cutter cuts perfect holes from 2" to 12" diameter in 16 ga. metal and wood up to 1" thick. Ideal for cutting out inspection and instrument holes. Uses any air or electric drill.

- HC1 \$69.95
- CB(Replacement Cutter Bit) \$12.95

PRECISION SCREW AND BOLT SHEAR



A precision device to cleanly cut screws and bolts without damaging the threads. Simply insert the screw or bolt into the proper size threaded opening, set the length required, and strike the cutting blade with a hammer to cleave the bolt. It cuts threaded products in sizes of 4-40, 6-32, 8-32, 10-32, 10-24, 1/4-20, and 1/4-28. It will cut steel, stainless steel, aluminum, brass, and even hardened bolts. Comes in a protective pouch and includes complete instructions.

- SBS1 \$115.95

MANUAL PUNCH KIT



- Die set 1/2 in. type C
- Die set 3/4 in. type C
- Die set 1 in. type C
- Die set 1-1/4 in. type C
- Die set 1-1/2 in. type C
- Die set 2 in. type C
- Shaft and bearing - small
- Shaft and bearing - medium

Knockout punch kit is ideal for punching clean holes in metal, fiberglass and plastic materials up to 10 ga thickness. Easy to use, simply drill a pilot hole and place 2 cutters on either side then put the arbor through the cutters and use the included ratchet to bring the cutting jaws together. Includes a set of 6 dies, arbor and ratchet plus a carrying case.

- E902-481 \$174.95

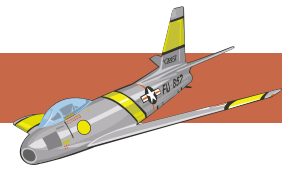

ATS 2" AIR CIRCULAR SAW



NEW FOR 2018

- Uses 2" (51 mm) saw blades
- .080" (2 mm) steel capacity
- .290" (7.5 mm) alum capacity
- 1200 RPM
- Weight 2.42 lbs (1.1 kg)
- Length 6-7/8" (175 mm)

Designed to make precise, controlled cuts in aluminum panels up to 1/4" thick. Leaves a high-luster, burr-free edge that does not require any additional filing or cleanup. Great for cutting out access panels. Excellent balance and smooth operation

ATS8510B	\$179.95
ATS8510B-RB(Replacement Blade).....	\$29.95

ATS PUNCH AND FLANGING TOOL



- Cap 16ga (.060"/15mm) steel.
- Punch Dia 3/16" (5 mm)
- Flange width 1/2" (12 mm)
- Rubber comfort grip
- 9-3/4" (248 mm) OAL
- 2.75 lbs (1.25 kg)

When overlapping two pieces of sheet metal, you must "jog" the edge of one sheet so that they will join together without seams and that's just what this tool does. The jogging die places a nice 1/2" jogging flange on the edge of sheet metal up to 16ga. While the other end of the die contains a hole punch that will make a clean 3/16" hole. This tool is a real time-saver if you do a lot of sheet metal work.

ATS8400..... **\$75.95**

VIBRATION REDUCED SAW KIT



Very low vibration saw is designed to reduce the effects of vibration shock injuries. Cuts at 5000 strokes/min. Operates at 90 psi.

Complete kit includes:

- Saw
- 5 32T Blades
- 5 24T Blades
- 5 18T Blades
- Air Swivel
- Molded Case

ATS8229K..... **\$139.95**

ATS526..... (18 Teeth Bld 5 pc) **\$5.95**

ATS527..... (24 Teeth Bld 5 pc) **\$6.95**

ATS528..... (32 Teeth Bld 5 pc) **\$5.95**

ATS HIGH SPEED RECIPROCATING SAW KIT



- Cuts up to 16 ga (.060" / 15 mm) steel or aluminum
- .063" (1.6, mm) Stroke Length
- 10,000 Strokes Per Minute (SPM)
- Weight 2.1 lbs (1.35 kg.)

Heavy duty saw features safety guards and a locking throttle to prevent accidental starts. At 10,000 strokes per minute, this saw will cut through steel or aluminum just as fast and easily as cutting through wood. Complete kit includes the high speed saw, two sets of blades, mini oiler, a swivel connector, accessory tooling, and a blow molded case.

ATS8202K..... **\$99.95**

ATS526... (Rep Bld, 18TPI, 5 pkg.) **\$5.95**

ATS527... (Rep Bld, 24TPI, 5 pkg.) **\$6.95**

ATS528... (Rep Bld, 32TPI, 5 pkg.) **\$5.95**

For complete selection
visit www.aircraft-tool.com



SHEET METAL TOOLS

ATS HIGH SPEED AIR SHEARS



The powerful jaws breeze through 16ga sheet metal at over 50 feet/min. Great for rough cutting, or finish trimming. Triple blade design cuts without leaving any edge burrs or distortions.

- Cuts up to 16 ga (.060" / 15 mm) steel or aluminum
- Replaceable blades may be sharpened for extended use
- Weight 3 lbs (1.35 kg.)

ATS8500..... (Pistol Grip Handle)..... \$105.95

ATS8501..... (Straight Handle)..... \$110.95

HAND NIBBLER



Improved nibbler design provides maximum comfort and ease of use. The extra long handles (7") delivers enough force to easily cut through 18 ga. (.046") aluminum, steel, or plastic. The punch action of the nibbler makes it flexible enough to cut any shape ranging from a straight line down to a 5/16" radius circle.

64823..... \$20.95

ATS AIR NIBBLER



- Cuts up to 16 ga (.060" / 15 mm) steel or aluminum
- Easily replaceable punch and die
- Weight 1.74 lbs (.79 kg)

Cuts beautiful, burr-free edges in aluminum and steel sheets up to 16ga (.060") thick. Features push-type action to give you a better view of you cutting path.

ATS8300..... \$109.95

ATS8300-RP..... (Replacement Punch)..... \$14.95

JILSON SUPERSNIP® SHEARS



The SuperSnip cuts cleanly and accurately without damage to painted, plated, or polished surfaces! As it cuts, the SuperSnip conveniently snips off the waste curl so that it does not build up and interfere with your progress; and a built-in guard prevents the cut-off waste from flying up and into the eyes. The SuperSnip makes straight or curved cuts in up to 16 gauge aluminum or 18 gauge steel. Interior cuts can be made by first drilling a 1/4" hole.

J1451 \$55.95

JS1251RB..... (Replacement Blade) \$9.95

JILSON MONODEX® SHEARS



The Monodex® shears will accurately cut aluminum up to 16 gauge, and mild steel up to 18 gauge without distorting, or curling the edges of the cut. Interior cuts can easily be made by first drilling a 1/4" starter hole to accommodate the blade.

JS12 \$31.95

JS1251RB..... (Replacement Blade) \$9.95

RTN TUBING NOTCHER



The RTN100 (O' Joint Jigger) is a bench-mounted tubing notcher designed to make precision angular cuts in both round and rectangular tubing. By using inexpensive BIMETAL hole saws (not included), you can easily and economically notch all types of tubing ranging from mild aluminum to stainless steel.

RTN100..... \$175.95

RTN100B..... (Base Adapter) \$39.95



SHEET METAL TOOLS

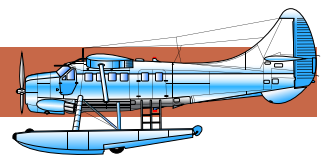

ATS BENCH BENDER BRAKE



Bends and forms up to 90° in metals up to 18 gauge thickness. Provides flanged edges up to 1" in height. Adjustments for stock thickness, sharpness of bends are easy to make. Includes two "C" clamps.

PART	CAPACITY	BENDING LENGTH	PRICE
144ST	18 ga.	18"	\$44.95
244ST	18 ga.	24"	\$55.95
364ST	18 ga.	36"	\$81.95

MITTLER BROS AIRCRAFT PUNCH AND FLARE SET

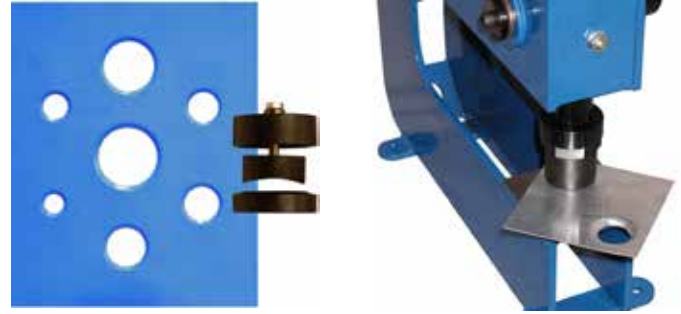

Mittler Brothers punch and flare tool sets are designed to give your sheet metal a unique, clean look. Just drill a pilot hole for the draw bolt and then apply the tool and tighten the bolt for a smooth, flared hole in one easy step. They can also be used as a hole punch, simply by using the punch and die. Can be used on aluminum with a thickness of 0.040 in. to 0.062 in., mild steel with a thickness of 0.040 in. to 0.062 in., and stainless steel with a 0.040 in. thickness.

LANCASTER PUMPS® METAL SHRINKER/ STRETCHER



Shrinks and stretches metal to form gentle radiuses bends or to straighten out sheet metal. Shrinks metal down to a 2" or 3" radius. Works and forms metal up to, and including, 16 gauge. Mounts easily in a bench vise. Jaws are reversible to increase usage.

PART	DESCRIPTION	PRICE
4135	Metal Shrinker	\$216.95
4136	Metal Stretcher	\$216.95
4135/4136	Set of Both Units (4135 & 4136)	\$405.95
523	Replacement Shrinker Jaws	\$108.95
524	Replacement Stretcher Jaws	\$108.95
4135-524	Shrinker Stretcher Combo Unit 1 Metal Shrinker & 1 Stretcher Jaw	\$295.95

PART NUMBER	SIZE	PRICE
1300-030AC35	1"	\$129.95
1300-031AC35	1 1/4"	\$129.95
1300-032AC35	1 1/2"	\$145.95
1300-033AC35	1 3/4"	\$145.95
1300-034AC35	2"	\$155.95
1300-035AC35	2 1/4"	\$155.95
1300-036AC35	2 1/2"	\$155.95
1300-037AC35	2 3/4"	\$169.95
1300-038AC35	3"	\$169.95
1300-039AC35	3 1/8"	\$229.95
1300-040AC35	3 1/4"	\$229.95
1300-041AC35	3 1/2"	\$229.95
1300-042AC35	3 3/4"	\$245.95
1300-043AC35	4"	\$245.95
1300-044AC35	5"	\$299.95
1300-045AC35	6"	\$355.95

PUNCH AND FLARE KITS		
PART NO	DESCRIPTION	PRICE
1300-415	6 Piece Kit in sizes: 1", 1-1/4", 1-1/2", 1-3/4", 2", and 2-1/2"	\$779.95
1300-412	7 Piece Kit in sizes: 1", 1-1/4", 1-1/2", 1-3/4", 2", 2-1/2", 3"	\$929.95
1300-414	9 Piece Kit in sizes: 1", 1-1/4", 1-1/2", 1-3/4", 2", 2-1/4", 2-1/2", 2-3/4", 3"	\$1,119.95
1300-413	13 piece kit in sizes: 1", 1-1/4", 1-1/2", 1-3/4", 2", 2-1/4", 2-1/2", 2-3/4", 3", 3-1/4", 3-1/2", 3-3/4", 4"	\$2,049.95

See complete listing of sheet metal tools online at www.aircraft-tool.com

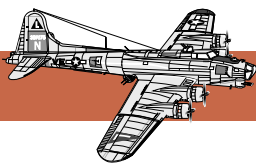

SHEET METAL TOOLS

JET™ COMBINATION SHEAR, BRAKE AND ROLL



This tool combines the functions of a shear, bender brake, and a slip roller in one compact unit. The Shear can be used with mild steel, aluminum, soft metals, and plastics. The Brake has removable fingers that permit angle, channel, box and other complex bending operations. The Slip Rolls are precision turned and ground with wire grooves.

PART	WIDTH IN.	WGT. (LBS)	MIN. ROLL DIA (INCHES)	CAPACITY	PRICE
SBR-30N	30	320	1-1/2	22ga. (.030)	\$1,249.95
SBR-40N	40	575	2	22ga. (.030)	\$1,949.95
SRS-30N	Optional 30" Floor Stand for SBR-30N				\$257.95
SRS-40N	Optional 40" Floor Stand for SBR-40N				\$336.95

JET™ HAND BENDER BRAKES



Jet Hand Brakes are constructed to last. All body sections are welded steel plate with heavy truss rods and braces for greater strength, a precise bed and beam alignment ensures accuracy. The HB-1648N features a removable apron nose extension.

PART	WIDTH IN.	WGT. (LBS)	FINGERS	CAPACITY	PRICE
HB-2248N	48	210	None	22ga. (.030)	\$919.95
S-48N	Optional Floor Stand				\$405.95

TENNSMITH BENDER BRAKES 4', 6', 8' & 10'



Tennsmith brakes are the industry standard. Their rugged construction and precise control makes them the most sought after tool on the market. Their ease of operation causes less fatigue and boost operations efficiency. FOB shipping point.

PART	WID IN.	WGT (LBS)	FINGERS	CAPACITY	PRICE
S48-22	48	220	None	22ga. (.030)	\$722.95
HBS48-16	48	460	None	16ga. (.060)	\$1,346.95
HB97-18*	97	1385	None	18ga. (.040)	\$3,931.95*
HB121-18*	121	2350	None	18ga. (.040)	\$5,678.95
U48-22	48	280	2",3",4"	22ga. (.030)	\$930.95
HBU48-16	48	495	2",3",4"	16ga. (.060)	\$1,523.95
HBU72-16*	72	1700	2",3",4"	16ga. (.060)	\$4,778.95
B48	Optional Stand (for use with S48, U48, & HBU48)				\$244.95

*Free-standing floor models

TENNSMITH INDUSTRIAL SHEARS



Unit is available in 36" or 52" length and comfortably handles up to 16 Ga. mild steel. Comes complete with protractor gauges, slide gauges. FOB shipping point.

PART	WIDTH	WEIGHT	PRICE
S-36	36"	700 lbs.	\$2,236.95
S-52	52"	950 lbs.	\$2,974.95

Visit www.aircraft-tool.com for full selection of Bender Brakes, Shears, and Slip Rollers.



PRECISION CABLE TENSIOMETER



optimanufacturing

The T60 is an industrial and military grade tensiometer accurate to within 5%. Simple, comfortable lever grip permits one hand operation without operator fatigue. A positive 3-point cable grip system prevents dislodgement when the instrument is hanging free on control cable. The accurate built-in gage eliminates guess work. It requires no risers for the various size cables. The gauge also has a "read hold" feature which allows you to take a reading in confined areas. Includes certificate of calibration conformance.

RANGE IN LBS.	CABLE SIZES	UNIT USED	ACCURACY
10-200	1/16", 3/32", 1/8"	C8	5%
30-200	5/32", 3/16"	C8 or C9	5%
80-200	7/32", 1/4"	C8 or C9	5%

T60-1001-C8 (10-200 lbs)..... **\$1,014.95**
T60-1001-C9 (150-450 lbs)..... **\$1,024.95**

COMPACT CABLE TENSIOMETER



optimanufacturing

The extremely small size of this tensiometer permits entry through small openings, and permits accurate readings on cables located in confined areas. Each instrument is calibrated at the factory and is provided with its own calibration chart for the simple conversion of readings into pounds of tension. The chart also indicates the risers that must be used to accommodate various sizes and tensions. This tool is so easy to use that the entire testing operation can be done with one hand in a matter of seconds.

RANGE IN LBS.	CABLE SIZES	RISER USED	ACCURACY
10-100	1/16", 3/32", 1/8"	Number 1	5%
15-150	5/32", 3/16"	Number 2C	5%
25-150	7/32", 1/4"	Number 3	5%

MC257 (Model Type T5-2002-101-00)..... **\$940.95**

FLYING WIRE TENSIO METER



A simple, elegant, and extremely accurate flying wire tensiometer that's designed to be used in conjunction with a standard dial or beam type torque wrench. This tool is used for setting the tension on flying wires from 1/4 - 1/2 inch, and tension ranges from 200 lbs to 2400 lbs. Can also be used for setting drag, anti-drag wire tension. Ideal for use on Stearmans, Wacos, and Pitts, etc. To use this tool you'll need a torque wrench with a 1/2" drive. Please note that a flying wire's size is measured at the round, threaded end of the wire, not across the flat. Tie wires are also measured by the thread size and pitch.

HWT-1 (Tensiometer Only) **\$260.95**
HWT-1KIT (Tensiometer & Dial Torque Wrench) **\$529.95**

ECONOMY CABLE TENSIO METERS



3375D

KM8159

This tool combines low cost with high quality and accuracy. It's a direct reading tensiometer that's compact enough to fit through inspection holes.

PART	RANGE IN LBS.	CABLE SIZES	PRICE
3375D	15-70	1/16", 3/32", 1/8"	\$229.95
3375G	50-350	5/32", 3/16"	\$251.95
3375H	50-350	1/4"	\$229.95
KM8159	Set of 3 Tensiometers plus storage case		\$679.95

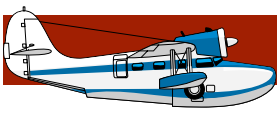

CABLE & WIRE

ATS SAFETY WIRE TWISTER



Reversible

Non-Reversible

"They work well so far and I haven't had any complaints with them. They work better than name brand safety wire pliers like Snap-On or Matco, believe it or not! I haven't had any issues using these on 0.041" safety wire, unlike other more expensive name brands. I'd highly recommend getting these if you need to safety wire a lot, like in the aviation industry."

Reversible Safety Wire Pliers switches from right-handed (clockwise) to left-handed (counterclockwise) twisting at the flick of a switch. This allows you to change directions on the fly without having to resort to a second tool. Excellent for series wiring where you must switch directions with each bolt. Features a smooth spring-loaded automatic return with a rugged reversing mechanism that resists dirt and contaminants, with a positive locking collar that will not pop back during use. It also has a tapered nose, and built in wire cutters. These are the twisters I want in my tool box!

6WR.....	(6" Reversible).....	\$79.95
9WR.....	(9" Reversible).....	\$79.95
6WA.....	(6" Non-Reversible).....	\$27.95
1WA.....	(10" Non-Reversible).....	\$25.95

TURNBUCKLE RIGGING KITS



"This product just about paid for its self with the first use, I use it on all aircraft cables that I work on" ~ K. Brown

Adjusting cable turnbuckles no longer has to be a dreaded ordeal, and you won't need three hands to do it. With our Turnbuckle Rigging Kit you'll get a complete solution that consists of our Turnbuckle Rigging Tool (TB01) to hold the terminal ends of the turnbuckle in place and keep the cable from twisting as you turn the barrel. And you also get our Turnbuckle Wrench (TB02) to make turning the barrel a piece of cake. The wrench clamps around the barrel (MS21251 style) and gives you the leverage to effortlessly turn it. This kit is a real timesaver that will let you adjust turnbuckles through inspection holes quickly and with minimum effort.

TB12K	(Rigging Kit).....	\$49.95
TB01	(Rigging Tool Only)	\$24.95
TB02	(Turnbuckle Wrench Only)...	\$29.95

HAND SAFETY WIRE TWISTER



The hand twister is a convenient way of twisting safety wire in very confined areas. The narrow shaft reaches into areas that are inaccessible to other safety wire tools.

134S.....	(8")	\$10.95
134SL	(12")	\$12.95

ATS EZ-TWIST SAFETY WIRE BIT



The EZ-TWIST safety wire twisting bit quickly snaps into any 1/4" bit holder (or chuck) for instant use. Simply string the safety wire through the bolt or nut to be wired and run the wire ends into the EZ-TWIST. Then, set your drill to forward (or reverse for left-handed twists), and twist away.

EZT3.....	(3")	\$7.95
EZT6.....	(6")	\$8.95

SAFETY WIRE



Stainless steel annealed, used to secure bolts, nuts or hardware subject to vibration. Comes in no waste 1 lb. dispenser cans. Type 302. MS-20995C; MIL-W-6713.

PART	DIAMETER	PRICE
302-21	.021	\$14.95
302-25	.025	\$14.95
302-32	.032	\$14.95
302-41	.041	\$14.95

For more information about our products, visit our website www.aircraft-tool.com.



MILBAR PROFESSIONAL SAFETY WIRE KIT

This versatile safety wiring kit belongs in every professional's tool kit. It includes three Safetytwist® wire twisters that will cover any application. The kit includes a 6" Mini Twister with tapered nose, a 9" Spring Return Twister, and the 13W specialty twister that is adjustable from 9" to 12". Also included are three 1/4 lb. spools of annealed stainless steel wire (.020", .032", .041"). It's all packed in a durable plastic carrying case. (NSN 5180-90-986-8939).



105W.....\$209.95

MILBAR REVERSIBLE SAFETY WIRE TWISTER



Milbar's safety wire twister pliers can twist safety wire in either direction with a simple turn of a sleeve - a second tool is not needed for left handed twisting. The jaw design holds the wire firmly without nicks or scrapes. It also features a spring-loaded return for easy operation in tight areas. Made in the U.S.A.

25W..... (6")\$95.95
26W..... (9")\$100.95

MILBAR SAFETY WIRE TWISTER



The Milbar right-hand safety wire twister has a diagonal nose for easier use in tight areas, and features an automatic spring return for faster operation. They are used throughout the aerospace industry as well as in the military. Made in the U.S.A.

11WS..... (6" Right Hand)\$79.95
1W393..... (9" Right Hand)\$79.95
5W4..... (9" Left Hand)\$100.95

MILBAR SAFETY WIRE SPECIALTY TWISTER



The Milbar Specialty Twister is ideal for difficult access situations. Its deep, slender reach will take it into areas that just cannot be reached with ordinary safety wire pliers. Adjustable 9" to 12", right hand twist with manual return.

13W.....\$55.95

ATS SAFETY WIRE DRILL JIG



This tool provides a fast and simple way to drill safety wire holes in the HEAD as well as the BODY of AN bolts, and studs. Works with all Hex Head, Allen Head, and Cap Head bolts from size 3/16" to 5/8." Includes holder, drill bushing (2), and 1/16" drill bits (2). Made from anodized 6061-T6 Aluminum for durability.

6061B.....\$59.95

CLAMPTITE™ PRO TOOL KIT



This tool is machined stainless steel with a one piece body, nose and bronze nut. This was designed for the detailed craftsman who need a long lasting tool able to hold up to extremely tough wire while clamping, binding and pulling the wire until the job is complete. For wire up to .080" diameter (our .062" diameter) or wire sizes .032" diameter, .041" diameter, .051" diameter, and .062" diameter.

CLTK01(Complete Kit).....\$129.95
CLT01(Tool Only).....\$69.95

SAFTBLOCKS



Special design enables you to drill safety wire holes through the head of bolts or through nuts, across the diagonal. Accepts up to 3/4 inch diameter nuts and bolts. Easy to use, just place the bolt head into the "V" groove, tighten the holding screw, drill and deburr.

MT002(Nut Saft Block)\$35.95
MT001(Aero Saft Block)\$42.95

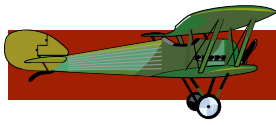

CABLE & WIRE

LOOS & CO. CABLE PRODUCTS

LOCOLOC® KEARNEY CABLE SWAGING MACHINE



This portable, hand operated roll type swaging machine will swage MS and AN type terminals onto galvanized and stainless steel cables from 1/16" diameter up to and including 3/16" diameter. You may purchase the tool only and get only the dies you need, or you can purchase the complete kit. The kit includes the machine, a full set of roll dies, terminal gauges, feed guide adapters, and a steel carrying and storage case.

LOCOLOC® CABLE SWAGER KIT



This kit contains everything you need to swag cable sizes from 1/16" up to 3/16". It has an assortment of oval and stop sleeves, AN steel thimbles, compression gauge, steel tool box, plus the 1 swager, and the C-7 cable cutter.

CSS-1 \$1,133.95

PART	DESCRIPTION	PRICE
M1-K	Complete kit which includes all of the items listed below. Shipping weight 64 lbs.	\$7,849.95
M1	Swaging machine only with case, Feed Guide Assembly, & Feed Guide Adapters	\$3,389.95
M1-B2	1/16" Ball Terminal Die	\$789.95
M1-B3	3/32" Ball Terminal Die	\$789.95
M1-B4	1/8" Ball Terminal Die	\$789.95
GAB24	Ball Terminal Gauge (1/16"-1/8" cable)	\$199.95
M1-S2	1/16" Straight Terminal Die	\$629.95
M1-S3	3/32" Straight Terminal Die	\$627.95
M1-S4	1/8" Straight Terminal Die	\$629.95
M1-S5	5/32" Straight Terminal Die	\$629.95
M1-S6	3/16" Straight Terminal Die	\$629.95
GAS26	Straight Terminal Gauge (1/16"-3/16" cable)	\$210.95

HAND SWAGER



Multi-compression hand swager with cable cutter. Swages 1/16", 3/32", 1/8", 5/32", and 3/16" oval and stop sleeves, plus 7/32" stop sleeves, total of 11 sizes plus the ability to cut up to 7/32" diameter aircraft quality steel cable (1SC only). A tool with a dozen functions! Only 26" long. Shipping weight 6.5 lbs.

1SC (LOOS & CO. LOCOLOC® Model) \$326.95

BENCH SWAGER



For in-shop one location jobs. Multi compression jaws swag 1/16", 3/32", 1/8", 5/32" and 3/16" oval and stop sleeves plus 7/32" stop sleeves. 22.5" long, 6.25" high.

1BSC (LOOS & CO. LOCOLOC® Model) \$531.95

CABLE DIAMETER GAUGE

Quickly and accurately measures standard cable diameters. Measures sizes: 1/16", 3/32", 1/8", 5/32", 3/16", 7/32", 1/4", 9/32", 5/16", 3/8".



GAP4 \$6.95

CABLE & WIRE

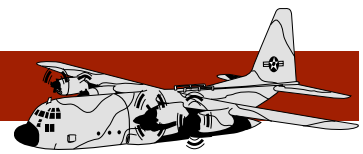

CABLE SWAGERS



Compound action swagers doubles the force so that you can make perfect swages with less effort. Each swager features a built-in cable cutter that will cut up to 1/4" cables. Swages standard AN copper, zinc, and steel oval and stop sleeves. Not for stainless steel sleeves.

PART	CABLE SIZES	WGT	LEN	PRICE
JPS14	1/16", 3/32", 1/8"	3 lbs	14"	\$49.95
JPS24	1/16", 3/32", 1/8", 5/32", 3/16"	6 lbs	24"	\$85.95

FELCO® DELUXE CABLE CUTTERS



Swiss made cutters feature a unique triangular jaw that cuts cleanly and never frays the end. New handle design allows you to cut with less effort. 3/16" capacity.

- C7 (Felco® Brand) \$73.95
- O690TN (Cooper Tools® Brand) \$41.95
- E200-063 (Eclipse) \$17.95

AN100 THIMBLES, OVAL & STOP SLEEVES

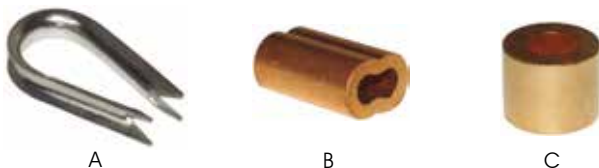

Thimbles are made of stainless steel. Oval and Stop sleeves are made of copper. Note: The C4 is used for both 3/32" & 1/8" cables.

THIMBLES (A)			OVAL SLEEVES (B)			STOP SLEEVES (C)		
PART	SIZE	PRICE	PART	SIZE	PRICE	PART	SIZE	PRICE
C3	1/16	0.54	SL-2	1/16	0.37	ST-2	1/16	0.53
*C4	3/32	*0.63	SL-3	3/32	0.58	ST-3	3/32	0.63
*C4	1/8	*0.63	SL-4	1/8	0.85	ST-4	1/8	0.63
C5	5/32	0.86	SL-5	5/32	1.25	ST-5	5/32	0.89
C6	3/16	0.99	SL-6	3/16	2.95	ST-6	3/16	0.89

HAND SWAGER



Ideal for quick swaging of nicopress sleeves onto cables. The 2 swager will do 1/16", 3/32", and 1/8" cables. The #3 swager is for 1/8", 5/32", 3/16" and 1/4" cables. A Go-No-Go Gauge is included with both the 2SKT and the #2 swager.

- 2SKT(Complete Kit with thimbles and Sleeves)..... \$34.95
- 2.....(For 1/16", 3/32" & 1/8" Cable)..... \$17.95
- 3.....(For 1/8", 5/32", 3/16" & 1/4" Cable)..... \$53.95
- 54-11(Go-No-Go Gage)..... \$5.95

HAND SWAGING TOOL



This is a (4) cavity tool, swaging sleeve sizes 1/32", 3/64" and 1/16" copper and aluminum sleeves, and 3/32" copper sleeves plus 1/32" stainless steel sleeves. Ratchet mechanism will not release until swage is complete.

- 13SBHS \$171.95

SWAGER GAUGE

Checks your cable swages to see if they meet acceptable standards. Measures sizes: 1/32", 3/64", 1/16", 3/32", 1/8", 5/32" and 3/16".



- GATP \$15.95

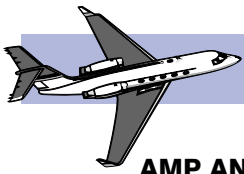

ELECTRICAL

AMP AND MOLEX PIN EXTRACTORS



The five piece Pin Remover Set is designed for use with various connectors such as MOLEX, AMP, TYCO, etc. The pin extractors come in various diameters. Simply, put the pin extractor into the housing, push the plunger of the pin extractor, and extract the pin – it's that easy. Pouch bag included.

CE-0275 \$66.95

PRECISION TWEEZERS



Surgical stainless steel, ideal for picking up and holding small parts.

E900-204..... (Set of 4) \$10.95

D-SUB INSERTION/EXTRACTION TOOL



Handy tool for installing and removing pins from D-Subminiature housings. Simply place over pin, press lightly and pull pin out.

E900-065..... \$4.95

CLOSED BARREL D-SUB CRIMPER



Ratcheting, 4-indent, spring-loaded crimper used to install machined terminal pins in D-Subminiature connectors. Installs AWG 20 to AWG 26 wires. Standard plugs 6 and 8 position.

E300-015..... \$34.95

PRECISION ELECTRICAL PLIERS

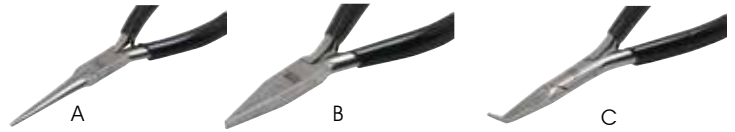

Excellent quality pliers for delicate work on electronic circuits and wiring. Drop forged from high grade steel with mirror polished surface, oil hardened and tempered. Easy open double leaf springs.

PART	FIG.	SIZE	TYPE	PRICE
E100-012	a	6"	Slim needle-nose	\$15.95
E100-013	a	5.5"	Needle nose	\$16.95
E100-015	b	5.5"	Flat nose	\$16.95
E100-014	c	5.5"	Bent nose	\$16.95

PRECISION ELECTRICAL CUTTERS



Manufactured from high grade steel with mirror polished surface, induction hardened cutting edges with hot-formed box joints.

PART	FIG.	SIZE	TYPE	PRICE
E200-057	a	4.5"	Full-flush diag cutters	\$17.95
E200-058	b	4.5"	Slim full-flush cutters	\$17.95
E200-059	c	5"	Full-flush side cutters	\$18.95
E200-060	d	5"	Oblique end nippers	\$20.95

STAINLESS STEEL PLIERS



These pliers are stainless steel with mirror polished finish that prevents flaking and corrosion. The leaf springs are spot welded to the tool handles to fix the jaws in a comfortable position. The forged box joint construction gives strength and precision

E100-006..... (7.5" Long-Nose Pliers) \$12.95

E100-025..... (5.3" Long-Nose Pliers)..... \$12.95

E100-017..... (6" Serrated Needle-Nose Pliers) \$16.95

E200-067..... (5" Side Cutting Pliers)..... \$13.95

INSULATED FORCEPS

- Hemostat locking design
- Surgical Stainless Steel
- Insulated handles
- Serrated jaws
- 6" OAL



E900-181..... (Straight) \$9.95

E900-222..... (Curved) \$10.95



TYPE	DESCRIPTION	FIG
A	Insulated Terminals & Splices: 22-10 AWG red, blue and yellow terminals and splices.	
B	Coax Terminals: BNC, TNC, Mini-UHF, RG-58, 141, 142, 303, 400, 59, 62, 210, RG6, 212, 222, 304, Belden 8279, 8281, 9231, 9141.	
C	Open Barrel Contacts: 30-20 AWG pins and sockets found in most AMP, MOLEX, ITT, Cannon, and other connector plugs.	

TERMINAL CRIMPER DIES

These replacement dies will fit into the Professional Ergonomic Crimpers (E902 series), as well as the Economy Ratchet Crimpers (E300 series). Each die is drop forged from tool steel and hardened.



E300-058	(Type A)	\$16.95
E300-038	(Type B)	\$16.95
E300-039	(Type C)	\$16.95

See complete selection of dies online at www.aircraft-tool.com

ECONOMY RATCHET CRIMPERS



Powerful full-ratcheting crimper with safety release and adjustable crimp pressure. Very comfortable rubber handles and ergonomic design makes it easy to install multiple terminals without fatigue.

E300-002	Insulated Terminals (Type A)	\$37.95
E300-003	BNC Terminals (Type B)	\$37.95
E300-005	Open Barrel Terminals (Type C)	\$37.95
E300-054	(Frame Only)	\$29.95

PROFESSIONAL ERGONOMIC CRIMPER



Full-ratcheting crimper with an ergonomic angled shape that reduces the exertion required to crimp terminals by as much as 60%. Has an adjustable crimp pressure control wheel with safety release, and a comfortable rubber handles will not slip or stress your hand.

E902-152	Insulated Terminals (Type A)	\$41.95
E902-137	BNC Terminals (Type B)	\$41.95
E902-138	Open Barrel Terminals (Type C)	\$41.95
E902-085	(Frame Only)	\$31.95

ELECTRICAL TERMINAL CRIMP KIT

Now with Aviation Grade Terminals



- Heavy duty ratcheting crimper with rubber handles (E300-002)
- 10 Butt splices 18-22 AWG
- 8 Butt splices 14-16 AWG
- 6 Butt splices 10-12 AWG
- 32 Ring terminals #4, #6, #8, #10 1/4, 5/16 10-15 AWG (Yellow)
- 24 Ring terminals #6, #8, #10, 1/4 14-16 AWG (Blue)
- 16 Ring terminals #8, #10, #10 18-22 AWG (Red)

An electrical terminal kit that includes a heavy-duty ratcheting crimper (Type A) with rubber comfort grips, plus an assortment of aviation grade insulated terminals and splices. Crimper features an adjusting wheel to control pressure. Terminals meet MS-25036 QPL Class 1, and SAE AS7928, Type II, Class 1 and 2 standards

AVT500K	(MilSpec/AS Aviation Grade Kit)	\$89.95
E500-037	(Standard Kit)	\$60.95

ELECTRONIC MAINTENANCE FIELD KIT



A complete field maintenance kit for on-the-spot electrical repairs. Includes all of the most commonly used electrical maintenance tools for testing and repair. The entire kit comes in a convenient zippered canvas pouch for easy storage and transportation.

- 7 Pc Hex Key Set
 - 5" Side Cutters
 - 6" Combination Pliers
 - 6" Long nose Pliers
 - Desoldering Pump
 - Soldering Iron, Stand & Solder
 - PVC Electrician's Tape
 - Digital Multimeter
 - 8 Pc Screwdriver Set
 - (3 Phillips, 3 Flat, 2 Nutdrivers)
 - Zippered carrying case
- | | |
|-----------------------|-----------------|
| E500-032 | \$104.95 |
|-----------------------|-----------------|

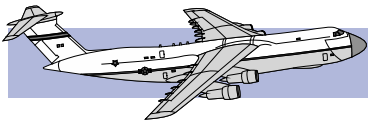

ELECTRICAL

HEAVY GAUGE RATCHETING CRIMPER



Powerful ratcheting crimper makes short work of attaching terminals to heavy gauge wires and cables in sizes AWG 12-10, 8, 6, and 4. Features new generation of energy saving crimper designed and high leverage handles to provide superior mechanical advantage.

CP-351B \$62.95

NON-INSULATED TERMINALS RATCHETING CRIMPER



- Non-insulated spade/ring terminals
- JIS 1.2, 2.0, 3.5 5.5 mm²
- AWG 22-16, 16-14, 12, 10
- DIN 1.5, 2.5, 4.0, 6.0 mm²

This non-slip energy saving Ratcheting Crimper is made of high quality carbon steel with black oxide finish for anti-rust. The high leverage handles and compound action mechanism provide a superior mechanical advantage compared to the generic crimper.

CP-151B \$34.95

LUG TERMINAL CRIMPER



All metal tool, for crimping terminals to heavy gauge wires from size AWG8 to 250MCM. Adjustable depth knob controls the amount of crimping. Includes built-in go-no-go gauge. 22" Overall length.

E300-107 \$136.95

MILBAR® MULTI-PURPOSE ELECTRICAL CRIMPER



The Multi-Purpose Crimper will crimp open barrel, closed barrel, or flag terminals. It also has a bolt cutter section to cut bolt sizes: 4-40, 6-32, 8-32, 10-32 & 10-24.

25E (Milbar) \$62.95

CP-413G (Eclipse Stripper/Crimper) \$10.95

AUTOMATIC WIRE STRIPPER AWG 24-10



- Insulated terminals 22-10 AWG
- Non-insulated terminals 22-10 AWG
- Auto ignition terminals
- Built-in cutter
- Adjustable stopper
- Micro adjustment
- Strips AWG 24-10
- Crimps lugs and terminals

This automatic wire stripper is an excellent multi-use tool. It will strip 24-10 AWG copper wire, crimp insulated and non-insulated terminals and lugs, and features a built-in cutter.

E200-072 \$18.95

CRIMPER - NON-INSULATED TERMINALS AWG 22-6



- For solderless, non-insulated terminals
- AWG 22-16, 16-14, 12-10, 8, 6
- Ratcheting design with quick release
- High leverage handle requires minimal force

These high leverage crimpers are designed to work on non-insulated ring and spade terminals. The long arms require minimal force to make a strong crimp on your connectors. The ratcheting design ensures a proper crimp is made every time. The tool features a quick release if you need to abort your crimp mid-termination.

E300-055 \$39.95

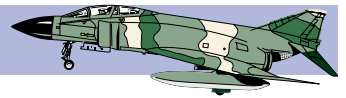

AUTOMATIC WIRE STRIPPER

Classic style wire stripper cleanly removes insulation from wires in sizes AWG-22, 16, 14, 12, 10 and 8. Constructed of Die Cast Aluminum for durability.



E200-003.....\$17.95

MULTI-FUNCTION WIRE STRIPPER/CRIMPER

Self-adjusting wire stripper safely removes insulation from AWG 24 to 10 wires. Crimper section installs insulated and non-insulated terminals from AWG 22 to 10 Steel construction.



E200-070.....\$24.95

4-WAY INDENT DEUTSCH TERMINAL CRIMPER



This economical Crimp Tool delivers the same type of crimp as the more expensive MIL-Spec tools at a fraction of the cost! At only 6 1/2" long, this tool maintains a full cycle ratchet that insures a complete and perfect crimp each and every time. Use with 12-20 AWG closed barrel terminals.

E902-499.....\$34.95

9.5" CRIMPER PLIERS



This multi-functional tool is ideal for those working with un-insulated terminals. Used for both cutting and crimping solid or stranded wire. Constructed of hard steel for long lasting durability.

E100-039.....\$14.95

COAX CABLE STRIPPER

Twin blade design safely removes the outer and inner insulation from coaxial cables. Just clip it onto the cable, and give it a couple of spins to prepare the coax for a BNC connector. Works with RG-58/59/62/and 6 cables.



E200-004.....\$14.95

WIRE STRIPPER/CUTTER

At only 6" long, this wire stripper/cutter fits the hand very comfortably. The cutting jaws easily cut up to 14 AWG copper wire. At the other end is an automatic stripper that cuts and removes insulation from 26 AWG to 14 AWG wire.



ELB250.....\$10.95

FOD CATCHING NIPPERS

Heavy duty nippers with wire catching clip to trap snipped wire ends before they can fly off and cause damage.



2178M..... (Xcelite® Brand, USA)\$18.95

E200-082.....(Heavy Duty ESD Safe).....\$10.95

5" PRECISION FLUSH CUTTER



The Eclipse 5" Precision Cutter has micro tips and good for precision work. It's perfect for copper applications in small areas.

E200-002.....(14 AWG).....\$8.95

E200-071.....(16 AWG).....\$6.95

HEAVY DUTY LINE MANS PLIERS



Heavy duty Lineman's pliers are made from high quality carbon steel, hardened finish. The product features tapered head allows easy work in narrow space, coil spring for self-opening action to supply smooth operation, plastic coated handles for comfortable use.

E902-307.....\$22.95

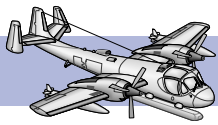

ELECTRICAL

GAS AUTO IGNITE SOLDERING IRON

The perfect addition to your toolbox! A soldering iron with auto ignition for easy starting and operation under any condition. The transparent nylon gas tank shows you your fuel level at a glance. And the heating element is ceramic for a long service life. Refills easily from any butane dispenser. Comes complete with accessories and plastic case.



GS-23K \$68.95

BUTANE SOLDERING IRON

The world's most popular pocket-sized butane soldering iron specifically designed for the hobby/DIY enthusiast. Features include: soldering temperature of 410-750°F, torch temperature 2400°F, 5.5" OAL and ready to use 20 seconds after ignition. Kit includes: Soldering Iron, conical tip 7992, protective cap with igniter instructions. Does not include butane fuel.



7971 \$27.95

DUAL WATT SOLDERING IRON 15-30W



The high-quality tip of this Soldering Iron is built for a long lifespan of use. The iron features a soft-grip ergonomic handle and a three position switch on the handle to easily switch between off, 15W, and 30 Watt settings. Suitable for lead-free soldering for RoHS.

E902-512 \$19.95

AUTO IGNITION GAS SOLDERING IRON



This professional soldering iron and gas torch features an easy to use auto ignitor and a precision control system for accurate heat delivery. The built in stand keeps the tool and workspace safe when not in use. It includes a needle soldering tip for precise electrical work, as well as a torch for use with shrink tubing and brazing.

GS-210 \$50.95

ESD SAFE SOLDERING STATION



The stabilized precise temperature control of this station makes it ideal for use with delicate circuitry without danger of overheating. It is also ESD (Electro-Static Discharge) certified, which means that it will protect sensitive circuits from static discharge (the leading cause of bench-level circuit failure) while you're working on the part.

SS-207E (Digital Display) \$104.95
SS-206E (Analog Display) \$79.95

QUICK CHARGE CORDLESS SOLDERING IRON KIT

The Quick Charge Soldering Iron is a rechargeable soldering iron kit. It's ideal for the shop or field mechanic who needs a reliable and consistent soldering tool when making critical electrical repairs. It has a power rating of 25 watts and reaches 900°F in less than ten seconds. The complete kit includes: rechargeable soldering iron, charging stand, a fine tip, a heavy-duty tip, battery and instructions.



7700 \$55.95

WELLER® PRO CORDLESS SOLDERING IRON



- 950 °F heat in under 15 seconds
- 150 solder joints per battery set
- White LED illumination light
- Includes batteries, lead free solder, 2 tips, and wrench set

Portable battery operated soldering iron is perfect for field maintenance work.

BP865MP (Soldering Iron) \$24.95
BP10 (Replacement Tip) \$11.95

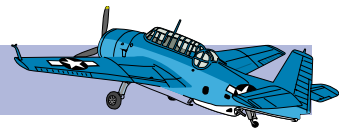

3PC SOLDERING SPONGES



A good sponge is just as important as having a good quality iron. Keep your tips clean. The Eclipse 902-335 is a package of 3 sponges that can be cut to any size for use in soldering stands.

E902-335.....\$18.95

PRYING/SPUDGER TOOL ASSORTMENT



This set contains 5 tools for opening and prying small electronic components without damaging the housing or parts. Use the prying paddle and opening levers to prevent scratching or chipping the housing. The aid tool is made of reinforced nylon and is handy heat resistant tool. Ideal for catching and bending small wires or opening cases.

1PK-3179.....\$9.95

LIQUID DISPENSER



Polyethylene liquid dispenser bottle feature a unique pump mechanism that prevents back wash of containments into the container. Ideal for dispensing solvents and cleaning solutions. Plastic bottle is chemically inert and will not react with or contaminate contents.

E900-251..... (4 oz).....\$6.95
 E900-252..... (6 oz).....\$7.95
 E900-253..... (8 oz).....\$8.95

ACID BRUSH SET



High Quality Horse Hair acid brushes are great for applying and removing soldering flux, applying solvents and adhesives, etc. No shop should be without a set of these handy brushes. Overall length of 5-3/4", which gives you the ability to get into tight spaces easily. 5 per pack.

BA01.....\$1.50

SOLDERING HELPING HANDS



SN-396



SN-390

Includes 16 super bright and energy saving LEDs . The magnifier is on a flexible neck that gives you 2.5X(6D) and 4X(12D) magnification. The 3 adjustable helping hands clips allow for precise positioning and secure grip on your work. The magnifier is powered by either 4 AA batteries or external power adapter. The set includes solder spool brackets, soldering iron holder, cleaning sponge, brass tip cleaner and solder flux.

SN-396 (With LED)\$34.95
 SN-390(Economy).....\$8.95

DESOLDERING TOOL

Great for electrical repair work where wires or components must be removed and resoldered. One-shot vacuum action cleanly removes excess solder from the work area.



E900-001N\$6.95

DESOLDERING PUMP



This mini desoldering pump is small enough to operate with one hand. It delivers a precise vacuum to remove molten solder from circuit boards.

DP-366J..... (Mini)\$4.95

6PC SOLDERING AID SET



Tool-Tips:

- Chip
- Holder
- Lever
- Fork Shaft
- Scraper
- Needle
- Hook
- Knife
- Brush

The set consists of 6 double-ended tools with pick and brush tips. This kit is specially designed to aid you in protecting your heat sensitive components during soldering.

E900-100.....\$7.95

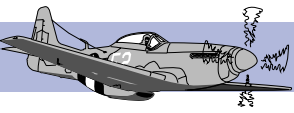

WIRE HARNESS SPOON



No avionics installer should be without this tool. This handy tool makes the job of inserting a new wire into an already tied off wire bundle much easier. This tool is a great time saver.

M35250.....\$9.95

DIAMOND GRIP TERMINAL CLEANER



These patent-pending IPA 3-piece terminal cleaners feature a highly durable and abrasive coating for cleaning small spade pin electrical connectors. They work on both male and female connectors for flat pin or spade-style terminals to remove corrosion and extend harness life. The base of the handles features a bonus abrasive coating for general large-contact maintenance. All three cleaners are stored in their own premium-quality holster with a magnetic clasp.

8040.....\$29.95

CANNON PLUG PLIERS



It is a pliers that I have needed for decades and did not know it. It is very light and opens tight joints without marring the surface. ~ R. Pendergast

Designed to safely install and remove Cannon plug collars. Incorporates removable plastic inserts which will grip on smooth, oily or serrated surfaces. Adjustable from 3/4" to 2-1/2" grip diameter.

AT508K (ATI Brand).....\$29.95

AT508K-RP..... (Replacement Jaws for AT508K)\$9.95

52910N (Crescent® Brand)\$36.95

DOUBLE HEMOSTAT SET



Jaws open greater distance than handle for added reach in tight locations. Increases access by up to 50 percent. Variable locking positions. Set includes straight and 45 degree pliers.

82111.....\$69.95

HOLLOW SHAFT NUT DRIVER



Bondhus Hollow Shaft Nut Drivers have a hexagonal upper shaft for use with a wrench for increased torque. They are made with a non-slip grip, anti-roll handle with an ergonomic design and a high strength, chrome plated shaft.

Includes sizes 3/16, 1/4, 5/16, 11/32, 3/8, 7/16, and 1/2-inch.

48445.....\$25.95

SPRING HOOKS



This tool is equipped with both a spring hook and pull tool making it ideal for pushing or pulling small springs and wires.

E902-070.....\$4.95

E902-073.....\$4.95

OVERHEAD LIGHT REMOVAL TOOL (WEMAC)

- Works on Beechcraft, Cessna, Embraer, Sino Swearingen, and more
- No more damage to the housing when removing
- Manufactured with high friction elastomer tip for maximum grip
- 3-5/8" (9.2cm) high by 2-1/8" (5.4cm) diameter

A great tool to quickly and safely remove WEMAC overhead (eye-ball) cabin light and air vent housings for servicing.

WEMAC-1\$35.95





3M WIRE MARKER TAPE WITH DISPENSER

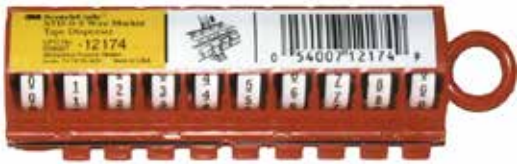

A convenient method for marking wire, cable, and terminals. Tape has numbers from 0 thru 9. Self adhesive, oil and solvent resistant.

233A2 \$62.95

WIRE MARKING TOOL



Bogert Aviation's Wire Marking Tool takes the guess work out of wiring jobs. Add a colored stripe to insulated 24-8 gauge wire for quick identification using the non-conductive nylon tool and a permanent marker. Aircraft wire, Romex, Cat 5, coax and data transmission cable are cleanly and easily identified by using different colored standard Sharpie markers. No batteries or specialty supplies needed.

BO-40M-WMT \$47.95

SEAL ALL TERMINAL RELEASE TOOL



A must have tool for working with Seal-All shells and terminals. Designed to depress Seal-All retention barbs to allow terminal removal from shells.

WHTSATRT \$9.95

32 PIECE ELECTRONICS REPAIR KIT



A complete 32-piece precision tech kit for electronics repair. Includes a wide variety of Torx, Torx Security, Phillips, Slotted, Hex and Pentalobe bits for repairing most electrical components. Tool kit comes with a heavy duty storage and carrying case with a locking slide.

GT661 \$27.95

3 1/2 DIGITAL MULTIMETER



The Eclipse MT-1233D digital 3-1/2 multimeter is perfect for students, and professionals alike because of its user interface and size. This palm sized device has functions such as a backlight, data hold, low battery indication, and overload protection indication. The MT-1233D complies with the newest CE safety standard.

MT-1233D \$16.95

DIGITAL MULTIMETER



This rugged multimeter is designed to give reliable, accurate readings under the most extreme conditions. Measures voltage, amperage, resistance, continuity, capacitance, temperature, frequency, and diode checks. Positive stop rotary switch selects any of over 40 different functions. 1 year warranty.

MT-1280 (Heavy Duty) \$41.95

MT-1232 (Economy) \$44.95

ANALOG MULTIMETER



The MT-2017 analog meter is perfect for field maintenance and complies with 2008 CE safety standards. It has a mirrored aluminum dial plate for easy reading, and can be used for resistance, current, and voltage measurements. The MT-2017 has a 20kOhm/V DC and 9kOhm/V AC input sensitivity. This zero center meter also features a continuity buzzer, battery test, and transistor hFE test.

MT-2017 \$31.95

DUAL DISPLAY MULTIMETER W/USB INTERFACE



The Pro Digital Multimeter with USB connector features a touch pad instead of the traditional mechanical knobs. With a large LCD screen and easy operation this unit is perfect for measuring AC/DC voltage and AC/DC current. Additional functions include current, resistance, capacitance, frequency, temperature measurements. It also includes an on-board diode tester to quickly test transistor and diodes. This unit also includes a USB port to connect to a computer for data logging purposes.

MT-1860 \$100.95

ELECTRICAL

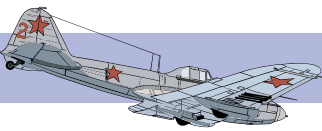

BATTERYMINDER® AVIATION BATTERY CHARGER/MAINTAINERS



Rated #1 by Aviation Consumer Magazine, the BatteryMINDER® Charger/Maintainer/Desulphator-Conditioner uses the latest in microprocessor controlled algorithms, coupled with several patented desulphation-recovery circuits to fully charge, maintain and condition all type/size/brands of lead-acid batteries -- including those by Concorde, Gill, and EnerSys.

- Fully automatic 3 stage charging
- Patented random sweep desulphation
- Polarity reversal indicator
- Short circuit and reverse polarity
- Auto-reset thermal breaker
- Rejects damaged battery
- Spark-proof
- Optima/AGM/Lower Temp. Mode
- Built-in battery condition indicators
- Automatic temp comp.

PART	VOLT	AMPS	DESCRIPTION	PRICE
128CEC1-AA-S2 244CEC1-AA-S2	12 24	2/4/8 2/4/8	For use with Gill/ non-LT/7000 series	\$241.95 \$241.95
128CEC1-AA-S3 244CEC1-AA-S3	12 24	2/4/8 2/4/8	Gil LT/7000 series, Odyssey, and Hawker	\$241.95 \$241.95
128CEC1-AA-S5 244CEC1-AA-S5	12 24	2/4/8 2/4/8	ALL Concorde 12V Aviation AGM (Absorbed Glass Mat) batteries	\$241.95 \$241.95

POWER UNIT/BATTERY CHARGER



Designed to supply filtered DC bus power through standard APU receptacle in private and commercial aircraft. Up to 25 or 50 amp is available for operating avionics and flight control systems when the master switch is activated. Can also charge the battery through the plug at a 10 amp rate. Output is current and voltage limited for added safety. DC current and voltage are displayed on panel meters.

PART	DC AMPS	DC VOLTS	AC POWER	PRICE
APU14V/25A	25	12	117V 60HZ 3 AMPS	\$678.95
APU28V/25A	25	24	117V 60HZ 6 AMPS	\$762.95
APU28V/50A	50	24	117V 60HZ 12 AMPS	\$896.95

SCHAUER® AVIATION BATTERY CHARGERS



Schauer's intelligent charger design follows the battery impedance to the end of the charge cycle for all battery types, thus ensuring a full charge with virtually no danger of overcharging or cooking the battery.

- Charge control: constant current charge to a constant voltage, then float standby.
- Fully automatic 3 stage charger can be left on the battery in maintaining mode.
- For any type lead-acid battery, including conventional, maintenance free, deep cycle, gelled-type, valve regulated batteries.
- Finishing voltage: 2.28V per cell float; 2.4V per cell finishing.
- Will start charging a deeply discharged battery with less than 4 volts.
- Current limiting, and short circuit proof
- Reverse polarity protection (except 2 amp models).

PART	AMPS	VOLTS	FEATURES	PRICE
JAC0212 JAC0512	2 5	12 12	With Battery Clips With Ring Terminals	\$31.95 \$83.95
JAC0224 JAC0524	2 5	24 24	With Battery Clips With Ring Terminals	\$31.95 \$83.95

PLUG AND JUMP GROUND POWER PLUG



The Plug and Jump is a very light weight portable unit. It can be used to start your aircraft using standard jumper cables and a car. The Plug and Jump comes in two models; The Universal Model for Cessna, Beechcraft, etc. (3 pin plug) and the single pin model for the Piper. It is not a battery in itself, but a simple conduit of power from any external power source to the aircraft. The Plug and Jump can be used for either 28 or 14 V systems.

- 11807**..... (3 Pin Unit - Cessna) **\$81.95**
- 11808**.....(Single Pin Unit - Piper)..... **\$100.95**





SCHAUER® AVIATION BATTERY CHARGER/GROUND POWER UNITS

JAC2024H-1



JAC2512-3

Schauer's battery charger/GPU features computer-controlled battery charging.

- Charge control: constant current charge to a constant voltage, then float standby.
- Fully automatic 3 stage charger can be left on the battery in maintaining mode.
- Can be set for any type lead acid battery, including conventional, maintenance free, deep cycle, gelled-type, valve regulated batteries.
- Cyclic voltage: FLOODED 2.5 volts/cell; GEL & AGM 2.4 volts/cell. 2.6 volts/cell for 36 & 48 volt batteries. May be preset to customer's specification for battery type.
- Will start charging a deeply discharged battery with less than 4 volts.
- Current limiting, Reverse polarity, and short circuit proof.

PART	VOLT	AMPS	DESCRIPTION	PRICE
JAC2512-1	12	25	Charger/GPU with Single Pin	\$235.95
JAC2024H-1	24	20		\$279.95
JAC2512-3	12	25	Charger/GPU with 3-Pin	\$279.95
JAC2024H-3	24	20		\$355.95

3 WAY BATTERY TOOL



Cleans and Removes Corrosion on Battery Posts and Terminals. Tapered reamer cleans and shapes terminal clamps. Positive and negative post cleaners are sized to fit battery posts.

11550.....\$9.95

BATTERY TERMINAL TOOL



This unique tool is designed to provide positive tightening of battery terminals on popular brands of lead/acid aircraft batteries without over-torquing and without the danger of an electrical short. The tool is made from steel for rugged service and is fully insulated with a rubber hand grip for protection against electrical shorts.

BO-11M-BTT\$22.95

BATTERY TERMINAL SOCKET

This patented socket design by an A&P mechanic solves the problem of battery terminal damage once and for all. This remarkable tool removes and installs terminals effortlessly and without damage to the nuts or posts. A torque-limiting feature makes it less likely to strip it or snap the stud. Uses any socket or box end wrench.



AGE01\$16.95

BATTERY TERMINAL & WIPER ARM PULLER



- Tips are made from strong heat-treated steel
- For most popular clamp sizes
- Tapered tips provide range and squeezing the handles expands the tips to cover many clamp sizes

Dual use pliers spread battery post clamps and tapered, ribbed tips remove corrosion and build-up from inside the clamp. Tips are made from strong heat-treated steel.

55410.....\$16.95

IMPERIAL® BATTERY CABLE CUTTER

A powerful set of cutters specifically designed to cut through copper battery cables. Easily cuts through cables as thick as 2/0 gauge. Cushioned grips for comfort. Not for use on steel cables.



BS103\$19.95

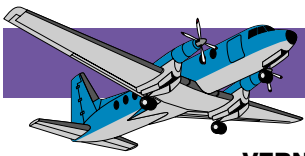

PRECISION MEASURING

VERNIER CALIPERS



52-058-008

52-057-004

- Fine quality vernier calipers are constructed of stainless steel.
- 52-057-004 offers 3-way measurement to .001" accuracy.
- 52-058-XXX series offers 4-way measurement in both inch and metric.

PART	RANGE	GRAD	FEATURE	PRICE
52-057-004	0-4"	.001"	Pocket caliper	\$54.95
52-058-008	0-8"	.001"/.02mm	Fine adjusting	\$75.95
52-058-012	0-12"	.001"/.02mm	Fine adjusting	\$115.95

ECONOMY DEPTH MICROMETERS



- Satin chrome finish
- .001" Graduations
- 4" wide base
- Base surface hardened, ground and lapped
- Ratchet thimble
- Locking clamp
- Includes wooden case.

PART	RANGE	GRAD	PRICE
52-225-114	0-4"	.001"	\$145.95
52-225-116	0-6"	.001"	\$184.95

SHOCKPROOF DIAL CALIPERS WITH THUMBROLL!

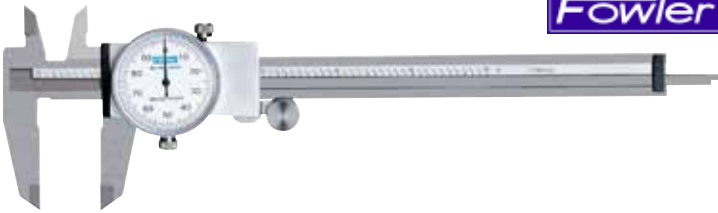

- 0.100" range per revolution
- Stainless steel construction
- Silky smooth movement
- Resolution to 0.001"
- 4-way measuring jaws
- Supplied in molded case

PART	RANGE	GRAD	DIAL FACE	PRICE
52-008-706	0-6"	.001"	White	\$79.95
52-008-707	0-6"	.001"	Black	\$79.95

More options available online at www.aircraft-tool.com

ECONOMY OUTSIDE MICROMETERS



- .0001" reading
- Carbide tipped anvils
- Ratchet thimble and locking nut
- Microfine graduations
- Includes standards on sets and sizes over 1"
- Also includes wrench and fitted case



PART	RANGE	GRAD	PRICE
52-229-201	0-1"	.0001"	\$79.95
52-229-202	1-2"	.0001"	\$77.95
52-229-203	2-3"	.0001"	\$75.95
52-229-213	0-3" set of 3 micrometers plus case		\$219.95

6" ECONOMY DIAL CALIPER



The rugged, 6" Dial Caliper is made from hardened stainless steel for the utmost in accuracy and durability. The large, clear dial accurately reads to .001 and has an adjustable bevel for zero setting. The body of the caliper features a satin chrome scale with etched graduations, and a covered rack prevents dirt and chips from entering the gear mechanism. There is also an adjustable stop rod for taking depth measurements.

GT107\$47.95

UTILITY MICROMETER



The satin chrome barrel and thimble offer easy to read etched black graduations, and the spindle is equipped with a lock for taking repetitive measurements.

GT102\$23.95



COMBINATION SQUARES

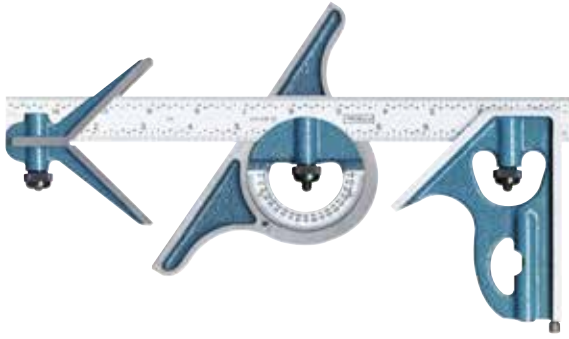

- Protractor has level
- Square head has level and scribe point
- Includes square head, center head and protractor
- Double-indexed protractor is graduated 180 degrees in both directions

PART	SIZE	GRADS	PRICE
52-375-012	12"	32nd, 64th, 50th, 100th	\$248.95
52-375-018	18"	32nd, 64th, 50th, 100th	\$239.95

CALIPERS AND DIVIDERS

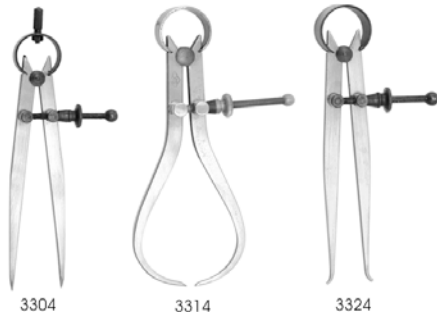

These spring-joint calipers and dividers are fully hardened and heat treated. Brushed finish.

PART	SIZE	PRICE
3304	4"	\$11.95
3314	4"	\$10.95
3324	4"	\$10.95

MICROMETER STAND



52-247-005

52-247-000

Fowler micrometer stand adjusts to any position. Provides a measuring position and angle for outside micrometers and other instruments.

52-247-005	(Folding)	\$55.95
52-247-000	(Adjustable)	\$82.95

DIAL BORE GAUGE SETS



- Carbide anvils
- Easy-to-read
- Includes extension holder & case
- Chrome plated handle
- Insulated grip
- Economical

PART	RANGE	GRAD	PRICE
52-646-300	2-6"	.0005"	\$145.95
52-646-400	1.4"-6"	.0005"	\$189.95

PLUNGER DIAL INDICATOR

The highly sensitive plunger detects small imperfections in your stock or machine with accuracy to .001. The 2-1/2 diameter face can be rotated for setting at any point, and includes adjustable limit indicators for marking important readings. There is also a lug mount on the back of the Dial for mounting to a magnetic base.



GT109 \$25.95

AGD INDICATOR AND FINE ADJUST MAGNETIC BASE



DIAL AND MAGNETIC BASE



- **Indicator Features:**
 - 1" travel
 - AGD group 2
 - 2-1/4" dial diameter
 - Reading: .001"
 - Continuous reading 0-100
- **Magnetic Base Features:**
 - 85 lb. pull
 - Fine adjustment
 - V-bottom base

52-585-110	(Dial and Magnetic Base Set)	\$155.95
P52-520-109	(Black Face Dial Only)	\$73.95
P52-520-110	(White Face Dial Only)	\$91.95
P52-520-129	(High Precision Dial Only)	\$117.95
52-585-005	(Magnetic Base Only)	\$49.95

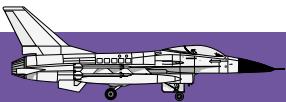

PRECISION MEASURING

10' DECIMAL AND METRIC TAPE MEASURE



For ultra precise measurements in both decimal reading and metric. The decimal scale is graduated in 50th (.02) of a foot for the first foot and 10th of an inch for rest of the tape. Metric graduated in millimeters throughout the blade.

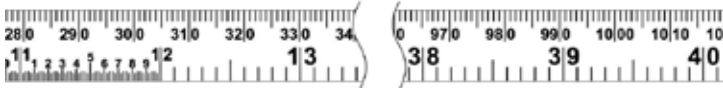

7210.....\$14.95

EZ READ RULES



The combination of a black chrome finish and precisely etched white graduations make these rules very easy on the eyes. Manufactured from a hardened steel for flexibility and durability.

PART	LEN	WID	GRAD	PRICE
EZ6	6"	1/2"	10th, 100th, 32nd, 64th	\$10.95
EZ12	12"	1/2"	10th, 100th, 32nd, 64th	\$20.95
EZ18	18"	3/4"	10th, 100th, 32nd, 64th	\$39.95
EZ24	24"	3/4"	10th, 100th, 32nd, 64th	\$59.95

SATIN CHROME STEEL RULES



PART	LEN	WID	GRAD	PRICE
52-340-006	6"	3/4"	32nd, 64th, 10th, 100th	\$10.95
52-340-012	12"	1-1/8"	32nd, 64th, 10th, 100th	\$25.95
52-340-018	18"	1-1/8"	32nd, 64th, 10th, 100th	\$39.95
52-340-024	24"	1-1/8"	32nd, 64th, 10th, 100th	\$56.95

ANGLE PROTRACTOR



A practical tool for measuring and duplicating difficult angles where a standard protractor cannot fit. Measure and mark the degrees of an angle on outside, inside and sloped angles. Fine black graduations from 0° to 165° in opposite directions.

GT29.....\$5.95

FRACTION+ DIGITAL CALIPER



This 6" stainless steel digital caliper measures in decimal, millimeters, and *fractions* with guaranteed accuracy to 0.001". Rugged metallic display housing superior to plastic digital display cases. Resolution 0.0005" (0.01mm). Accuracy 0.001" (0.02mm). Auto on/off feature.



- GT1433 (3")\$19.95
- GT146 (6")\$29.95
- GT1478 (8")\$59.95

ROUND HEAD PROTRACTOR



Steel protractors are for setting bevels and measuring and marking angles. It has permanently etched graduations for 0 to 180 degrees in opposite directions. It has a 3-3/8-Inch by 2-Inch head. The 6-Inch adjustable protractor arm locks into desired position with knurled thumb nut.

GT18\$14.95

STEEL PROTRACTOR

The 6" adjustable arm is ideal for setting bevels, taking measurements and transferring angles. Ultra-fine etched graduations read from 0 to 180 degrees in forward and reverse directions, and will not wear or rub off. Made of ground stainless steel for precision and durability.



GT17 (Mechanical)\$16.95





SCREW PITCH GAUGES

Set of 51 screw pitches combines all sizes from 4 to 84, including 11-1/2 and 27 pipe thread sizes. Knurled thumb nuts lock the case in an open or closed position.



GT251 \$54.95

RADIUS GAUGES

Precision ground gauges are used to check layouts and radii. Each has a concave and a convex radius. Stamped radius size on each lead. All gauges have a locking device.



PART	SIZE	GRAD	PRICE
52-470-100	1/32"-1/4"	64th	\$35.95
52-470-102	17/64"-1/2"	64th	\$39.95
52-470-120	1/32"-17/64"	64th	\$36.95
52-470-121	9/32"-33/64"	64th	\$43.95

FEELER GAUGE

Feeler gauges are used for adjusting and gauging spark plugs, distributor points and valve clearances, or any other instance of measuring the space between two parts. Precision Series Gauges are made of high-grade precision steel with etched numbering for easy identification.



GT226 (.0015 to .025 .) \$24.95
68050..... (11 Offset Blades, 1/2" x 4") \$6.95
68100..... (31 Blades .0015" to .035")..... \$8.95

SHEET METAL AND WIRE GAUGES

Gauge numbers are U.S. standard 0 to 36. Decimal equivalents are stamped on reverse side.



21..... (Sheet Metal Gauge) \$20.95
20..... (Wire Gauge) \$20.95

CONTOUR GAUGES



Contour gauges are designed for precise surface duplication in sheet metal work. The 35 ultra-thin pins per inch assure that you are getting an exact replication of your copied shape. Capable of duplicating surfaces up to 3-1/2" deep.



GT837 (6") \$10.95
GT833 (10") \$21.95

TELESCOPING GAUGES



Individual sizes available online at www.aircraft-tool.com.

Double action (self-centering) contact point ends are made of hardened tool steel and precision ground on a radius of the smallest hole the gauge will enter. This kit has size range 5/16" to 6".

903.....(Complete Kit)..... \$39.95

FULL BALL HOLE GAUGES



Individual sizes available online at www.aircraft-tool.com.



Ball hole gauges are used to determine the diameter of small holes. They will measure inside diameters of holes and grooves ranging from 1/8" to 1/2". Makes an ideal companion for our telescoping gauges. Complete set Range: .125-.500". set of 4 gauges includes part numbers: 97A, 97B, 97C, and 97D.

97S.....(Complete Kit)..... \$29.95

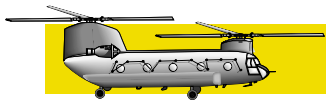

TEST & INSPECTION

ATS DIGITAL PROTRACTOR



- Large LCD display
- Self Calibrating
- Resettable zero point for relative readings
- Accurate to within +/- 0.1 degrees
- Reads all angles in a 360° range
- Batteries included

This ATS Digital Protractor provides absolute measurement and relative measurement to an accuracy of 0.1 degree. The 2.75" wide by 1.50" high LCD screen display automatically flips upright when turned upside down. It's self calibrating and delivers repeatable readings to within +/- 0.05 degrees (0.1 degree overall accuracy of level or plumb). The frame is extruded aircraft grade 6061 aluminum, with precisely flat measuring surfaces, and the upper surface has a V-groove to aid measurement on curved surfaces. Includes carrying case with belt clip.

ATS360..... \$149.95

360° DIGITAL PROTRACTOR (PRO360)



This precision instrument is engineered to be accurate to within 1 degree of level and plumb, it provides a full 360 degree reading so that the unit may be used accurately, even upside-down. Reading hold feature lets you take a reading in any situation. Machined aluminum frame will take just about any punishment. Batteries are included. 1-year warranty.

PRO360 \$249.95

TRUTACH II DIGITAL PROPELLER TACHOMETER



The all digital TruTach II measures propeller RPM to a remarkable accuracy of 1 RPM. It features a digital signal filter that eliminates noise and gives solid readings. TruTach II works on single or multi-engine propeller aircraft with 2, 3, 4, or 5 blades, and it never needs adjustment. Easily check calibration anytime with a standard light. RPM Range 240 - 7000 RPM. Uses a standard 9 Volt battery (included). Compact 3.8 x 2.4 x 1.5 inches and weighs just 4 Ounces. Includes impact resistant carrying case. 5 Year Warranty. Designed by Pilots for Pilots.

TRUTACH2 \$241.95

DIGITAL TORQUE ADAPTER/CALIBRATOR

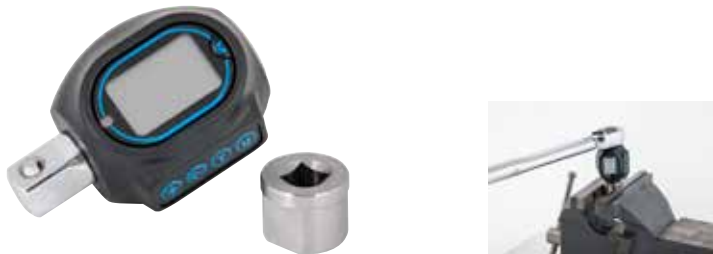

- 1/2" drive
- Measures in: Kg-CM, Kg-M, in-lb, ft-lb, and N-m
- Range: 50-600 ft-lbs
- LED backlight
- Swivels 240 degrees
- Screen flips 180 degrees
- 10 Memory settings

This digital torque adaptor also serves as a calibration device for torque wrenches. Use it to convert any ratchet wrench into a digital torque wrench. Can also be used to verify the calibration of any type of torque wrench. Includes a calibrating block.

23154..... (1/2" Drive) \$57.95

PRECISION PROPELLER PROTRACTOR



The 23-1990 Propeller Protractor is a 4-way precision instrument that measures angles directly between two surfaces, or any number of surfaces, such as setting a detachable blade type propeller on an airplane. Snug fitting circles are tooled to close tolerances that minimize the error and play found in other protractors. It has a matte finish to cut glare. This facilitates quicker and easier readings.

WD-PP1 \$45.95



ATS "VOYAGER" VIDEO BORESCOPE

Includes 3
Tip Mirrors

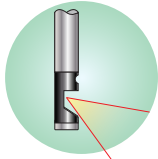

70° Forward Oblique

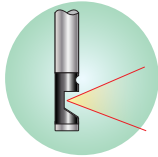

90° Right Angle

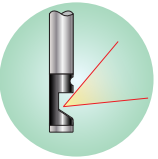

110° Rear Oblique



240° TWO-WAY
ARTICULATION

- 2-Way Articulation 120° side to side (240° total)
- 6mm (0.24") diameter probe fits spark plug holes
- 1 meter (39.4") flexible shaft
- Side lighting virtually eliminates tip mirror glares and streaks
- Includes 3 tip mirrors: 70° forward, 90° right, 110° rear
- 70° Field of View (FOV), Focal Range: 15mm to infinity
- Illumination from 4 forward LEDs (and 2 glare-free LEDs)
- 3.5" high resolution full color LCD display
- Records video and images at full 640x480 VGA onto SD card
- Built-in rechargeable battery lasts up to 6 hours



Scan to view
video



The state-of-the-art ATS Voyager videoscope features an articulating tip that swings 240 degrees to reach every inspection point of an airplane. With a simple turn of the control knob, you can move its Stainless Steel-sheathed tip from side to side to look left, right, and even backwards, giving you unprecedented access to areas that simply cannot be reached with a straight probe. Included with the ATS Voyager are three (3) tip mirrors to look 70°, 90°, and 110° to the normal line of sight. And on that score, the ATS Voyager features a remarkable innovation that places an extra set of LED lights to the side of the probe, which when activated, successfully eliminates the glare and spots that are sometimes present when looking through a mirror. The result is an absolutely crystal clear, well lit, image through the tip mirror. The camera captures video and stores them onto an SD card. The 3.5" display shows images with excellent clarity. The flexible 1 meter probe bends to any shape, while the sealed 6mm tip will resist dirt, scratches, and abrasions associated with normal use.

ATS-VS22(Complete Kit) **\$1,399.95**

ATS BORESCOPE FIELD KIT

This complete accessory field kit will make for a well-practiced inspection. The ATS BoreScope Field Kit includes the ATS-VS22H Holding Tube and the ATS-VS22B Field Bag.

The ATS-VS22H Holding Tube lends support to the flexible probe and gives it the rigidity that is necessary to reach into deep recesses while maintaining the precise control and freedom the new videoscopes offer.

The ATS-VS22B Field Bag will give you the extra hand needed to perform a full inspection. This heavy duty protective bag will keep your valuable videoscope safe from harm in the field. It includes a set of harnesses that wrap around your neck and waist and suspends your unit.



ATS-VS22H(Holding Tube) **\$59.95**
ATS-VS22B(Field Bag)..... **\$69.95**
ATS-VS22K(Field Kit with bag and tube) **\$125.95**

TEST & INSPECTION

USB ARTICULATING BORESCOPE



The new Vividia VA-400 is a USB controlled video borescope with a variable 1-way articulating tip that connects to any Android™ or Windows™ device. The probe, at only .33" (8.5mm) diameter, will fit into a spark plug port for cylinder inspections. The articulating tip swings through a full 180° to see the valves, wall, piston, and rings. The VGA resolution (640x480) camera auto-focuses from 1.57" (40mm) to 16" (400mm). And it's 6 LED tip lights serves to clearly illuminate the inspection area.

Best of all, the VA-400 is USB controlled, which means that you can view and record your inspections using a compatible phone, tablet, or laptop. It's an excellent and affordable addition to every mechanic's and IA's tool kit.

- VA-400 (Unit Only) **\$199.95**
- VA-400-A (Unit With WiFi Adapter for Apple Devices) **\$295.95**
- VA-B2.....(WiFi Adapter for Apple Devices) **\$109.95**

INSPECTION MIRRORS



All angle ball joint. Insulated vinyl grip.

PART	FACE	DESCRIPTION	PRICE
S22	3-1/2"x2"	16" Telescoping	\$10.95
E22	2-1/4" dia.	14" Telescoping	\$10.95
C22	1-1/4" dia.	8-1/2" long with clip	\$8.95
B22	1"x2"	8-1/2" long with clip	\$7.95

3X POWER MAGNIFYING TELESCOPING MIRROR



Use the Telescoping Magnifying Mirror to inspect small objects in areas that are out of reach or obstructed. The 3x glass magnifying mirror can be helpful when checking the bottom end of a motor for leaks, etc. The stainless steel telescoping wand extends from 8-1/2" to 29" in length.

- 316M..... (2-1/2" x 3" Rectangle) **\$14.95**
- GT759563(2-1/2" Diameter Round)..... **\$14.95**

TELESCOPING LIGHTED INSPECTION MIRROR



Our Lighted Telescoping Inspection Mirror allows you to peer into the dark crevices of your work space in search of leaks, breaks or lost tools. The telescoping shaft extends and the shatter-resistant mirror sits on a 360 degree swivel head for accurate positioning.

- GT80560(Rectangle)..... **\$16.95**
- GT80557 (Circle) **\$16.95**

TELESCOPING MAGNETS



Use to pick up ferrous metal parts and tools. Lifts up to 1 lb.

- 02..... (18") **\$6.95**
- 03..... (8" with pocket clip) **\$6.95**



TELESCOPING LIGHTED MAGNET & MIRROR SET



The pickup wand features a bright white LED light at the end of the chrome plated shaft that telescopes to 26". The magnet lifts up to 5lbs, and shielded so it won't attract peripheral objects. The 2-1/4" diameter oversized mirror is mounted on a universal joint that adjusts to any angle, and the chrome plated shaft telescopes to 36". Both the pickup and mirror feature foam covered handles for comfort. Complete set includes a carrying case.

ELB910..... \$19.95

PICKUP TOOLS

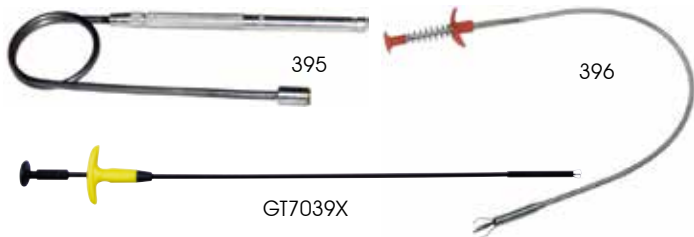

Excellent tool for picking up parts in hard-to-reach areas.

395..... (20" Magnetic Pickup) \$7.95

396..... (18" Claw Pickup) \$7.95

GT70396 (Lighted 24") \$12.95

GT70399 (Lighted 36") \$13.95

STEELMAN BEND-A-LIGHT



Bend-A-Light is a flexible high intensity light that bends to any configuration and illuminates hard-to-reach areas where conventional lighting cannot go. High intensity halogen bulb provides ample illumination for any type of inspection task.

10150A (16" Bend-A-Light) \$27.95

BRIGHTYES PRO

The perfect solution when you need a flashlight, but you need both hands free. It places two high-intensity beams wherever you look and allows both hands free to work. Batteries included.



80205..... \$14.95

INFRARED THERMOMETERS



The Heat Seeker Infrared Thermometers are precision measuring devices used to obtain accurate temperatures without having to contact the object being measured. It works by capturing and measuring the invisible infrared energy naturally emitted by all objects. It offers an easy and safe way to measure surface temperatures of objects which are difficult or unsafe to contact. They have a rugged, ergonomic design and feature a backlit LCD display with built-in laser sighting. The practical distance-to-spot ratio of 8:1 is suitable to accurately measure cylinder head, exhaust, manifold, and brake temperatures.

IRT670 (1400°F) \$220.95

IRT657 (1076°F) \$52.95

55010..... (-26°F - 842°F) \$29.95

TELESCOPING FLASHLIGHT WITH MAGNET



Here's an LED flashlight with a twist -- it telescopes to 20" and has a powerful magnet at the end to make it the ultimate magnetic pickup tool. Simply extend the shaft, light up, and go!

DA75570 \$15.95

BINOCULAR MAGNIFIER



The Binocular Magnifiers offer powerful, crisp magnification of your detailed projects while simultaneously leaving both of your hands free to work. The ground and polished optical lens is mounted to a tilt-up frame, allowing you to disengage the magnifier without removing the entire assembly from your head.

GT950-5 \$34.95



TEST & INSPECTION



MAGNAFLUX® ZYGLO™ PENETRANT TEST KIT



Under the high-intensity Zyglo Black Light you see cracks and defects as glowing signals - even ones you'd miss entirely by any other penetrant test method. The Portable 100-watt Black Light, supplied with the kit, is unique in its high-intensity black light output -- much higher than standard lights. With this intense black light and the strongly fluorescent Zyglo penetrants, defects glow brilliantly in normally lighted areas. With Zyglo you get increased inspection efficiency and accuracy at a remarkably low cost. Kit consists of 1 can ZL-27A Penetrant, 1 can ZP-9F Developer, 2 cans SKC-S Cleaner/Remover, and the portable 100-watt Black Light (115 AC., 60Hz). Comes complete with instructions, cleanup scrubs, and cloth.

- ZA70**.....(Complete Kit)..... \$2,184.95
- ZP-9F**(Developer, 12 oz. Aerosol Can) \$22.95
- ZL-27A**(Penetrant, 12 oz. Aerosol Can) \$38.95
- SKC-S**.....(Cleaner/Remover, 12 oz. Aerosol Can) \$17.95

MAGNETIC FIELD INDICATOR



An extremely sensitive magnetic field detector used Magnaflux products to identify defects in metals. Measures in the range of -10 to 0 to +10 gauss.

- 7308**.....\$66.95

MAGNAFLUX® SPOTCHECK DYE PENETRANT TEST KIT



The General Purpose Dye Penetrant inspection kit is used throughout the industry for the detection of surface defects. Suitable for the inspection of most solids, Spotcheck Dye Penetrants give clear, vivid indications of surface flaws, for just pennies a check. The compact carrying case permits this complete, lightweight kit to be taken anywhere. Kit consists of 2 cans Spotcheck SP1 Penetrant, 4 cans SKC-S Cleaner/Remover, and 2 cans SKD-S2 Developer. Includes brush, cloth and instructions. 12 oz. aerosol cans.

- SK816**(Complete Kit)..... \$198.95
- SKL-SP2**(Penetrant, 12 oz. Aerosol Can) \$22.95
- SKD-S2**.....(Developer, 12 oz. Aerosol Can) \$20.95
- SKC-S**.....(Cleaner/Remover, 12 oz. Aerosol Can) \$17.95

MAGNAFLUX® PORTABLE SPOTCHECK KIT



An undetected crack can be deadly! Critical aircraft areas, especially around stud mounts, can and do crack. And sometimes the flaw is too small to be noticed with the naked eye. That's why you need the Magnaflux Spotcheck Portable Kit. It's a complete dye penetrant test kit containing everything you'll need to find surface defects in welds, castings, and forgings. The Spotcheck Portable Kit comes in a rugged plastic case and includes complete instructions.

- 2 cans of SKC-S Cleaner/Remover
 - 1 can of SKD-S2 Developer
 - 1 can of SKL-SP1 Penetrant
 - Carrier/Dispenser Pack
 - Marking Pen
 - Packet of SCRUBS™ Hand Cleaner
 - Wiping Cloth
 - Complete Instructions
- SK416** \$115.95



AVIATION SPARK PLUG THREAD REPAIR KITS



Using Heli-Coil® serrated aviation inserts is the only FAA approved method of repairing damaged spark plug threads. It is also the only method certified by engine manufacturers such as Teledyne-Continental and Textron-Lycoming. Serrated inserts, unlike regular inserts, must be expanded and staked in place. These kits contain all the Heli-Coil tools you'll need to do the job. They have a pilot tap, insertion tool, offset and staking tool, expanding tool, 20 serrated inserts (10 each 1/2" and 13/16" long inserts for the 18mm kit and 10 each 3/8" and 1/2" long inserts for the 14mm kit), and instructions.

PART	DESCRIPTION	PRICE
4260-18	18mm Aviation Spark Plug Repair Kit	\$1,599.95
2-50	Individual insert 18mm x 13/16", each	\$9.95
2-52	Individual insert 18mm x 1/2", each	\$8.95
4260-14	14mm Aviation Spark Plug Repair Kit	\$1,329.95
137-43	Individual insert 14mm x 3/8", each	\$8.95
137-22	Individual insert 14mm x 1/2", each	\$8.95

HELI-COIL® MASTER REPAIR KIT



Kit includes taps, inserts, drill specifications and instructions for repairing a wide range of the most commonly experienced coarse thread repair problems. Includes inserts in the following sizes (and quantity): 1/4x20 (12), 5/16x18 (12), 3/8x16 (12), 7/16x14 (6), 1/2x13 (6), 5/8x11 (6). Custom molded case also included.

4934.....\$412.95



HELI-COIL® SPARK PLUG REPAIR KIT (NON-SERRATED)



These repair kits contains everything you'll need to make on-the-spot engine repairs. Includes pilot tap, and installation tool, and 24 inserts.

Note: Use of non-aviation Heli-coil inserts may not be approved for your engine. Check with the manufacturer before using.

PART	DESCRIPTION	PRICE
5523-18	18mm Spark Plug Repair Kit	\$262.95
5523-14	14mm Spark Plug Repair Kit	\$237.95

HELI-COIL® INDIVIDUAL REPAIR PACKS



Heli-Coil has the most effective and universally accepted method of thread repair. Damaged threads can be restored to better-than-new condition. Each pack includes inserts, insertion tool, and tap.

PART	SIZE	PRICE	PART	SIZE	PRICE
5401-04	4-40	\$73.95	5402-06	6-40	\$102.95
5401-05	5-40	\$99.95	5402-2	8-36	\$115.95
5401-06	6-32	\$79.95	5402-3	10-32	\$79.95
5401-1	12-24	\$69.95	5402-4	1/4-28	\$79.95
5401-2	8-32	\$87.95	5402-5	5/16-24	\$83.95
5401-3	10-24	\$69.95	5402-6	3/8-24	\$90.95
5401-4	1/4-20	\$69.95	5402-7	7/16-20	\$90.95
5401-5	5/16-18	\$76.95	5402-8	1/2-20	\$125.95
5401-6	3/8-16	\$73.95	5402-9	9/16-18	\$167.95
5401-7	7/16-14	\$79.95	5402-10	5/8-18	\$178.95
5401-8	1/2-13	\$111.95	5402-12	3/4-16	\$205.95

For complete engine tools visit our website
www.aircraft-tool.com



ENGINE EQUIPMENT

ATS PRO DIFFERENTIAL PRESSURE TESTER KIT



I don't have to tell you how aggravating it can be to reach down into the cowling to get to those spark plug holes for a quick leakdown check. It's a real pain to get the hose to reach the spark plug hole without contorting your arm into pretzels. Well, agonize no more, because we've paired our top of the line ATS 2EM Differential Pressure Tester (with Master Orifice) with our Spark Plug Port Extension Tool to make your life a whole lot easier. Order this kit now and you'll never dread doing a leakdown test again.

2EM-KIT.....	(With 2EM).....	\$129.95
2E-KIT	(With 2E)	\$110.95
18MM-XT	(18MM Extension For ATS Compression Testers).....	\$29.95
14MM-XT	(14MM Extension For ATS Compression Testers).....	\$29.95
12MM-XT	(12MM Extension For ATS Compression Testers).....	\$29.95
E18MM-XT.....	(18MM Extension For EASTERN Compression Testers).....	\$39.95
E14MM-XT.....	(14MM Extension For EASTERN Compression Testers).....	\$39.95

DIFFERENTIAL PRESSURE TESTER W/ MASTER ORIFICE



The Model 2EM Differential Cylinder Pressure Tester combines the features of our popular 2E tester, and a Master Orifice into one tool. Check your engine's leakdown rate against a calibrated standard in accordance with Continental's Service Bulletin SB03-3.

2EM.....	(For Up to 5" Bores).....	\$109.95
2EM-14.....	(W/14mm Adpt).....	\$109.95
2EM-60.....	(For Over 5" Bores)	\$109.95

DIFFERENTIAL PRESSURE TESTER



Our own make comes with on-off safety valve to eliminate hose pressure when disconnecting from the cylinder. Use it to check valves, cracked or worn rings, defective cylinders, worn bushings, etc. Includes hose, plug adapter, and complete instructions.

2E.....	(For Up to 5" Bores).....	\$89.95
2E-14.....	(W/14mm Adpt).....	\$89.95
2E-60.....	(For Over 5" Bores)	\$89.95



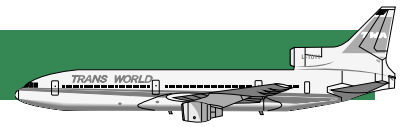

ENGINE TEST KIT



The ATS engine test kit has all the test equipment needed to check engine compression, synchronize magnetos, time aircraft engines, and test the aircraft ignition leads in one tool box. The kit contains: 2E (or 2EM) pressure tester; 8" extension tube; LED52 magneto synchronizer; Eastern E25 timing indicator; Eastern E5 cable tester; and a tool box.

EK5	(With 2E)	\$399.95
EK5EM	(With 2EM and Master Orifice)	\$385.95
EK5T	(2E W/ US Industrial Cable Tester)	\$335.95
EK5EMT	(2EM W/ US Industrial Cable Tester)	\$349.95

ENGINE CALIBRATION & SET UP KIT



This kit gives you the innovative tools to help eliminate mistakes when getting your engine timing done. Kit includes a compression whistle, a Top Dead Center Indicator, a Crank Stopper, and a complete set of adapters for 18mm, 14mm, and 12mm spark plugs.

7891 \$132.95

AVIATION LABORATORIES ENGINE OIL ANALYSIS KIT



Aviation Laboratories' test kit determines the condition of oil wetted engine parts even on the first sample. The kit includes 1 test kit, and all lab work for each kit. This oil analysis kit is used for determination of the condition of oil wetted engine parts, even on the first sample. Aviation Laboratories will analyze 12 wear metal elements for piston and turbine engines, and post the results online for your private review. The analysis is usually completed within 24 hours, and if they detect an abnormal condition, they will contact you immediately to alert you to potential engine problems. Complete kit includes sample bottle, siphon hose, and full instructions.

AVL-GA001 \$21.95

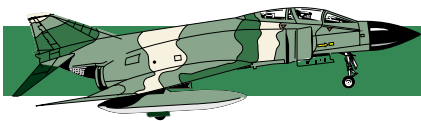

ENGINE EQUIPMENT

MASTER ORIFICE TOOL



The Master Orifice Tool is required by Continental's SB03-3 Service Bulletin. Use it with Eastern's E2, or our own 2E Differential Pressure tester to determine your calibrated leakage reading prior to engine testing. It is available in either plated steel (SPX), or non-sparking brass (ATS). **Note: This tool is not needed by our (ATS) 2EM or Eastern's E2M, as they already have a built-in master orifice.**

- 6469.....(ATS Model).....\$75.95
- 646953A(SPX Model).....\$99.95

BENDIX MAGNETO P-LEAD ADAPTER



This unique design of the P-lead Adapter allows you to connect to the timer leads of Bendix magnetos with an immediate and positive connection. It provides secure and stable alignment, and includes a post that prevents the timer leads from falling off.

PART	WORKS WITH BENDIX	PRICE
8765	Early S4, S6 & S20 mags (3/8" p-lead)	\$35.95
8766	All other S series mags (1/4" p-lead)	\$35.95
8767	D2000 & D3000 series mags	\$35.95
8768	Set of all 3 adapters	\$95.95

MAGNETO LOCKING TOOLS



Use this to lock magnetos and maintain the correct timing position prior to removal or installation of the magneto.

- ML20(for Bendix magnetos).....\$6.95
- T118(for Slick magnetos)\$6.95

ELECTRONIC MAGNETO SYNCHRONIZER



"Small and reliable. It's exactly what I needed to time the mags on my airplane. I keep it in the toolbox on-board just in case." -S. Grant

Revolutionary design uses a high frequency electronic signal instead of high voltages to determine when the points of the magneto break. It will reliably indicate breaks so that you can accurately adjust the magneto's internal timing, or synchronize it to the aircraft's engine. Completely safe and foolproof. Dimensions are 3"x5"x2-5/8".

- LED52(Dual Mag, w/ Tone)\$62.95
- LED51(Single Mag, w/ Tone)\$56.95

MAGNETO TIMER



This tool simplifies magneto timing on TCM (Continental) series 470, 520, and 550 engines. No protractor on the spinner required, or other complicated tooling. Simply place it over the prop nuts and sight down the casing split to set the timing. That's all there is to it. It's foolproof. Comes with instructions right on the tool for easy reference.

- CCMT-01\$41.95

MAGNETO E-GAP TIMING KIT



The Magneto Internal Timing Kit is used to set the "E" Gap on Bendix S-20, S-200, S-400, S-500, and S-1200 series aircraft and industrial magnetos. Complete kit with instructions included.

- 11-8150\$115.95

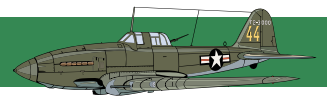

EASTERN MAGNETO SYNCHRONIZER



The Eastern "buzz-box" magneto synchronizer is perhaps the most well known of its type. Its simple design makes it absolutely fool-proof. Just attach the leads to the magneto, and adjust until you see the lights and hear the buzz!

E50.....\$121.95

HIGH VOLTAGE CABLE TESTER



- Fail-safe circuitry
- Unbreakable case
- Compact 3" x 5" x 2-5/8"
- Heavy-duty lead wires

Designed to give you a fast accurate test of Hi-Voltage aircraft ignition cables. Simply connect three wires, push the test button and the test is completed. The E5 will instantly indicate in its test window both good and defective cables. There is no waiting for any indication to appear.

E5.....\$121.95

TIMING INDICATOR



This all aluminum unit is designed to improve and speed up the process of timing magnetos to the engine. It easily attaches to the propeller spinner, and has an accuracy of 1/2 degree. The easy to read dial can be viewed from any angle. Comes with top dead center locator and mounting bands.

E25.....\$76.95

SLICK® MAGNETO OVERHAUL TOOL KIT



Slick magnetos must be overhauled every time you perform an engine overhaul. Additionally, they must be overhauled whenever there is a lightning strike, or sudden engine stoppage. This kit contains all of the tools you will need to perform a complete magneto overhaul in accordance with Unison Industries L-1037 and L-1363B Service manuals. The complete kit contains: Bearing Assembling Plug, Rotor and Frame Assembling Plug, Puller, Base Adapter Plate, Timing Pin, Adapter Plate Bushing, Bearing Puller, Wedge Extractor, Timing Plug, Assembly Fixture, "E" Gap Gauge, Cam and Rotor Set, Spacer, Alternate Cam and Rotor Set, Spacer. **Note: This kit does not include magneto replacement parts.**

T100.....\$885.95

SLICK® IGNITION HARNESS ASSEMBLY KIT



The Slick® Assembly Tool Kit is required to install all Slick Ignition Harness Leads on all magneto harness caps and spark plug termination ends. The complete kit includes: Pressing Tool, 72 Drill Bit, Pin Vise, Stripping Tool, Spring Assembly Tool, and Shield Stripper. Complete instructions for the use of this kit can be found in the Unison Industries L-1178 Service Manual.

T200.....\$299.95



ENGINE EQUIPMENT

When its just got to be right
use a **TIMERITE®**



The TimeRite® has been in service since WWII, and for over 25 years ATS has been the exclusive manufacturer of this extraordinary tool.

This classic was originally designed for the military to quickly and efficiently time engines in the field. The TimeRite® uses specialized arms and calibrated scales to accurately locate Top Dead Center, and allows you to set the timing angle with dead-on accuracy.



ENGINE EQUIPMENT

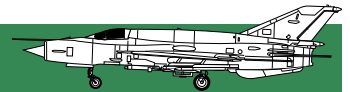

TIME-RITE®



The Time-Rite uses specialized arms and calibrated scales to accurately display piston and angular displacement to 1°.

The basic Time-Rite unit (I200B18 and I200B14) does not include any arms or scales. You must purchase these separately for the specific type of engine you intend to service. The complete Time-Rite kits (I200B18K and I200B14K) include the basic unit plus the complete set of Arms and Scales.

PART	DESCRIPTION	PRICE
I200B18	Basic 18mm Time-Rite Unit	\$345.95
I200B14	Basic 14mm Time-Rite Unit	\$329.95
I209-12	Engine Scale: specify the desired scale when ordering e.g. I209-5A	\$16.95
I205-X	Engine Arm: specify the desired arm when ordering e.g. I205-D	\$20.95
I200B18K	Complete 18mm Time-Rite Kit	\$599.95
I200B14K	Complete 14mm Time-Rite Kit	\$489.95
I200BCK	Combo 14 & 18mm Time-Rite Kit	\$679.95

ENGINE MAKE	ENGINE MODEL	TIME RITE	SCALE	ARM	U/D
ALLISON	V-1710-143, -145	B18	12	H	Dn.
CONTINENTAL	A-SERIES	B18	5B	D	Up
	C-75; C-85; C-115; C-125	B18	5A	C	Up
	C-90; C-145; O-300-A thru D; O-200 A thru F	B18	10B	C	Up
	E-165; E-185, 1, 3, 8, 9, 11; E-225-4, 8 (with 532452 Cylinders); IO-470-J; O470-A, E, J, 11, 15 (with 532452 Cylinders)	B18	10A	D	Up
	E-165; E-185, 1, 3, 8, 9, 11; E-225-4, 8; O-470-A, E, J, 11, 15 (with 536727, 538348, 528610 Cylinders)	B18	13A	E	Dn.
	F50-526-A (ATC); G50-526-A (ATC)	B18	20A	X	
	GIO-300; GO-300-A, B, C, E	B18	21A	U	Up
	G50-526-A (BTC)	B18	20B	A	Dn.
	IO-470-C, G; O-470-B, G, H, M, N, P, 2, 13, 4	B18	13B	E	Dn.
	IO-470-D, E, F, H, K, L, M, N, R; IO520	B18	17	S	Up
	O-470-G, H	B18	21B	T	Up
	O-470-K, L, R, S	B18	17A	S	Up
	R-9A; R-760; R-975-C1, C2, C3	B18	4A	C	Dn.
	W670	B18	4B	C	Dn.

ENGINE MAKE	ENGINE MODEL	TIME RITE	SCALE	ARM	U/D
LYCOMING	D2; O-145-B, C	B18	9A	C	Up
	O-235; O-290-11; O320, A, C, E; O435-17, 23; O-480-1, A1, A6; IO-320-A	B18	9B	E	Dn.
	VO-435; GO-435; GO-480-A1, A6, B, B6, D, F, F6; GO-580; GSO-480-A1A6, B1A6, B1B6; GSO-580; IGSO-480-A, A1, A6, B6; TVO-435; TVO-435-B1A	B18	9B	E	Dn.
	O-340-A; O-290-D2B; O-290-D2C	B18	18B	V	Dn.
	GO-480-C, C1B6, C2D, G2D6; GO-480-C1D6; GO-480-C2C6	B18	19	E	Dn.
	O-290-D; O-435-A	B18	13A	V	Dn.
	R-680 (5:5:1)	B18	3A	C	Dn.
	IO-540	B18	9A	T	Up
	IMO-360-B	B18	19	E	Up
	IO-320-B1A, B, C; O-320-B, D; O-235-C1; O-290-D, O2B; O-435-A; O-540-B2B5	B18	9A	E	Dn.
	GO-480-B1B, B1DB, D1A; GO-435-C2, C2A, C2B, D1; GSO-590-C; GSO-580-D	B18	9A	E	Dn.
	O-360-A1D; O-360-C; O-540-D, E, F; IO-540-D4A5; IO-360-A, B	B18	29A	U	Up
	IMO-360-A; O-360-A, A1A, A, B; MO-360; IGO-540; O-540-A, A1A; IGSO-540, A1A; O-340-A1A	B18	18A	D	Up
	IVO-360-A; HO-360-A; HO-360-B; HIO-360-B; IO-540-C, D, J; HO-360; VO-360; VO-540	B18	18A	D	Up
	IO-720; IO-360-A1A	B18	18A	V	Up
	O-360-B; O-540-B	B18	19	R	Up
O-290-D-2	B18	18A	E	Dn.	
FRANKLIN	4A4; 6A4-150, 165; 6V4-178; O-335-3, 4	B14	7B	A	Dn.
	6A8-125	B14	7A	E	Dn.
	6A4-200; 6V4-200; O-335-2, 5, 5A, 5B, 6, 6B; YO-335-5	B14	8B	G	Dn.
	6A6-245; 6A8; 6V6-245; O-425-1, 5, 9	B14	8A	R	Dn.
JACOBS	L4; R755A; R755B2	B18	6B	C	Dn.
PRATT & WHITNEY	R-985; R-1830; R-1535	B18	24A	A	Up
	R-2000; R-2800	B18	24B	A	Up
	R-1340-H1; R-2180; R-1690-E	B18	23A	A	Dn.
	R-4360	B18	23B	A	Up
R-1340C, D	B18	23A	C	Dn.	
RANGER	6-440-C	B18	3B	A	Dn.
ROLLS-ROYCE	V-1650, 23, 25	B14	15	J	Dn.
	GIPSY QUEEN 30 MK.2 & 70 MK.2	B14	25A	C	Dn.
	GIPSY MAJOR 140	B14	28A	D	Up
GIPSY MAJOR 10 MK.2	B14	25B	R	Dn.	
WARNER	125, 145, 165, 185	B18	6A	C	Dn.
WRIGHT	R-1300-1A, 2A, 3, 4, C7BA (805941)	B18	11A	K	Up
	R-3350-75 (80594); 749C18BD1 (805941)	B18	11B	G	Up
	R-1820-54, 72 WA, 60, 62, 62A, 74W, 76, 76A, 76B, 76C, 76D, 80, 80A, 82, 82A, 84, 84A, C, D, 86, 86A, 97, 101, 103, 103A, C9GB, C9GC, C9HD, C9HE (805940)	B18	2B	B	Up
	R-2600-8, 13, 20, 29, C14BB; R-3350-8, 13, 23A, 24W, 24WA, 35, 35A, 57M, 57AM, 83; 745C18BA-3 (805940)	B18	2A	B	Up
	R-3350-26W, 26WA, 26WB, 30W, 30WA, 30WB, 32W, 34, 77, 85, 89, 91 (805942); 861C18CA-2; 956C18CA; 927IC18DA-1, 2, 3, 4; 975C18CB-1, 986IC18EA-1, 2, 3	B18	14B	M	Up
	R-760; R-975	B18	4A	C	Dn.
	R-3350TC18	B18	14A	MA	Dn.
	R-3350-C18BD	B18	11A	G	Up

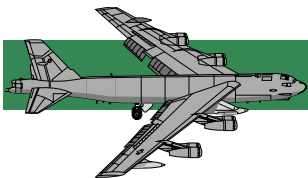

ENGINE EQUIPMENT

ATS SPARK PLUG CLEANER AND TESTER

THE #1 SELLING TESTER IN THE AVIATION INDUSTRY



"We have been using this spark plug cleaner machine for over two years and it has never let us down. Spark plugs come out looking brand new. The best part of the unit is that you can test spark plugs under the same conditions as they are in in a running engine."

BEFORE



AFTER



Specifications:

- Operating voltage: 115V or 220V AC Single-phase 50/60Hz
- Recommended air pressure: 100 to 140 psi (7 to 10kg/cm²)
- Cleaner section abrasive capacity: 1 lb. (900g)
- High-voltage output when spark testing : 24,000V
- Dimensions: 19.3" (49cm) x 11" (28cm) x 10.4" (26cm)
- Weight: 20.5 lbs (9.3kg)
- Accessories included: 12mm, 14mm and 18mm spark plug adapters (2pcs each); 12mm, 14mm and 18mm cleaner gaskets (1 each); Adapter case (1 pcs); Aviation Massive Electrode adapter plug (1pcs), Abrasive 1 lb. (900g)

The latest model of our popular Spark Plug Cleaner and Tester now operates on 120V as well as 220V without the need for converters. It also features advanced protection circuitry to prevent the unit from overheating during prolonged use. It has the same dependability and ease-of-use that's made our SPCT100 the 1 selling cleaner-tester in the industry, and carries a full 1-year warranty. It's still the best choice for anyone who needs to reliably and accurately check the quality of used spark plugs. The cleaner section uses a powerful blast of air and abrasive to thoroughly remove carbon deposits from plugs. The recessed observation mirror is perfectly angled to display the electrodes of the spark plug so that you can clearly judge the quality of the spark as the plug is being tested. It is manufactured to the rigorous ISO 9002 standard. Includes adapters for 12mm, 14mm, and 18mm spark plugs. Works with Aviation and Automotive plugs. Features a motorized turntable for automatic, "hands-off" cleaning of plugs. Test plugs at 24,000 volts and up to 150 psi to simulate engine conditions.

Note: The SPCT100A will not remove lead deposits from spark plugs. The proper way to remove lead deposits is by using the Aircraft Tool Supply Vibrator Cleaner (p/n PA01).

SPCT100A.....(120/220 Volts) \$599.95



ENGINE EQUIPMENT

HEAVY DUTY SPARK PLUG GAPPER KIT



"It's truly portable, solid and it gaps quickly. If you ever have to do work in the field this would work great, you can toss it in a tool bag and practically forget about it because it takes up so little space. If you want to be really precise, it works great too." ~ airplanepilotmech

A complete spark plug gapping solution for field or bench use. Includes our ATS420 Heavy Duty Spark Plug Gapping Tool to accurately set your spark plug gaps to within 0.001". You also get a set of wire feeler gauges (p/n ATS450) to verify gap size. If you should happen to accidentally over-gap the plug, then the included Gap Expansion Tool (p/n ATS483) will get you back on track. Lastly, we've included an Electrode Erosion Gauge (p/n ATS482) to make sure that your gapped plugs are still in serviceable condition.

ATS420DX	(Complete Kit).....	\$69.95
ATS420.....	(Gapper Only).....	\$39.95
ATS420K.....	(Gapper & Gauge)	\$45.95
ATS483.....	(Expansion Tool)	\$18.95
ATS482.....	(Erosion Gauge)	\$8.95

ATS SPARK PLUG GAPPER KIT



This economy gapping kit features the Sure-Gap gapping tool, which works with all 18mm massive electrode aircraft spark plugs and eliminates guessing of plug gap. The kit also includes our ATS450 retractable gap gauge. Wire gauges are made of stainless steel wire and are accurate to .0005". Gauge sizes are: .015", .018", .019", and .022". Wires can also be replaced when worn out.

116K.....	(Complete Kit).....	\$22.95
116.....	(Gapping Tool Only)	\$11.95
ATS450.....	(Wire Gauge Only)	\$21.95
ATS450-WG	(Replacement Wire)	\$8.95

ATS SPARK PLUG GAPPER



A low-cost efficient gap setting tool for closing gaps on massive electrode-type aviation spark plugs. Can be hand held, bench mounted, or held in a vise. Complete with one adapter for 18mm spark plugs, and one for REM37BY plugs. Also includes the ATS450 retractable gap gauge.

ATS415K.....	\$65.95
--------------	-------	---------

SPARK PLUG THREAD CHASER



Cleans threads in spark plug hole of dirt, carbon build-up, and metal particles. Double ended for both 14mm and 18mm threads. Neoprene band on hex drive holds tool securely in any 13/16" deep-well spark plug socket.

20200.....	\$8.95
------------	-------	--------

SPARK PLUG TERMINAL LEAD THREAD CHASER



Our new Spark Plug Thread chaser will remove galling and buildup from both the spark plugs and the lead coupler threads to ensure optimum electrical connectivity. Just run the thread chaser over the spark plug threads to clean it, then flip it over and run it into the lead connector to clean that as well. It's a simple and effective way to restore your threads to like new condition. Available in both 3/4" and 5/8" sizes.

ATS485.....	(3/4").....	\$29.95
ATS486.....	(5/8").....	\$29.95
ATS4856K.....	(Set of Both).....	\$55.95



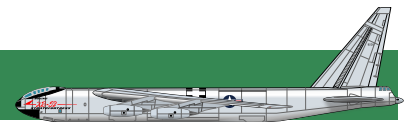

ATS MAGNETIC SPARK PLUG SOCKET

"I looked for a while for this perfect product. Get two, one for your tool box and one for your airplane tool kit." ~ D Meyer



Specially designed to accept longer aircraft massive electrode spark plugs. 3-1/2" overall length. 7/8" hex socket with 3/8" drive.

ATS950.....\$35.95

SPARK PLUG TRAY



Holds up to 12 spark plugs and is marked with the cylinder numbers (1-6).

FAP-12 (12 Hole).....\$35.95

FAP-18 (18 Hole).....\$52.95

SPARK PLUG VIBRATOR CLEANER



This tool will do the same job as the more expensive vibrator cleaners at a fraction of the cost. It removes heavy deposits in and around the electrodes with absolutely no risk of damage to the plug.

PA01\$39.95
 PA01-1 (Replacement Blade)\$3.05
 PA01-21T (Tip Assembly).....\$29.95

ATS SPARK PLUG THREAD LUBRICANT



A high-temperature, graphite lubricant that is applied to spark plug threads prior to installation to prevent galling and seizure. One 4oz. bottle provides enough lubricant for up to 200 applications. Non-hazardous compound.

ATS2612.....\$7.95

10X ILLUMINATED SPARK PLUG INSPECTOR



Use this 10X illuminated magnifier to check for cracked insulation, pitted electrodes, and deposits that can lead to engine failure.

DV980-10(Donagan)\$29.95
 52-660-050(Fowler Brand).....\$50.95

STAINLESS STEEL CLEANING PICKS



A set of four picks that are great for removing lead deposits from spark plugs. Contains 1 straight, 1 curved, and 2 hooked tips.

E900-205.....\$9.95

SPARK PLUG CLEANER



Cleans any size plug without changing grommet. Has 2-way valve (blast or air) and comes ready to use with abrasive powder.

12.....(Complete Unit).....\$29.95
 78B.....(Black Diamond Abrasive).....\$3.95
 78W.....(Crushed Walnut Abrasive).....\$2.05
 C12B.....(Replacement Canvas Bag).....\$3.95
 12GN.....(Replacement Grommet).....\$3.95



ENGINE EQUIPMENT

TEMPEST excellence

OIL FILTER MEDIA CUTTER



Every mechanic knows the importance of cutting the media open to spread the pleats for inspection of metal in the filter. In the past, this has been a difficult job to complete. Tempest's new AA471 provides a low cost, efficient and safe tool that every mechanic will want to put in their tool box.

AA471 \$40.95

OIL FILTER CAN CUTTER



The tempest universal oil filter can cutter features a compact design to easily fit in your toolbox while providing the same cutting power as the larger units. Comes with a set of adapters for both male and female oil filters. The hardened cutting wheel will cleanly cut through any type of filter including all Tempest and Champion Filters.

AA470 \$115.95

SPARK PLUG TRAY



The Tempest tray design is sturdy and balanced, reducing the likelihood of tipping. Rubber feet on the bottom of the tray help keep the tray in place on metal workbenches and tool boxes.

AA446 \$65.95

SPARK PLUG RESISTANCE TESTER



High internal resistance in spark plugs is rapidly becoming a concern that many IA/AP's are beginning to recognize as the source of rough running engines and chronic magneto related problems. The AT5K was created to address these concerns. It's a test

unit that will accurately measure the resistance of your spark plug and provide a quick go-no-go test to verify that the resistance is below the manufactures recommended level.

AT5K \$143.95

PISTON PIN REMOVAL TOOL

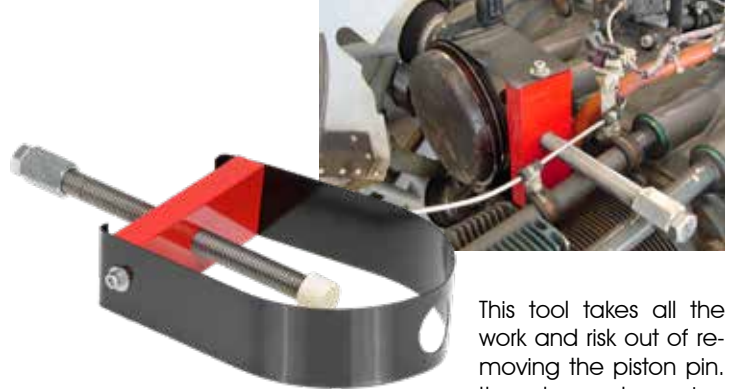

This tool takes all the work and risk out of removing the piston pin. It works on Lycoming and Continental engines. Just slip it over the piston, turn the shaft and it pushes the pin out smoothly and cleanly. Vinyl coated tip prevents scratching and marring the pin or piston during removal.

PT171 \$73.95

VALVE SPRING COMPRESSOR



Just attach in one of the valve cover screw holes and give it a couple quick turns to take the pressure off the rocker shaft. This allows you to work with two hands and slip out the rocker shaft. Combine this with our piston pin removal tool (PT171) and really save some time on your next cylinder swap.

RST172 \$45.95

PUSH ROD SPRING COMPRESSOR



You know how hard it is to get at the springs on the push rod tubes... Now, you can compress them and remove the tube in under a minute. Just slip this tool onto the spring and crank the shaft counter-clockwise (an air ratchet works great for this) to compress the spring, and then give everything a wiggle and out it comes. It's really that easy! This tool will pay for itself in one top end job. It's a must-have tool when working on big bore Continentals.

CST173 \$52.95



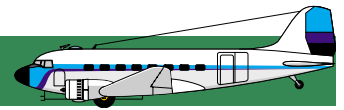

CHAMPION™ OIL FILTER CUTTER



Designed to cut open any spin-on type oil filter quickly and efficiently. It centers around the filter quickly, with no parts to change, and cuts in either direction. Cuts all Champion 3.7 Inch diameter filters. The CT923 also cuts the new Champion RBC308 filter used on the Rotax 912 and 914 engines.

- CT923..... \$304.95
- CT470-4 (Replacement Cutter Wheel) \$13.95

CHAMPION™ OIL NUT WRENCH



Designed for easy removal of Cessna oil filter adapters from 150 Series thru 300 Series aircraft. Manufactured from tool quality steel, features both 3/8" and 1/2" drives, as well as "flip over" reversability. This is the wrench to use when complying with Cessna AD 96-12-22.

- CT709..... \$132.95

CHAMPION™ LEAD-MASTER WRENCH

Lead-Master wrenches reduce time to remove and install spark plug ignition leads, also permits short arc turning due to 12-point grip head.



- CT913..... \$293.95

CHAMPION™ LEAD WRENCH

Special "T" handle designed open box wrench 7/8".



- CT912..... \$146.95

CHAMPION™ SPARK PLUG THREAD CLEANING TOOL



Designed to clean any 18mm aircraft engine spark plug port to ensure correct installation of new or overhauled spark plugs.

- CT449..... \$367.95

CHAMPION™ OIL FILTER TORQUE WRENCH



Makes it foolproof to attain the 17 ft/lbs of torque necessary when installing oil filters. Simply tighten the oil filter until the head "breaks" to ensure correct torque. Comes pre-calibrated from factory.

- CT921..... \$121.95

CHAMPION™ SPARK PLUG GASKETS

Use these copper gasket rings when replacing spark plugs to ensure a secure seal.



- M674K..... (Set of 8) \$5.95
- M674HD(Pack of 100)..... \$69.95

CHAMPION™ SPARK PLUG LUBRICANT

A high-temperature, graphite lubricant that is applied to spark plug threads prior to installation to prevent galling and seizure. The special compound will remain stable even at very high temperatures. 4 fl oz.



- 2612..... \$12.95



ENGINE EQUIPMENT

CHAMPION™ SPARK PLUG TRAY



A sturdy steel tray that holds up to 12 aviation spark plugs. Speeds handling of used or new plugs. Holes are numbered to correspond with engine cylinders. Protects against contamination.

- CT446..... (12 Plug Tray) \$59.95
- CT446-18 (18 Plug Tray) \$158.95

CHAMPION™ FINE WIRE GAPPING TOOL

Designed exclusively for adjusting fine wire electrode spark plug gaps. Two slot sizes fit all platinum or iridium ground electrodes for quick, safe adjustment.



- CT457..... \$69.95

CHAMPION™ RETRACTABLE GAP GAUGE

Gap gauge with 4 sets of accurate retractable go and no-go wire gauges for massive electrode aviation spark plugs. Wire sizes .015, .019, .018, and .022.



- CT450..... \$37.95
- CT450-WG (Replacement Wire Pack)..... \$21.95

CHAMPION™ GAP SETTING TOOL

An efficient gap setting tool for closing gaps on massive electrode-type aviation spark plugs. Can be hand held, bench mounted, or held in a vise. Complete with one adapter for 18mm spark plugs, and one adapter for REM-37BY plugs. Also includes a CT450 retractable gap gauge.



- CT415AV..... \$262.95

TACH DRIVE SEAL REMOVER



This straight forward tool will let you remove the tach seal in minutes time and time again. The seal removal tool is so easy to use, it's as easy as counting to five! One: remove the vacuum pump to give the tool plenty of room to work. Two: thread the alignment sleeve onto the housing as well as the puller. A 3/4" wrench is helpful here. Three: adjust the alignment sleeve so it can rotate freely. Four: install the slide hammer and bolt. Five: Firmly impact the bolt head with the slide to bring the seal out. That's it! Visit our website for complete instructional video.

- RPM-01..... \$314.95

OIL FILTER TOOL



The Oil Filter Tool was created to assist in removing a stuck filter, without resorting to the traditional hammer, punch, chisel, and or the huge pump plier's methods. Bogert Aviation wanted the tool to be safe in tight quarters and unable to slip, attempting to minimize damage to nearby components. This is still a messy process but this tool will always work to remove stuck filters without damaging anything else.

- BO-10M-TALON(Up to 1500 in lbs)..... \$51.95

SWIVEL-GRIPPER "NO-SLIP" OIL FILTER WRENCH



Tough, stainless steel band with permanently bonded textured coating for superior gripping power...won't slip. Handle swivels more than 180° with adjustable tension. Tension adjusting nut allows swivel pressure to be regulated... no more floppy filter wrenches. Specially designed tab keeps grip from sliding off the handle.

- 57010.....(2.375"-2.625" ROTAX) \$11.95
- 57030.....(3.5"-3.875")..... \$11.95



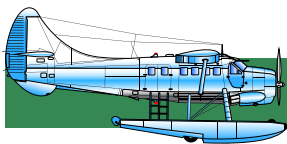

ENGINE EQUIPMENT

CHAMPION MASSIVE ELECTRODE SPARK PLUGS

Champion Spark Plugs are used in more airplanes than any other brand. Note: All spark plugs are shipped in a factory sealed case - opened cases are non-refundable.



REB37E	\$39.95
REM37BY	\$39.95
REM38E	\$38.95
REM40E	\$38.95
RHB32E	\$38.95
RHB37E	\$38.95
RHM38E	\$38.95
RHM40E	\$38.95

ENGINE MODEL	5/8"-24 SHIELD	3/4"-20 SHIELD
TEXTRON-LYCOMING		
VO-435-A, B (Long Reach) TVO-435-A, B, C, D, E, F, G, (Long Reach) O-435-23-25	REB37E RHB32E	RHB37E RHB32E
GO-480-B, D, F	REM40E REM38E	RHM40E RHM38E
GO-480-C, G (Short Reach)	REM38E	RHM38E
GO-480-G1, G2 (Long Reach)	REB37E	RHB37E RHB32E
GSO-480-A, B (Short Reach)	REM38E	RHM38E
GSO-480-A, B (Long Reach)	REB37E	RHB37E
IGSO-480-A (Short Reach)	REB38E	RHM38E
IGSO-480-A (Long Reach) IGO-480-A, O-480-1-3	REB37E REB32E	RHB37E RHB32E
O-540-A, D, E, F, G, H, J, J3A5; O-540-B; IO-540-A, B, E, G, K, L, M, P, S, U (Short Reach); IO-540-C, D, J, N, T, V; AEIO-540-D, L	REM40E REM38E	RHM40E RHM38E
IO-540-AA, E, G, J, K, M, P, R, S, U; O-540-L3C5D, M1B5D (Long Reach)	REB37E REB32E	RHB37E RHB32E
VO-540-A, B, C (Short Reach)	REM38E	RHM38E
O-540-9, VO-540-Series IVO-540-Series (Long Reach)	REB37E	RHB37E
IGO-540-A, -B (Short Reach)	REM38E	RHM38E
IGO-540-A, -B (Long Reach) TIO-540-A, C, E, F, G, H, J, K, N, R, S, T	REB37E	RHB37E
TVO-540-A	REB32E	RHB32E
IGSO-540-B (Short Reach)	REM38E	RHM38E
IGO-540-A, B	REB37E	RHB37E
IGSO-540-A, B (Long Reach)	REB32E	RHB32E
LTO-540-F, J, N, R TIO-541-A, E TIGO-541-A, E	REB37E REB32E	RHB37E RHB32E
IO-580-A		RHB37E
R-680	REM40E	RHM40E
IO-720-A, B, C, D (Short Reach)	REM38E	RHM38E
IO-720-A, B, C, D (Long Reach)	REB37E REB32E	RHB37E RHB32E
PRATT & WHITNEY		
R-985 (Wasp Jr.), R-1340 (Wasp)	REM37BY* REM40E	RHM40E
R-1830 (Twin Wasp C)	REB37E	RHB37E
R-2000 (Twin Wasp D)	REB37E	RHB37E
R-2800 (Double Wasp), R-2800-97, C3, CA5, CA15, CA17, CA18, CA19	REB37E REB32E	RHB37E RHB32E
R-4360 (Wasp Major)	REB37E	RHB37E
RANGER (all 18MM Short Reach)		
	REM40E	RHM40E
WARNER (all types)		
	REM40E	RHM40E
WRIGHT AERONAUTICAL		
R-540 Whitwind R-760, R-975 (1/2" Rch.) Cyclone 9N with 1/2" insert (R-1820)	REM40E	RHM40E
Whitwind R-760, R-975 (1 8mm 13/16") Cyclone R-1300 Cyclone R-1820 Series (except F & HE) Cyclone R-2600 Series	REB37E	RHB37E
Cyclone R-1820-84 (C9HE Series)		RHB32E
Cyclone R-3350, C18BA, C18BD	REB37E	RHB37E
Cyclone R-3350-C18CB1 Cyclone R-3350-DA1, 2, 3, 4, EA1, 2, 3 Cyclone R-3350-EA4, 5, 6		RHB29E

ENGINE MODEL	5/8"-24 SHIELD	3/4"-20 SHIELD	ENGINE MODEL	5/8"-24 SHIELD	3/4"-20 SHIELD
ALLISON			FRANKLIN ENGINE CO. (continued)		
V-1710	REB37E	RHB37E	6AS-335-A, B; 6AS-350-A, A1; 6V335-A1A, A1B	REB37E	RHB32E RHB37E
TELEDYNE-CONTINENTAL			6VS-335-A, B	REB37E REB32E	RHB37E RHB32E
A-65, A-75, C-75, C-85, C-90, C-115, C-125	REM37BY* REM40E	RHM40E	6A-350-C1, C1A, C2, C2A, D, D1; 6V-350-A, -B		RHB32E
E-165, E-185, E-225	REM40E	RHM40E	GYPSY MAJOR (all types)		
O-200-A, -B, -C	REM37BY* REM40E	RHM40E	JACOBS		
IO-240	REM38E	RHM38E	L-4, L-5, & L-6 series R-755	REM40E	RHM40E
GO-300-A, B, C, D, E, F O-300-A, B, C, D, E, C-145	REM37BY* REM40E REM38E	RHM40R RHM38E	R755S, R-755SM	REM38E	
IO-346-A, -B	REM40E REM38E	RHM40E RHM38E	KENROYCE-REARWIN (all types)		
IO-360-A, AB, C, CB, D, E, G, GB, H, HB, J, JB, K, KB; TSO-360-A, AB, B, C, CB, D, DB, E, EB, F, FB, G, GB, H, HB, JG, K, KB, LB, MB; LTSIO-360-E, EB, K, KB	REM38E	RHM38E	TEXTRON-LYCOMING		
IO-360-B	REM40E	RHM40E	O-235-C, E, H O-235-K, L, M, N, P O-290 series	REM40E REM38E REM37BY*	RHM40E
O-470-2	REM38E	RHM38E	O-320-A, C, E; O-320-B, D, H AIO-320; LIO-320-B; IO-320-B, C, D AEIO-320-A, B, C, D	REM37BY* REM40E REM38E	RHM40E
O-470-4, 11, 13, 13A, 15, O-470-A, E, J, K, L, R, S	REM40E	RHM40E	IO-320-A, D, E	REM37BY* REM40E	RHM38E
O-470-B, G, H, M, N, P	REM40E REM38E	RHM40E RHM38E	AEIO-320-E IO-320-C, F; LIO-320-C (Long Reach)	REM37BY* REB37E	RHM40E RHM37E
O-470-T, U		RHB32E	O-340-A	REM40E REM38E	RHM40E RHM38E
IO-470-C, G, P, R, T	REM40E REM38E	RHM40E RHM38E	O-340-B	REM40E	RHM40E
IO-470-J, K	REM40E	RHM40E	O-360-A, C, E, F IO-360-B, E, F, H, L AEIO-360-B, C, H; HO-360-A	REM38E REM37BY*	RHM40E RHM38E
IO-470-D, E, F, H, L, M, N, S, U, V, VO, LO; GIO-470-A		RHB32E	O-360-B, D	REM40E REM37BY*	RHM40E
LIO-470-A	REM40E REM38E	RHM40E RHM38E	IO-360-A, C, D, J; LIO-360-E	REM38E REM37BY*	RHM38E
TSIO-470-B, C, D		RHB32E	LO-360-A1A6D; O-360-E1A6D LO-360-C	REM40E REM38E REM37BY*	RHM40E RHM38E
IO-520-A, B, BA, BB, C, CB, D, E, F, J, K, L, M, Mb, N, NB		RHB32E	IO-360-A, IO-360-C1F IO-360-F (Long Reach) IO-360	REB37E	RHB37E
TSIO-520-A, B, BB, BE, C, CE, D, DB, E, EB, F, G, H, J, JB, K, KB, L, M, N, NB, P, R, T, U, UB, V, VB, WB, AE, AF; LTSIO-520-AE		RHB32E	AIO-360-A LIO-360-C; AEIO-360-A	REM38E REM37BY*	RHM38E
GTSIO-520-C, D, E, F, G, H, K, L, M, N		RHB32E	HIO-360-A, D	REM38E	RHM38E
TSIO-550-A, B, C; IO-550-A, B, C, D, E, F, G, L, N, P, R		RHB32E	HO-360-B; HIO-360-A, B	REM40E REM38E	RHM40E RHM38E
W-670	REM40E	RHM40E	TIO-360-A, B; AEIO-360-A (Long Reach)	REB37E	RHB37E
R9A	REB37E	RHB37E	HIO-360-E1AD, E1BD, F1AD LHIO-360-F1AD; IO-360-A	REB32E	RHB32E
FRANKLIN ENGINE CO.			TO-360-A1A6D, C1A6D, E, F1A6D LIO-360-A1A6D, E	REB37E	RHB37E RHB32E
2A4 Series	REJ38		VO-360-A, B	REM40E REM38E	RHM40E RHM38E
2A-120-A, B		RHB32E	O-435-A, C O-435-K, K1	REM40E REM38E	RHM40E
4A4 Series, 4AC Series	REJ38		GO-435-C, D Series VO-435-A; TVO-435-A (Short Reach)	REM38E	RHM38E
4A-235-B, B3, Sport 4, 4A, 4A1, 4B, 4R		RHB32E			
6AC, 6AL, 6AG, 6AA, 6VA Series	REJ38				
6A4-200, 6V4-200, 6V6-245	REL37B				
6A8-215	REJ38				
6A-335-A, B, 6V335-A, -B	REL37B				

Not a complete list. Visit our website at www.aircraft-tool.com for complete listing

* Use REM37BY when encountering lead fouling.





PROPELLER SHAFT OIL SEAL INSTALLER



For all propeller flange shafts per Continental Bulletin M-70-2. Also fits Lycoming. For installing one piece stretch seals easily and efficiently without damaging the seal or crankshaft.

5209.....\$89.95

PUSH ROD SPRING COMPRESSOR



For compressing and holding push rod springs on all engines with spring loaded tubes. Compresses the spring, which can then be removed with the clips furnished. Eliminates wiring springs together. To install, simply insert spring, then pull off the clip. Instructions included.

68-3\$499.95

PUSH ROD FLARING TOOL



Expansion type flaring tool produces a perfect housing flare every time. Balls rotate inside the push rod housing tube, and snugly expands it into the boss.

4915A\$99.95

VALVE TAPPET CLEARANCE GAUGE



These tools do the same job as the comparable Lycoming or Continental product which sells for well over \$150. The blades are ground and polished to precisely .080" and .028" respectively for Lycoming, and .060 and .200" for Continental.

T23S (Lycoming)\$65.95

VALVE SPRING COMPRESSOR

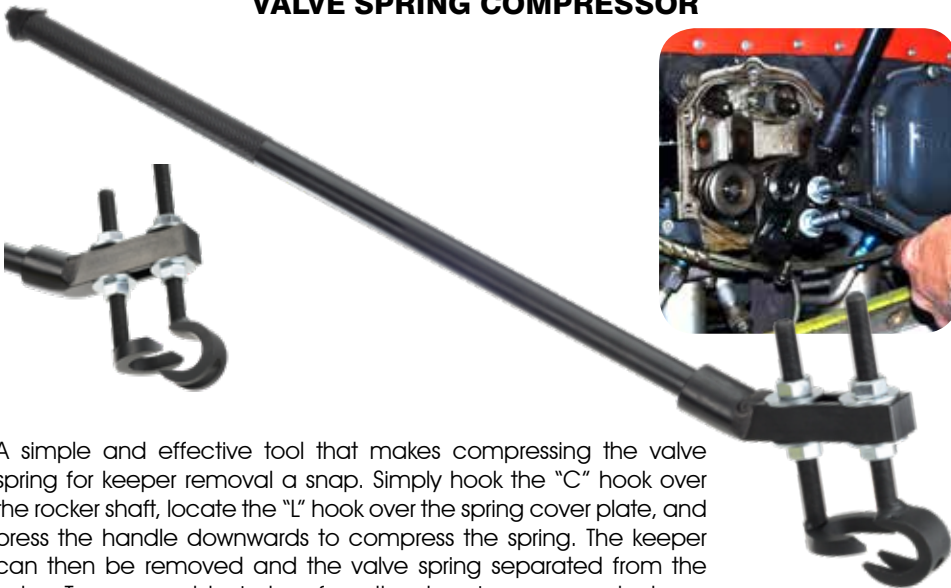

A simple and effective tool that makes compressing the valve spring for keeper removal a snap. Simply hook the "C" hook over the rocker shaft, locate the "L" hook over the spring cover plate, and press the handle downwards to compress the spring. The keeper can then be removed and the valve spring separated from the valve. To re-assemble, just perform the steps in reverse order to re-install the keeper. It's that simple.

3602.....\$179.95

HARTZELL PROPELLER WRENCH



Hartzell prop installation requires a special wrench to torque the nuts on the prop hub. Hartzell sells a similar wrench for over \$200 list price. Made from heat treated 4130 steel and laser cut to fit 3/4" nuts and 1/2" drive torque wrench. For use on Hartzell props on Lycoming O360 engines.

AE3528.....\$71.95

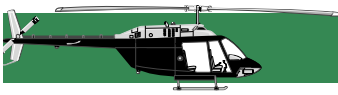

ENGINE EQUIPMENT

OIL FILTER MEDIA CUTTER



This innovative Oil Filter Media Cutter allows the filter media to be cut, removed and analyzed in a very neat and orderly fashion. It's design greatly reduces the chance of accidentally injuring yourself. A pivoting knife with a retractable safety blade is brought into position to make a clean, consistent cut of the filter media. And once cut, the media can be removed for inspection and evaluation. Other benefits are time-saving and a filter sample with no contamination compared with other cutting methods. Works with all Champion filters, and can be adapted for use with Kelly and Tempest Filters.

- FMC-2010** (Portable Unit) **\$209.95**
- FMC-2000** (Bench Unit with Stand) **\$351.95**
- FMC-2000K** (Kelly Aerospace Adapter Kit) **\$106.95**
- FMC-2000T** (Tempest Adapter Kit) **\$106.95**
- FMC-2000BL** (Replacement Cutting Blade) **\$13.95**

OIL FILTER CAN HOLDER



Cutting open an oil filter can be a messy process, but this oil filter can holder makes easy work of it by containing spills that might occur during the cutting process. It's made from solid CNC machined aluminum to hold up to heavy use. And it features three locking pins to puncture and securely hold the can in place prior to cutting. The holder also reduces side loads on the cutter blade (from the FC2000), allowing for a more precise cut with less can deformation. It's simple to use and easily locks into any machine vise. It's a great accessory to the FC2000 Oil Filter Cutter.

- FH-2000** **\$100.95**

HEAVY DUTY OIL FILTER CUTTER



Heavy duty oil filter cutter opens any spin-on type oil filter quickly and efficiently, including the new Champion dash 1 series with the heavier base. This is a complete tool with no parts or adapters to change. It centers around the filter quickly, with no parts to change, and cuts in either direction. Cuts all Champion 3.7 Inch diameter filters. Also cuts the new Champion RBC308 filter used on the Rotax 912 and 914 engines.

- FC-2000** (For Filters up to 3.7" Diameter) **\$93.95**
- FC-3000** (For Filters from 3.7" to 4.7" Diameter) **\$107.95**
- CT470-4** (Replacement Cutter Wheel) **\$13.95**

AIRWOLF OIL FILTER CUTTER



The Airwolf Oil Filter Cutter's unique design makes it a snap to cut through any type of oil filter. It's machined from solid 6061-T6 Aircraft-Grade Aluminum and fitted with stainless steel rollers for smooth cutting. The high carbon steel cutting blade is hardened to 60 Rockwell and honed to razor sharpness to produce clean, consistent cuts. Every mechanic knows that an oil filter cutter is an essential tool; and if you demand the best, then the Airwolf is for you.

- AFC470** **\$112.95**
- AFC470-RB** (Replacement Blade) **\$8.95**

OIL FILTER CUTTER



Works on all oil filters. Cuts open oil filter for inspection without introducing chips.

- 1154** **\$146.95**
- 1154-1** (Replacement Cutter) **\$16.95**



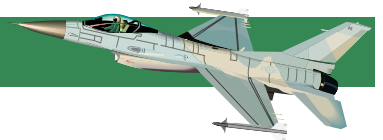

TOM'S OIL FILTER CUTTER



Tom's Oil Filter Cutter offers a new approach to the essential task of opening your oil filter for inspection. This product cuts the filter easily in one pass. Includes adapter to work with any type of Champion or Tempest aviation filter. May also be used on smaller filters such as those found on Rotax or automotive engines.

154701 **\$58.95**

OILEASY OIL FILTER WRENCH



The "Oil Easy Wrench" is specifically designed to remove the oil filter on any aircraft using the Continental IO-520, or IO-550 engine. It's the only wrench that can get between the top of the oil filter and the pressure pump and still provide enough leverage to remove the old (usually stuck) oil filter by hand.

OILEASY1 **\$48.95**

KLUHSMAN OIL FILTER CUTTER



This economical cutter quickly opens any size oil filter canisters for filter inspection. Simply place the filter in a vise, attach the tool to the top, and rotate about 4 to 6 turns to cleanly cut open the canister. It's made of high quality 6061 aluminum with an attractive purple anodized finish. The cutting wheel stays sharp for up to 45 applications, and is easily replaced when it becomes dull.

FC01 **\$65.95**

FCW (Replacement Cutting Wheel) **\$8.95**

OIL NUT WRENCH



This wrench is specially designed to comply with CESSNA AD 96-12-22

The Oil Nut Wrench allows you to reach the adapter nut, which must be torqued to a value of 50 to 60 foot pounds in accordance with the CESSNA AD. Its use is required every time the oil filter is removed to prevent the possible loss of engine oil caused by loose or separated adapters. This tool is absolutely essential for anyone working on any of the following aircraft: All Cessna Models 100, 200, 300, and 400 series; Meyers 200; Twin Commander 500A and 685; Beech 33, 35, 36 and 55 series; Piper PA 46; Navion Rangemaster 17 series; Wren Model 460; Bellanca 200 and 300 series.

TG961222 **\$79.95**

AVERY TOOLS OIL FILTER CUTTER



This tool allows you to easily cut open your oil filter to inspect the paper filter element for contaminants and to detect problems inside your engine before they become major and expensive issues. This oil filter cutter will work with both styles of aircraft oil filters -- those that have female threads and those that have male threads. This tool will cut filters from 3" diameter up to 4-3/4" diameter.

AE81031 **\$94.95**

AE12027 (Replacement Blade) **\$9.95**

OIL FILTER TORQUE WRENCH



A Professional Quality, Heavy Duty wrench with a built in ratcheting mechanism and a pre-set torque arm. The tool fits all standard general aviation aircraft oil filters and has a solid lever-arm with a knurled grip to make oil filter removal a snap! The wrench is compact for areas of limited access and easily fits filters in tightly cowled aircraft. Once the new filter is ready for installation, reverse the wrench and ratchet the filter securely back into place. When the pre-set torque limit of 17 ft/lbs is reached, the user will feel a slight "break" or "click" in the handle. No other torque tools are required.

AA472 **\$59.95**

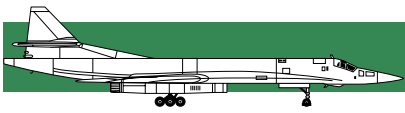

ENGINE EQUIPMENT

AVIATION PISTON RING COMPRESSOR



Our Aviation Piston Ring Compressor features a quick-change design to speed up piston ring installation. It includes the famous Hastings Ring-O-Matic® pliers and bands that operate in all positions: not just vertically or horizontally.

PART	DESCRIPTION	PRICE
1670A	Ring-O-Matic Pliers	\$39.95
1670F	Band 3-7/8" to 4-1/8"	\$21.95
1670G	Band 4-1/8" to 4-3/8"	\$21.95
1670H	Band 4-1/2" to 4-3/4"	\$24.95
1670I	Band 4-3/4" to 5"	\$24.95
1670J	Band 5" to 5-1/4"	\$24.95
1670K	Band 5-1/4" to 5-1/2"	\$24.95
1670L	Band 5-1/2" to 5-3/4"	\$31.95
7500	Complete kit with pliers and bands for sizes 4-1/8" to 5-3/4"	\$179.95

SMALL BORE PISTON RING COMPRESSOR KIT



This kit is designed to accommodate engines with smaller cylinder bores. It features the same Hastings Ring-O-Matic® pliers as the Aviation Kit, so you can easily purchase additional bands as needed. The kit includes pliers and 6 bands in the following sizes: 2-7/8" to 3-1/8", 3-1/8" to 3-3/8", 3-3/8" to 3-5/8", 3-5/8" to 3-7/8", 3-7/8" to 4-1/8", and 4-1/8" to 4-3/8".

1670.....\$99.95

WRINKLE BAND PISTON RING COMPRESSOR



An economical alternative to standard pliers and bands, this tool will do a great job of installing piston rings of any diameter up to and including 5".

- Wrinkle band cuts friction in half. Ring slides in easily.
- Wrinkle Band can't slip down into cylinder.
- Set adjustment screw just once for the entire set of pistons.
- Faster! Insert a full set of piston rings in half the time with half the work!
- Installs rings from 3" (76.2mm) to 5" (127mm).

21700.....\$13.95

PISTON RING INSTALLER AND EXPANDER



This important tool is inexpensive and easy to use. Just insert the ring ends in wedge jaws and expand the ring gently and slip into groove. Also ideal for removing rings easily without damage. Handles piston rings from 3/64" to 1/4" wide.

1723.....\$12.95

PISTON RING GROOVE CLEANER



Cleans carbon from piston ring grooves. Easily adjustable. Blades included for five most popular piston groove sizes: 5/64", 3/32", 1/8", 5/32", 3/16". Adjustable ratchet action holds piston in position during cleaning.

Revolve tool around piston to clean. Spring release for quick removal of piston.

2477.....\$24.95



VACUUM AND FUEL PUMP TESTER

Easy reading gauge assures accurate vacuum and pressure check. Has both English and Metric scales and measures vacuum from 0 to 30. The pressure gauge reads from 0 to 15 psi in increments of 1 psi.



20300.....\$28.95

RAPCO VACUUM PUMP WRENCH

This wrench is used to remove and replace vacuum pump flange nuts. The shank is bent to access those tight areas between the pump and the accessories nearby. The open end head is laser cut to provide a close tolerance fit on the nut.

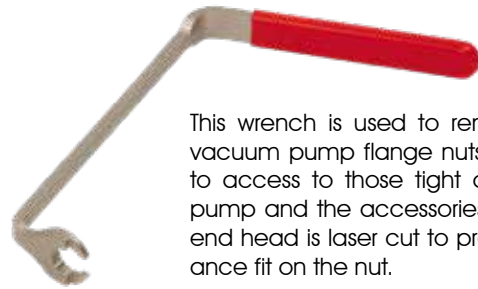

RA716.....\$34.95

LOCTITE® AVIATION GASKET SEALANT



A reliable liquid gasket sealant, dressing and coating compound. It brushes on very thinly and forms seals that resist temperatures of -65° to 400°F (-54°C to 204°C). It's resistant to gasoline, oils, and other solvents and is inert so that it will not interact with other chemicals. It dries to full strength in just under 12 hours. 1 pint container.

3051.....\$16.95

GASKET PUNCH SET

Punches holes in gasket material, leather, vinyl or soft material. Set of ten punches 1/4", 5/16", 3/8", 7/16", 1/2", 9/16", 5/8", 3/4", 7/8", and 1" with driving mandrel and molded plastic case.



S1270.....\$35.95

UNIVERSAL BEARING PACKER



Fast, efficient, thorough. Simply place the bearing between the plastic cones, tighten, and apply grease through the fitting on the end of the threaded shaft. Forces out old grease and evenly injects fresh grease into the bearing. Cone diameter is 5".

65250.....\$10.95

SEAL DRIVER KIT

Quickly drives seals without damage to the surrounding fixture. Comes complete with 16 adapters for seals up to 3-3/8" diameter. Includes a special adapter for "shielded" seals.



24800.....\$40.95

HANDY PACKER® BEARING PACKER



The Handy Packer works on bearings up to 3 1/2" O.D. The grease stays in the tool cavity, not on your hands. To pack a bearing, place the bearing on the piston. Press down on the cap until the old grease is forced out and the new grease shows on top of the bearing.

34550.....\$23.95

SEAL PULLER



Two hook sizes easily remove most oil and grease seals. Where clearance is a problem, remove the pin to reposition the head. The adjustable head works great in tight areas.

56650.....(Adjustable).....\$15.95

56750.....(Fixed).....\$8.95



ENGINE EQUIPMENT

VALVE LAPPING COMPOUND

Clover lapping compound is the choice of leading mechanics whenever they need to size valve stems and seats to exact tolerances, while producing an exceptionally smooth finish. Grease type mix retains its texture and lubrication properties during extended lapping or grinding and leaves a rust preventing film. 1lb. can.



A51803 **\$38.95**

VALVE LAPPERS



Excellent tool for restoring a valve's surface finish. Hand operated action allows you to remove metal in precise amounts. Each lapping tool comes with cups for two different valve sizes. Get both tools and you will be able to handle just about any type of engine.

21100.....(Sizes: 1-1/8" and 1-3/8") **\$9.95**
21200.....(Sizes: 5/8" and 13/16")..... **\$8.95**

MITYVAC VACUUM TESTER KIT

This is the original Mityvac hand vacuum pump kit used by service professionals worldwide for performing hundreds of automotive diagnostic and mechanical tests and for one-person brake bleeding. The MV8000 kit contains our most popular Selectline vacuum.



8000..... (Selectline tester kit) **\$49.95**
4000..... (Silverline Premium all-metal tester kit)..... **\$89.95**

HEAT RESISTANT ARM GLOVES



The heat resistant Kevlar® material protects hands and arms from hot surfaces. This enables work on hot engines and exhaust systems without waiting. Works on both right and left hands. The glove portion is coated with a vinyl tread for greater gripping power. Extends to 24". Washable.

21260.....(Arm Glove)..... **\$20.95**
18700.....(Hot Sleeve)..... **\$14.95**

CYLINDER FLEX-HONE



For cylinder bore reconditioning. 120 grit silicon carbide provides proper finish for cylinder wall breaking without expensive fixtures.

PART	SIZE	PRICE
102	3-1/2" to 4"	\$83.95
202	3-3/4" to 4-1/4"	\$89.95
305	4" to 4-1/2"	\$85.95
405	4-1/2" to 5"	\$93.95
505	5" to 5-1/2"	\$99.95
605	5-1/2" to 6"	\$109.95

VALVE GUIDE FLEX-HONES



Flex-Hone allows you to precision fit valve stems to proper guide tolerances. Flex-Hone is self aligning to the guide bore and self compensating for hone wear. Provides a plateau finish, which creates proper lubrication to prevent sticking and permits a closer stem to guide clearance. Hones are 240 S/C grit.

PART	SIZE	PRICE	PART	SIZE	PRICE
GB9	.354"	\$15.95	GB12	.472"	\$15.95
GB95	.375"	\$15.95	GB125	.500"	\$15.95
GB10	.395"	\$17.95	GB58	.625"	\$17.95
GB11	.433"	\$17.95	GB34	.750"	\$17.95

FORM-A-FUNNEL

Shape, drain, pour, store. Its that easy with the Form-A-Funnel Flexible Draining Tool. It guides oil around skid plates and cross members right into your oil drain for easy, no-mess oil changes! This tool quickly bends, molds and holds any shape, so you can customize the perfect channel to drain liquids without making a mess.



18609..... (14.5"L x 6.5"W Automotive) **\$20.95**
18611..... (29"L x 5"W Aviation)..... **\$29.95**



ATS AIRCRAFT ENGINE STAND KIT (WITH LOCKING CASTERS)



"This is a great product, is well made, easy to put together, and is very sturdy. It was obviously designed by mechanics as the hardware is correct in length etc..." ~ T. LeBaron



- Bolts together in minutes using just a 1/2" wrench.
- No Welding necessary.
- Supports over 1,200 lbs.
- Ships as a regular sized package, not oversized or dim weight.



65530-20SA

Our new breakdown Engine Stand Kit comes to you unassembled to save you **BIG** on shipping costs, but goes together in just a few minutes with only a couple of wrenches. Other engine stands are pre-welded and shipping via UPS or FEDEX can be very expensive because of their size and shape. In fact, it's not unusual for us to see shipping costs as high as \$375 to places in Alaska! Some of our competitors try to get around this by selling their engine stands in kit form, which solves the shipping problem. But you still have to weld it together yourself! So if you don't have welding equipment, or your welding skills are rusty, then you're out of luck. Our new engine stand requires ABSOLUTELY NO WELDING. We ship it in a compact box to minimize shipping costs, and provide everything you need to get going. All you need to supply are a couple of 1/2" wrenches and a little elbow grease.

65530CX.....(Complete Kit) \$269.95
 65530-20SA..... (Optional #20 Spline Adapter)..... \$175.95

EXHAUST STUD REPLACER KIT



A precision tool that will allow you to remove broken studs, retap, and replace them accurately to the original dimensions. This can be accomplished in most cases without removing the cylinder; even the Number One cylinder in a Bonanza. Works on all Continental 470, 540, 550, and 520 series engines. The kit includes the following: One steel, jig bored, locating plate; Three knurled retaining nuts to secure the locating plate; Four hardened and ground drill bushings; Three drill extensions - 6", 9", and 12"; One 3/8" drill chuck

HE01..... \$358.95

TOPCAP ENGINE PROTECTOR



The Topcap engine protector is made to fit over the cylinder studs and shield the inside of your engine while maintenance is being performed. Topcap engine protectors are used by leading mechanics everywhere.

- Fits most engines including Lycoming Wide Deck 320, 360, 540, 720, and Continental 470, 520, and 550 series engines.
- Allows for full crankshaft rotation.
- Made of fuel and solvent resistant polymer.

TC320.....(1 Pair)..... \$29.95



ENGINE EQUIPMENT

CONTINENTAL 550 CYLINDER BASE WRENCH



This 9/16" wrench is designed for easy access to nuts on the 550 series engines. Standard 1/2" square drive. 13" overall length. This wrench is also used on the 7th order stud of the GTSIO520BA.

8158A\$499.95

CONTINENTAL 470/520 MOUNT AREA WRENCHES



The special configuration of these wrenches permits access to the 470 and 520 engine mount areas. The 5203A wrench is specially designed for the 520 D&H engine's 3 and 6 cylinders.

PART	DESCRIPTION	SIZE	PRICE
5203	Left mount area	5/8"	\$749.95
5204	Right mount area	5/8"	\$713.95
5203A	520D&H 3 & 4 cyl.	9/16"	\$720.95

ENGINE MOUNT INSTALLATION ALIGNMENT PINS



Alignment pins for use in installation of engine mounts on aircraft engines. Pins go in the holes ahead of bolts to help align everything without damaging the bolts. Pins are 7/16" diameter steel, and machined with a taper to a bullet nose on the smaller end.

AE282.....\$18.95

CONTINENTAL/LYCOMING CYLINDER BASE WRENCHES



Low Profile to clear fins

- Fits all Continental, most Lycoming, and many other types of aircraft engines.
- 15" (381mm) span fits around almost all aircraft cylinders.
- 0.14"(3.5mm) thin wall fits into tight areas.
- 12-point end fits both hex 12-point nuts.
- 1/2" square drive.

The new ATS 3882-series Cylinder Base Nut Wrenches are made from forged alloy steel, tempered, and hardened for maximum strength. They also have an industrial chrome plating to improve surface wear, and protect against rust and corrosion.

PART	SIZE	PRICE
3882-9/16	9/16"	\$34.95
3882-1/2	1/2"	\$34.95
3882-5/8	5/8"	\$34.95
3882-3/4	3/4"	\$34.95
3882-5	Set of all 4 sizes	\$135.95

LYCOMING NARROW DECK CYLINDER BASE WRENCHES



Superior quality wrench is specifically used with internal hex nuts on Lycoming engines. Drive end is 1/2".

PART	SIZE	PRICE
6494-2	1/2"	\$39.95
6494-3	3/8"	\$39.95
6494-SET	Set of both sizes	\$69.95





ATS 10X AIRCRAFT STRUT PUMP



"I highly recommend this company. This pump is well made, very good quality and a useful tool. Each pump lifts my nose strut on my Baron about 1/4", so it is very controllable." ~ R. Gawer

- Made from 6061-T6 Aluminum for lightweight durability
- Operates on 50 to 150 psi air pressure (100 psi recommended)
- Enhanced high pressure valve system rated at over 3,000 psi
- True 10X boost produces over 1,500 psi from 150 psi source
- Also works with Nitrogen delivery systems
- Safety "one-shot" system delivers pressure in controlled bursts
- 24" High Pressure Delivery Hose

Delivers up to 1,500 PSI of pressure to raise struts without the need for jacks. Safety one-shot air delivery system gives you maximum control over the entire process -- each stroke of the delivery valve injects a small shot of pressurized air into the strut so that you can raise it in controlled increments. Virtually zero chance of accidentally over-pressurizing and possibly damaging your struts.

675A **\$329.95**

STRUT SERVICING EQUIPMENT



Our kit contains all of the hardware you'll need to deliver nitrogen to tires and struts from a nitrogen bottle. It includes a regulator, gauges (input and delivery), shut off valve, 12' hose, and a strut coupler. There are two types to choose from: Low pressure for nose struts and high pressure for main struts. Bottle (input) pressure gauge ranges 0-4000 psi. Delivery pressure gauge ranges 0-500 psi for the low pressure model, and 0-2500 psi for the high pressure model. Does not include nitrogen bottle.

606.....(0-500 psi Delivery Pressure) **\$394.95**
607.....(0-2500 psi Delivery Pressure) **\$799.95**

DUAL RANGE TIRE PRESSURE GAUGE



Accurately measures tire pressure up to 300 psi in 5 psi increments. Dual calibrations; psi in black and kg/cm2 in red. Accurate to within 5%.

980400..... **\$45.95**

SCHRADER STRUT COUPLER

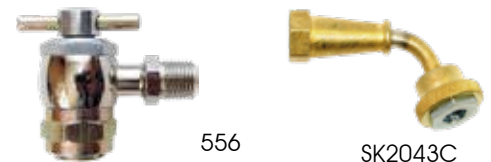

The Schrader Tee-coupler attaches directly to the strut valve to inflate or deflate the strut via the built-in core depressor pin.

The Schrader "gooseneck" coupler is used to connect to the inflation valves of most types of aircraft struts.

556..... Tee-Coupler **\$29.95**
SK2043C . Gooseneck Coupler **\$14.95**

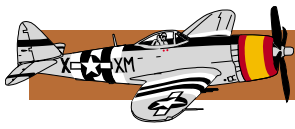

SERVICE & SUPPORT

PRESSURIZED STRUT FILLER



- One tank contains clean Strut fluid and the other collects the excess
- Built in pump forces fluid into the strut to top it off and the excess is drained off controlled right from the unit
- Large capacity 5 qt storage tanks are big enough for just about any strut
- Can be used on struts requiring up to 3000 psi strut pressure

Finally a real time and money saver! This tool changes the way landing gear struts are serviced. No longer do you have to put an aircraft up on jacks to add fluid to and fill Oleo type landing gear. This is a totally clean and safe process. No oil is spilled. The strut valve is not disturbed and the plane is sitting on the ground the whole time. This is safe for the technician and the aircraft.

BO-16M-PSF.....\$899.95



NEW



Scan to view video

15X STRUT PUMP



NEW

The 15X Strut Pump was designed for high pressure output. It is a pressure multiplier pump that is used to pressurize aircraft landing gear struts, and other high pressure applications. The 15X strut pump is able to boost air or nitrogen to 2250psi or 15 times the inlet pressure. Simply hook up the output hose to the strut and the inlet to a pressure source such as shop air or regulated nitrogen. Cycling the slide valve forces a single precise shot of high pressure air into the strut. Operator raises pressure in increments, maximizing control and minimizing chance of over-pressure. More than enough pump for most aircraft.

BO-19M-15X.....\$639.95

HX STRUT PUMP



NEW

Similar in size and weight to a standard bicycle pump, Bogert's Aviation's HX Strut Pump is designed for high pressure output. It is a portable hand pump that pressurizes landing gear struts. The HX strut pump boost air or nitrogen to 1000psi. Simply hook up the output hose to the strut and the inlet hose to an air compressor, spare tire, portable air tank or

12 volt tire inflator. For real back country use it even works with a bicycle tire pump. Very portable. No air compressor needed!

BO-19M-HX.....\$489.95

DELUXE STRUT SERVICE TOOL

The Deluxe Strut Service Tool is easier to use than the standard Strut Service Tool. Typically, the aircraft is placed on jacks. The SUPPLY TANK of the SST2 is partially filled with fluid. As the SST2 is attached to the strut, the pressure in the strut and any foam is released into the RETURN TANK.. The strut is compressed and extended several times until the discharge is all fluid. With the strut compressed, remove the SST2 and service with high pressure air or nitrogen.

BO-16M-SST2.....\$215.95

NEW





DELUXE BRAKE BLEEDER TANK



Our Deluxe Brake Bleeder Tank has been completely redesigned to resist the solvent effects of most types of aviation brake fluids. The high-impact plastic reservoir and specialized seals are compatible with 5606 and Skydrol. The hand operated pressurizing pump has also been totally re-engineered to deliver more pressure with fewer strokes. You will get everything needed to fit most brake receptacles.



"I spend hours trying to get the air out of my Piper Arrow brake system. After complete frustration, I decided to buy this pressure bleeder that fills the 5606 from the brake master cylinder (at the tires) and have the air bubbles rise to the brake fluid reservoir. My system was rock solid after only 20 minutes or so." ~ Pete VA.

225DX	(W/Both Adapters)	\$99.95
225DX-15H	(15' Extension Hose)	\$69.95
A255	(Universal Adapter)	\$8.95
1246	(Cleveland Adapter)	\$29.95

BRAKE RELINING TOOLS



Our W404 brake relining tool makes it virtually impossible to botch a brake relining job. The threaded screw action of the rivet insertion tool insures a perfect roll on brake rivets every time without damaging the liner. Machined steel, not cast.

W404	(Threaded Model)	\$29.95
W403	(Impact Model)	\$25.95
4-4	(Brake Relining Rivets)	\$6.95

AERO JACK SYSTEM



BO-30M-AJE

Forget bulky expensive wing jacks for simple projects! Reach for Bogert's Complete Aero Jack System. This kit includes Bogert Aviation's jack, extenders, and aero jack pads to save you time when servicing brakes, bearings or tire changes. The jack raises each wheel independently in seconds, makes servicing flat and round gear easy from one handy toolbox. Designed by an A&P, for do-it-yourselfers and professional aviation mechanics.

BO-30M-AJR	Round Tubular	\$283.95
BO-30M-AJF	Flat Gear	\$310.95
BO-30M-AJC	Aero Jack	\$409.95
BO-30M-AJE	Expandable Jack	\$1,280.95



BO-30M-AJC

AVIATION JACK



Be more productive with the Bogert Aviation Tribal Jack. It's easily 10X faster than wing jacks. Originally designed for the Piper Tribe of aircraft, Bogert's Tribal Jack has proven itself to be a great multipurpose shop tool for many aircraft models having oleo strut landing gear. The Tribal Jack is very useful for annual inspections as well as changing a tire or packing wheel bearings. Fixing a flat is easy with the 'new' lower clearance lifting pad. It can be used on main gear, nose gear and the tail wheel.

BO-30M-TJ	\$300.95
-----------------	----------



SERVICE & SUPPORT

MEYER HYDRAULICS® TRITASK AIRCRAFT JACKS



A500 SERIES



Ultra-low design is ideal for low-slung airplanes and helicopters weighing up to 8000 lbs. Features a 2.5" diameter slide tube and positive locks at 1" intervals. A 1.25" Jacking Point socket is built-in. NOTE: The optional AT500-CA conversion adapter allows this series to use AT-EBnnn Extension Bars for additional height.

PART	RANGE	CAPACITY (LBS)	PRICE
A514	14" to 24"	6000	\$995.95
A519	19" to 34"	6000	\$1,029.95
A521	21" to 38"	6000	\$1,049.95
OPTIONAL ITEMS			
AT500-CA	Conversion Adapter		\$54.95
AT400-204	Tube Extension 8" (A519 & A521)		\$45.95

A600 SERIES



This series is the standard Meyer Jacks for airplanes and helicopters weighing up to 8000 lbs. They have a 2.375" diameter slide tube with positive locks at 1" intervals. A 1" (25mm) diameter threaded hole at the top will receive a AT-JPRn Jacking Point Receiver, a Top-of-the-Jack Load Cell, or AT-EBnnn Extension Bars.

PART	RANGE	CAPACITY (LBS)	PRICE
A622	22.5" to 37.5"	6000	\$930.95
A627	27.5" to 47.5"	6000	\$996.95
A634	34.5" to 59.5"	6000	\$1,055.95
OPTIONAL ITEMS			
AT-EC01	Slide Tube, 28"-47" (A627)		\$155.95
AT62222	Slide Tube, 22.312"-37.312" (A622)		\$96.95
AT62234	Slide Tube, 34.312"-49.312" (A622)		\$97.95
AT62727	Slide Tube, 27.312"-47.312" (A627)		\$98.95
AT63434	Slide Tube, 34.312"-59.312" (A634)		\$111.95
AT63448	Slide Tube, 48.312"-73.312" (A634)		\$126.95
AJL-ZA	Extension Leg Set (4) (A634)		\$115.95
AJL-ZB	Extension Leg Set (8) (A634)		\$219.95

ACCESSORIES

PART	DESCRIPTION	PRICE
AT-JPR1	Jack Point Receiver #1, .187" x .875"	\$10.95
AT-JPR2	Jack Point Receiver #2, .375" x 1.25"	\$15.95
ALW-10	A500 & 600 Series Washer Set	\$35.95
AT-EBZA	Extension Bar Set	\$431.95
AT-EBZB	Extension Bar Set	\$439.95
ATS	Adjustable Tailstand 30" to 51.5"	\$244.95
ATS-AA72	Tailstand Slide Tube, 51" to 72"	\$94.95

A700 SERIES



This series is for heavier piston, jet powered, and turbo-prop aircraft weighing up to 32000 lbs. Features a 3.5" diameter slide tube with positive locks at 1.5" intervals. The top has a 1" (25mm) diameter threaded hole to receive a AT-JPRn Jacking Point Receiver, a Top-of-the-Jack Load Cell, or AT-EBnnn Extension Bars.

PART	RANGE	CAPACITY (LBS)	PRICE
A722B	22.5" to 36.5"	16000	\$1,810.95
A725B	25.5" to 42.5"	16000	\$1,829.95
A728B	28.5" to 48.5"	16000	\$1,849.95
A728C	28.5" to 48.5"	24000	\$2,025.95
A734B	34.5" to 60.5"	16000	\$1,850.95
A734C	34.5" to 60.5"	24000	\$2,045.95
A740C	40.5" to 71.5"	24000	\$2,035.95
A755C	55.5" to 95.5"	24000	\$2,559.95
A760A	60.5" to 100.5"	10000	\$2,239.95

TRITASK JACK SETS



TriTask Aircraft Jack Sets are designed to economically cover a wide range of airplanes and helicopters weighing up to 8000 lbs.

The Basic Set (pictured) contains: (2) A622 Jacks w/AT62222, (2) A634 Jacks w/AT63434, (4) AT-JPR1 Receivers, (1) AJL-ZB Extension Leg Set, (1) AT-EBZA Extension Bar Set, (2) AT62234 Slide Tubes, (2) AT63448 Slide Tubes, (1) ATS Tailstand

The Deluxe Set includes the Basic Set plus: (1) A622 Jack w/ AT62222, (1) AT-JPR1 Receiver, (1) ALW-10 Leveling Washer Set, (1) AT-EBZB Extension Bar Set, (1) AT62234 Slide Tube.

The Premium Set includes the Basic Set plus: (2) A627 Jacks w/ AT62727, (2) AT-JPR1 Receivers, (1) ALW-10 Leveling Washer Set, (1) AT-EBZB Extension Bar Set, (1) ATS-AA72 Slide Tube

A600JS-A..... (Basic Set)..... **\$5,195.95**
A600JS-B..... (Deluxe Set)..... **\$6,625.95**
A600JS-C..... (Premium Set)..... **\$7,695.95**

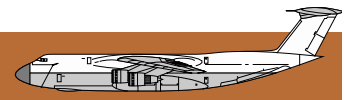

TRITASK JACK SELECTION GUIDE

Use the selection guide below to choose the correct TriTask jacks and accessories for your aircraft. If it's not listed, then measure the low and high jacking points of your aircraft and select the jacks that come closest to meeting your needs. Note: This table is only a partial listing for some of the more popular airplanes Meyer Jacks support.

Please visit us at www.aircraft-tool.com for a complete list.

AIRCRAFT	JACKS	REQUIRED ACCESSORY
Aero Comander 100	(2) A634	(2) AT63448, (2) AT-EBZA, (1) AJL-ZB, (1) ATS
Beechcraft: 1900, 99, King Air (all series)	(3) A734B	
Beechcraft: 95, Baron, Debonair, Bonanza	(2) A622	(2) AT-EB035, (1) ATS
Beechcraft: Bonanza Twin 50, Queen Air	(2) A634 & (1) A622	(1) AT62234
Beechcraft: Hawker 400, 400A Diamond, 700	(2) A728B & (1) A725B	(1) AT-EBZA
Beechcraft: Hawker 800's, 900's, 1000	(2) A728C & (1) A740C	(1) AT-EBZB
Beechcraft: Hawker 4000 Horizon	(3) A734C	
Beechcraft: Premier	(3) A728B	(1) AT-EBZA
Britten Norman: Islander/Trislander	(2) A634 & (1) A627	(1) AJL-ZB, (1) AT-EBZA, (2) AT63448, (1) ATS, (1) ATS-AA72
Bombardier: Challenger 300 Series	(2) A734C & (1) A728B	(1) AT-EBZA
Bombardier: Challenger 600 Series	(2) A734C & (1) A728C	(1) AT-EBZA
Bombardier: CL-215, CL-415	(2) A740C & (1) A728C	(1) AT-EBZA
Cessna: All High Wings except Caravan's	(2) A634	(2) AT63448, (1) AJL-ZB, (1) AT-EBZA, (1) ATS
Cessna: Caravans 208, 208B, 406	(2) A728B & (1) A622	(1) AT-EBZA
Cessna: 310, 320, 337 Skymaster, 340	(2) A634 & (1) A622	(1) AT-EB055, or (1) AT-EBZB
Cessna: All 400 Series except 406 Caravan II	(2) A634 & (1) A622	(1) AT-EB055, or (1) AT-EBZB
Cessna: Citation I 500, II 550, V 560	(2) A725B & (1) A722B	(1) AT-EBZB
Cessna: Citation CJ1, CJ2, CJ3 (525's)	(2) A725B & (1) A521	(1) AT-EBZA, (1) AT500-CA
Cessna: Citation V 560XL, 560XLS	(2) A728C & (1) A725B	(1) AT-EBZA
Cessna: Citation III 650, VI 650, VII 650	(2) A734B & (1) A725B	(1) AT-EBZB
Cessna: Citation 680 Sovereign	(2) A734C & (1) A734B	(1) AT-EBZA
Cessna: Citation X 750	(2) A740C & (1) A734B	(2) AT-EB015, (1) AT-EBZB
Cessna: Mustang 510	(3) A521	

AIRCRAFT	JACKS	REQUIRED ACCESSORY
Dassault: Falcon 10	(3) A728B	(1) AT-EBZA
Dassault: Falcon 20	(3) A734C	(1) AT-EBZB
Dassault: Falcon 50	(2) A740C & (1) A734C	(1) AT-EBZB
Eclipse: 500 (VLJ)	(2) A519 & (1) A627	(1) AT-EC01
Fairchild Swearingen: Merlin II, III, IV	(3) A740C	(1) AT-EBZA
Gulfstream: Aero Commander	(2) A634	(2) AT63448, (2) AT-EBZA, (1) AJL-ZB
Gulfstream: G100	(3) A734B	(1) AT-EBZB
Gulfstream: G150	(2) A734B & (1) A728B	(1) AT-EBZB
Gulfstream: G200 Galaxy	(2) A734C & (1) A728C	(1) AT-EBZA
Gulfstream: Turbo Commander	(2) A760A	
Jet Commander Westwind	(2) A734B	(1) AT-EBZB
Learjet: All 20's, 30's, 55	(2) A725B & (1) A722B	(1) AT-EBZB
Learjet: 45	(2) A728B & (1) A725B	(1) AT-EBZA
Learjet: 60, 70/75	(2) A728B & (1) A722B	(1) AT-EBZA
Lockheed: JetStar, JetStar II	(3) A734C	(1) AT-EBZB
Mitsubishi: MU-2's	(2) A760A & (1) A722B	(1) AT-EBZA
Mooney	(2) A622	(1) ATS
Navion	(2) A622	(2) AT-EB055, (1) ATS
North American Sabreliner	(3) A728B	(1) AT-EBZA
Pilatus: PC-9	(3) A728B	(1) AT-EBZA, (1) ATS (Pilatus jack point studs fit Jacks)
Pilatus: PC-12	(2) A728B & (1) A740C	(1) AT-EBZA (Pilatus jack point studs fit Jacks)
Piper: Aztec, Cherokee, Comanche, Seneca	(2) A622	(1) ATS
Piper: Aerostar & Chieftan	(2) A634	(1) ATS
Piper: Cheyenne II	(2) A734B	(1) ATS, (1) ATS-AA72
Piper: Cheyenne III	(3) A734B	(1) ATS, (1) ATS-AA72
Piper: Malibu PA-46	(2) A627	(1) AT-EBZB, (1) ATS
Piper: Navajo	(2) A634	(1) ATS
Piper: Saratoga	(2) A622 & (1) A627	(2) AT-EB055, (1) ATS, (1) ATS



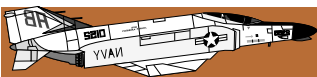

SERVICE & SUPPORT

ALPHA AVIATION AIRCRAFT JACKS

For over 12 years, family owned and operated Alpha Aviation has been making high quality aircraft jacks with the kind of craftsmanship and attention to detail that you just don't see in mass-market types. Each jack is hand fabricated, assembled, and thoroughly inspected to ensure that you will consistently receive the finest aircraft jack for your money. And with over 4,000 units in service since 1995, Alpha Aviation Jacks are field-proven to provide safe, rock-steady support for your airplane.

Find your jack: There are 5 models to cover just about every light aircraft. Locate your airplane in the chart below and select the appropriate jacks. Or if it's not listed, measure the height from the ground to your airplane's jack point and select jacks that are shorter, but with enough range and load capacity to safely lift your airplane. Need more details? Visit www.aircraft-tool.com and search for keyword "Alpha Aviation."

Alpha

aviation inc.

AIRCRAFT BUILDER	AIRCRAFT MODELS	JACK MODEL* (*Any of the indicated models will work)	REQ	TAIL STAND
AERO COMMANDER	Commander 112/114/115	326, 332, 838, 868	3	No
BEECH AIRCRAFT	Baron	326, 332, 838, 868	2	Yes
	Duke	324	3	No
	Bonanza BE33/35/36	324, 326, 332, 838, 868	2	Yes
	Debonair BE333	326, 332, 838, 868	2	Yes
	Duchess BE76	326, 332, 838, 868	2	Yes
	Musketeer BE23	326, 332, 838, 868	2	Yes
	Sierra BE23	332, 838, 868	2	Yes
	Sundowner BE23	326, 332	2	Yes
Travel Air BE95	326, 332, 838, 868	2	Yes	
BELLANCA	All Low Wing, including SUPER VIKING	324	2	Yes
CESSNA	Cessna 172/177/182/210	868, 868HLW	2	Yes
	Cessna 310/320	332, 838, 868, 838HLW	3-4	No
	Cessna 337 Skymaster	868, 838HLW	2	Yes
	Cessna 340/400 series	838, 868, 838HLW	3-4	No
GRUMMAN	Cheetah, Tiger	326, 332, 838, 868	2	Yes
MOONEY	Ovation, Acclaim	324, 326, 332, 838, 868	2	Yes
PIPER	Apache PA23	326, 332, 838, 868	2	Yes
	Arrow PA28R	326, 332, 838, 868	2	Yes
	Aztec PA23	838, 868	2	Yes
	Brave PA25	326, 332, 838, 868	2	Yes
	Cherokee PA28/PA32	326, 332, 838, 868	2	Yes
	Comanche PA24	324, 326, 332, 838, 868	2	Yes
	Lance PA32	326, 332, 838, 868	2	Yes
	Saratoga PA32	326, 332, 838, 868	2	Yes
	Seminole PA44	326, 332, 838, 868	2	Yes
	Seneca 1/11/111	326, 332, 838, 868	2	Yes
	Twin Comanche PA30/39	324, 326, 332, 838, 868	2	Yes
PART	DESCRIPTION	CAPACITY	RANGE	PRICE
AAJ-324	Low Wing Jack	3 Ton (6,000lbs)	24"-40"	\$311.95
AAJ-326	Low Wing Single & Light Twin Jack	3 Ton (6,000lbs)	26"-43"	\$311.95
AAJ-332	Low Wing Single & Light Twin Jack	3 Ton (6,000lbs)	26"-49"	\$351.95
AAJ-838HLW	High Lift Cylinder	8 Ton (16,000lbs)	32-63"	\$496.95
AAJ-838W	Universal Jack	8 Ton (16,000lbs)	26"-55"	\$440.95
AAJ-868HLW	High Lift Cylinder	8 Ton (16,000lbs)	32-93"	\$628.95
AAJ-868W	High Wing Universal Jack	8 Ton (16,000lbs)	26"-87"	\$584.95
AAJ-375	Tail Weight	----	17"-39"	\$271.95
AAJ-375EX	Tail Weight Extension	----	16"	\$33.95
AAJ-K1	All-in-one Kit will raise all of the airplanes listed above (except Bellancas and Beech Duke). Contains (2) AA-838 and (2) AA-868 Universal jacks, plus (1) AA-375 Tail Weight. This is your best value if you need to raise more than one type of airplane.			\$2,177.95



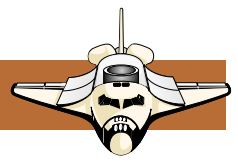

DESSER AIRCRAFT TIRE AND WHEEL BALANCER

This Wheel and Tire Balancer does what the Goodyear tire balancer does at a fraction of the cost. It will work with any assembly with at least a 1" axel up to 35" diameter tire.

- AS01.....\$419.95
- AS01-5W.....(5 oz Wgts- 5 pcs).....\$9.95

WHEEL BALANCER



McFarlane's wheel balancer uses the same static balancing method that is used to balance helicopter rotors. This design features a pivot point that is easily adjustable on-the-fly for maximum sensitivity, and includes bushings to accommodate 3/4", 1", 1-1/4", 1-1/8", 1-5/8" and 2" axle sizes.

- MA129.....\$305.95

TIRE BEAD BREAKER



This Tire Bead Breaker is capable of working on very small to very large tires and extremely adjustable! It will break the bead between the tire and wheel without doing damage to the expensive wheels.

- BO-13M-TBB.....(18"x16" Base).....\$216.95
- BO-13M-TBB2.....(28"x32" Base).....\$265.95
- AB-1.....(Meyer Brand).....\$258.95

TIRE BEADBUSTER



BeadBuster all-purpose tire bead breakers are small but mighty and will break the toughest tire beads! You know those hard-to-remove tires that are so frustrating? BeadBusters will break them in just a few steps. They employ a "clamp and ram" method that pushes down on the steel cord inside of the tire bead--not the sidewall like

conventional units--bringing the rest of the tire with it. These compact and lightweight tools are durable and easily portable making it a perfect toolbox item. And, no adjustment is needed for different tire/wheel sizes. Save time, money, and frustration by quickly and easily changing your own tires whenever, and wherever you want.

- XB-455.....(Standard).....\$99.95
- XB-550.....(Heavy Duty).....\$258.95

BEADBUSTER TIRE IRONS



If you want to change a tire, you'll need 2 things: A BeadBuster and this set of tire irons. The BeadBuster will break the bead from the rim, and the tire irons assist in getting the tires completely off. The unique curved shape of the large 15" lever has the perfect shape for reaching over the lip of the rim to start the job. The shorter levers are for working your way around the tire. These quality levers are a BeadBuster exclusive design. They are thicker and heavier than most tire irons you'll find elsewhere and are the perfect size for most tires.

- ACC-TL3.....\$35.95

TIRE MOUNT LUBE



Excellent for general purpose tire mounting and de-mounting applications. Our lubricant paste is designed to assist in mounting rubber tires and tubes on all types of wheels. It is fortified with rust inhibitors to provide protection against corrosion of the wheels. This mild formula is worker friendly, and can easily be diluted with water for a spray formula. Pack beads better than any other product due to its excellent adhesion, ultra thick consistency and the fact that it doesn't separate.

- ACC-TML.....\$19.95



SERVICE & SUPPORT

BOGERT AVIATION TOW BARS



More products available online

Bogert Aviation tow bars are built from steel for maximum durability and are chip resistant to look great for years. It is made with rubber grips on the handle and spreader bar for comfortable use. Light enough to stow on your airplane!

TAIL WHEEL		
PART	AIRCRAFT	PRICE
BO-04M-ABI	Alaskan Bushwheel	\$163.95
BO-04M-API	Aviation Products Tail Wheel	\$163.95
BO-04M-RV	Vans RV3, RV4, RV6, RV7, RV8, and RV9	\$163.95
BO-04M-TDG	Scott 3200 and 3400	\$163.95
BO-04M-XP	Cessna XP Modification	\$163.95
NOSE WHEEL		
PART	AIRCRAFT	PRICE
BO-04M-AIRGLAS	Airglas nose fork towbar	\$180.95
BO-04M-35	Beechcraft - Bonanza, Debonair, Duchess, Duke & Skipper, and Baron, T-34A, (Fits .25" Strut Pin)	\$163.95
BO-04M-19/23B	Beechcraft - Musketeer, Sport, Super, Sundowner & Sierra	\$163.95
BO-04M-B-90	Beechcraft -Twin Beech, King Air, Queen Air	\$163.95
BO-04M-172	Cessna 150, 152, 162 Skycatcher, 172, 175, 177, 182 Also RV-4	\$163.95
BO-04M-182-XL	Cessna 182 S (1996 and up) and T (2001 and up) models with long nose. Towbar extends to 55" and closes down to 35".	\$180.95
BO-04M-SR	Cirrus SR 20 & 22 Series	\$163.95
BO-04M-DA20	Diamond DA20	\$163.95
BO-04M-DA40	Diamond DA40	\$163.95
BO-04M-DA42	Diamond DA42	\$299.95
BO-04M-AA	AMD-CH-2000, Gulfstream American AA1 & AA5	\$163.95
BO-04M-LANDIS	Landis nose fork	\$180.95
BO-04M-MOON	Mooney aircraft	\$163.95
BO-04M-NAVION	Navion Aircraft towbar	\$163.95
BO-04M-24/30	Piper Comanche PA-24, PA-30 & PA-39 Also PA-32 Cherokee Six axle w/pants if tabs above wheel are broken. (Not verified for Piper Saratoga with fixed gear)	\$163.95
BO-04M-PA46	Piper Malibu, Meridian & Mirage - Hand Pull	\$299.95
BO-04M-28R	Piper PA-28R Series - Hand Pull for dog-leg style gear, also fits Saratoga/Lance Retractable, PA-46, Malibu, Mirage, Meridian	\$299.95
BO-04M-RV10	Vans - RV10, RV14A	\$163.95
BO-04M-RVA	Vans - RV6A, RV7A, RV8A, RV9A, & RV12	\$163.95

BOGERT AVIATION JACK PADS



- Rubber Padded
- 3/4" Ball jack point
- Jack Ram 1.25" Diameter
- Made in the USA

Follow aircraft service manual instructions for jacking

PART	AIRCRAFT	SINGLE / PAIRS	PRICE
BO-30M-B90	Beechcraft 90	Single	\$373.95
BO-30M-C210	Cessna 210, 177RG	Pairs	\$100.95
BO-30M-C300	Cessna 300, 400 & 500	Single	\$58.95
BO-30M-C337	Cessna 337 Series	Pairs	\$100.95
BO-30M-FPP	Cessna C-120, 140, 150, 170, 172, 175, 180, 185, 182, 188, 190, 195, 205, 206, 336, 337, flat gear 177RG, Piper Tomahawk, Beech Skipper, Champion, Bellanca, Diamond DA20/DA40 and similar spring steel landing gear.	Pairs	\$130.95
BO-30M-MO	Mooney M20 Series	Pairs	\$100.95
BO-30M-MUSK	Beechcraft Musketeer, Beechcraft Sundowner	Pairs	\$142.95
BO-30M-R	Cessna C-172RG, 177RG, 182RG, 210, T210, P210, and similar landing gear.	Single	\$100.95
BO-30M-RG	Cessna 182RG, 172RG	Pairs	\$100.95
BO-30M-RV	Fits RV aircraft that have a threaded tie down rings with 3/8-16 threads	Single	\$90.95
BO-30M-SR	Cirrus SR20, SR22	Pairs	\$100.95

Visit www.aircraft-tool.com for complete details on jack pads.

Two great ways to stay up to date on our expanding inventory!

1. Browse the "What's New" section on our website.
2. Sign up for our E-Blast at the bottom right.

View the complete listing online at www.aircraft-tool.com





SEAT RAIL WEAR GAUGE



For checking seat rail wear limits as per FAA Airworthiness Directive 2011-10-09, Effective 06/17/2011 Seat Rail Directive and its predecessor A.D. The gauge is used for inspection of seat rail wear in Cessna aircraft. It's designed to measure the actual radius wear near the seat stop holes. The size applies to the .42 diameter limits referred to by the A.D. The .020 upper surface wear allowance allowed by the A.D. is designed into the gauge.

SR1 \$43.95

PIPER TAPER PIN REMOVAL TOOL



Piper AD 2010-15-10 requires inspection of the connection between the control yoke universal joint and the shaft on the forward end of

the joint. This taper pin removal tool makes this job easy and safe even with the most stubborn taper pins. Simply position the tool on the u-joint and tighten the bolts until the pin breaks free.

MA107 \$82.95

HINGE BEARING TOOL KIT



- Seven piece kit for common bearing sizes
- Heat treated stainless steel will last a lifetime
- Kit comes in a convenient storage pouch

This unique tool is specifically designed to prevent damage when installing or removing sintered bronze elevator and rudder hinge bearings in Cessna aircraft.

MA990 \$75.95

DYKEM CROSS-CHECK™



DYKEM® Cross-Check™ is a convenient visual method for identification of vibratory loosening or tampering in nuts, bolts, fasteners, and assemblies. Marks will be easily broken if parts are tampered with or become loose. Highly visible marks. Excellent adhesion to metal and other substrates.

- 83314..... (Orange)..... \$6.95
- 83315..... (Green)..... \$6.95
- 83316..... (Red)..... \$6.95
- 83317..... (Yellow)..... \$6.95
- 83318..... (Blue)..... \$6.95

WEAR GAUGES



Airworthiness Directive AD2011-10-09 requires the inspection of the rollers, roller housings, seat rails, engagement pin and attaching hardware. In all, there are five measurements that are required for the pilot and copilot seat assemblies. These two tools will shorten the time to make these five compliance measurements to only two minutes! TOOL-A measures the pin engagement, roller tang width, and roller tang thickness, and TOOL-B measures the seat rail hole wear, and the opening of the roller housing tangs.

AD2011-10-09 \$46.95

CESSNA FLAP TRACK GAUGE/ INSTALLATION TOOL



MA950

MA970

Use the flap track gauge to quickly determine if your aircraft track guides are within tolerance. The installation tool holds parts in alignment while inserting the bolt for Cessna 150 thru 210.

MA950.....(Flap Trap Gauge)..... \$42.95

MA970.....(Installation Tool)..... \$40.95

FISH SCALES



NB6084

5A354

A fish scale is used to measure aircraft weights and forces such as control stick force, landing gear forces, and tail weight. Each scale is accurate to .5 lbs (8oz).

NB6084 (Digital, 0 to 150 lbs, .5 lbs accuracy) \$15.95

5A354 (Brass, 0 to 50 lbs, .5 lbs accuracy) \$129.95

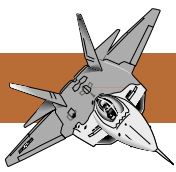

SERVICE & SUPPORT

MULTISUMP FUEL TESTER

23880



27810

- Stainless steel push rod
- One hand operation
- Quick-acting drain valve
- Clear construction
- Check up to 8 sumps
- No drip pour spout valve

Simply draw a sample from the sump and inspect it in the upper sampling cup. Transfer the fuel to the lower catch can by tipping the sample cup in any direction. The MultiSump can check up to 8 sumps before needing to be emptied. Optional fuel strainer snaps onto the bottom of the MultiSump and utilizes a micro-mesh stainless steel screen to keep impurities and water from entering the fuel tank during pour back.

- 23880.....(Fuel Tester).....\$26.95
 27810.....(Fuel Strainer).....\$9.95

WHEEL CHOCKS



These tire stops keep the aircraft securely parked. A pair of black molded plastic wheel stops are connected with a 22" bright yellow and black braided nylon rope that won't rot or retain water. The bottom cleats keep aircraft securely parked, and the concave design fits any aircraft tire. One pair is needed for each wheel.

- ASA-CHOCKS.....\$37.95

REMOVE BEFORE FLIGHT BANNER



A "remove before flight" streamer hangs off the cover as a prominent pre-flight reminder to pilots.

- PTC-34.....(Large 3/4").....\$14.95
 PTC-58.....(Small 5/8").....\$14.95
 PTC-B.....(Blade).....\$14.95
 ASA-RBF.....\$7.95

CARBON MONOXIDE DETECTOR



This Carbon Monoxide Detector can save a pilot's life, especially when flying with the heater on, by warning of the presence of CO in the cockpit—the spot will turn gray/black when CO is in the air. The spot on the detector returns to normal color after it is exposed to fresh air. Useful life is 90 days once opened. Not for use with Diesel engines.

- ASA-CO-D.....\$4.95

COMPASS SCREWDRIVERS

906



AE8505



These compass screwdrivers are totally non-magnetic. Strictly designed to adjust magnetic compasses or great for other applications where you need a small blade screwdriver.

- 906.....(ATS Brass).....\$9.95
 AE8505.....(Avery Stainless Steel).....\$10.95

FUEL TESTER



Protect yourself from fuel contamination by visually checking the fuel for water and debris. Fits all quick-drain valves and has an adapter for recessed drains. The transparent cylinder is 6" or 4" long with octane color-coding molded in the side. Also includes a screwdriver blade with both Phillips and slotted heads.

- AFT-1.....(6").....\$6.95
 AFT-SHORT.....(4").....\$6.95
 AFT-C.....(Cup).....\$5.95

CONTROL LOCK



Gusty winds will cause unsecured control surfaces to flail about and control sticks to thrash around inside the cockpit and most certainly will cause damage to your airplane if measures aren't taken to secure them. That's why this lightweight, space-saving control lock is for you. It will quickly lock the control stick in place, thus keeping your ailerons and elevators in a safe and firm position.

- DAS-CL100.....(General Aviation).....\$80.95
 DAS-CL100.....(Piper Sport).....\$80.95
 DAS-CL200.....(RV, Cessna, and Cub).....\$80.95
 DAS-CL230.....(RV12).....\$80.95





HOSE ASSEMBLY TOOL



These hose and fitting assembly mandrels are designed for all straight fittings in Aeroquip 303 and Stratoflex 111 series. These hose types are common to most hydraulic, pneumatic, coolant, fuel and oil systems specified in MS33620 for aircraft applications.

PART	HOSE SIZE	FITTING NUMBER	THREAD SIZE	PRICE
2701-3	-3	300-3	3/8-24	\$18.95
2701-4	-4	300-4	7/16-20	\$14.95
2701-5	-5	300-5	1/2-20	\$14.95
2701-6	-6	300-6	9/16-18	\$19.95
2701-8	-8	300-8	3/4-16	\$21.95
2701-10	-10	300-10	7/8-14	\$29.95
2701-12	-12	300-12	1-1/16-12	\$37.95
2701-KIT	All mandrels listed above plus case			\$155.95

THE TUBECUTTER™ HOSE CUTTER



The TubeCutter™ is guaranteed to produce a clean, square cut every time. It cuts through Aeroquip lines, rubber tubing, plastic tubing, hydraulic hoses, and pneumatic lines. It's so strong, it'll even cut through Kevlar reinforced hoses! Manufactured from drop forged steel and chrome plated for durability.

UG1234 **\$36.95**
UG1234-B..... (Rep Blade) **\$9.95**

ADEL CLAMP INSTALLER



These pliers make cushion clamp installation so easy that you will no longer dread the installation process. This tool securely and simply clamps the entire assembly together and leaves the hardware holes lined up. The mechanic is free to use both hands to fit the hardware.

SMA-101 **\$39.95**

AVERY ROD END BEARING ADJUSTING TOOL



Tool designed for installing and removing rod end bearings without damage to the bearing, when screwing rod end bearing into nut-plates. Tool puts the pressure on the housing - not the bearing. Precision machined tool has 2 different width slots (3/8" & 7/16" wide) machined in either end to match the (2) common sizes for rod end bearings (5/16-24 & 3/8-24) common to RV aircraft. Comes with drive handle.

AE408 **\$19.95**



SERVICE & SUPPORT

MINI-MIXER SEMKIT PACKAGE MIXER



The mini-mixer conveniently fits onto any air or electric drill with a 3/8" chuck and will work with both injection and barrier style packages. Use the mini-mixer to reduce fatigue and provide a more uniform mix than is possible by hand. The mini-mixer is tiny enough to fit into your shirt pocket, yet it will perform the same job as the larger industrial mixers.

MMX01 **\$24.95**

SEMCO® HOSE ASSEMBLY



All hose assemblies come with a B-nut fitting to attach to the Semco gun and the specified quick connect attachment. Each hose is 5 ft (1.5m) long.

PRC-5A.....(With **ARO Quick-Connect Fitting**)..... **\$39.95**
PRC-5H..... (With **HANSEN Quick-Connect Fitting**)..... **\$69.95**
PRC-5S (With **SCHRADER Quick-Connect Fitting**)..... **\$69.95**

PRC® DISPOSABLE CARTRIDGES AND NOZZLES



Semco disposable cartridges are molded from high density polyethylene, which makes them capable of handling a wide variety of chemical fluids for storage and application. Use them to load your own adhesives, sealants, lubricants, or other media.

PART	DESCRIPTION	PRICE
PRC-2PW	2.5 oz. Disposable cartridge	\$2.95
PRC-6PW	6 oz. Disposable cartridge	\$3.25
PRC-255N	2" nozzle, no orifice	\$2.15
PRC-415N	3-1/2" nozzle, no orifice	\$2.15
PRC-420N	3-1/2" nozzle with 1/16" orifice	\$2.15
PRC-430N	3-1/2" nozzle with 3/32" orifice	\$1.95
PRC-440N	3-1/2" nozzle with 1/8" orifice	\$2.15

SEMCO® AIR SEALANT GUN



The Semco air sealant gun is designed for the quiet, pneumatic application of sealants, adhesives, potting compounds, and other materials packaged in PRC® disposable cartridges. The gun is made of metal and plastic and is engineered to withstand the rigors of the production work place. The handle can be removed to allow more clearance and better manipulation in confined areas. Note: The air hoses required to operate Semco air sealant guns are sold separately.

PART	DESCRIPTION	PRICE
250A-2	Pistol grip gun with 2.5 oz. Metal retainer	\$400.95
250A-6	Pistol grip gun with 6 oz. Metal retainer	\$406.95
250-2R	2.5oz. metal retainer for 250 series dispensers	\$75.95
250-6R	6oz metal retainer for 250 series dispensers	\$82.95

SEMCO® MANUAL SEALANT GUN



The Semco model 850 gun is a hand-operated, high quality dispensing gun designed to accept Semco disposable cartridges or Semkit packages. It is excellent for the "in-field" application of sealants, adhesives, and other materials. A threaded retainer provides a tight fit into the ratchet handle, permitting uninterrupted operation.

PART	DESCRIPTION	PRICE
850-2	Manual Gun with 2.5 oz. Metal retainer	\$138.95
850-6	Manual Gun with 6 oz. Metal retainer	\$147.95
850-2R	2.5oz. metal retainer for 850 series dispensers	\$48.95
850-6R	6oz metal retainer for 850 series dispensers	\$53.95

SEMCO and SEMKIT are registered trademarks of PRC DeSoto International



ATS PRO TUBE BEADING KIT

The finest beading tool money can buy. We Guarantee it!



Makes perfect beads from 1/4" to 1"



Meets MILSPEC MS33660D and SAE AS5131 Standards

Looking for a tube beading kit that will last a lifetime? Yes, a lifetime! The Pro Tube Beading Kit carries the ATS Pro lifetime warranty guarantee. It is a kit that has been the number one choice of mechanics for making clamping beads in metal tubes.

For years, Aircraft Tool Supply was the sole supplier of these tools as a surplus product. Eventually supply exhausted, however customers insisted that they take the necessary steps to bring them back in stock.

In the process of recreating this classic tool, Aircraft Tool Supply added a few enhancements to further elevate this kit. The new improvements include ground, hardened, and polished surfaces for mar-free beads in aluminum, copper, brass, and mild steel tubes ranging from 1/4" to 1" in diameter.

Also available are our ATS Pro Mini Beading Kits (p/n TB145A series). They use the same components and have the same exceptional quality as the Pro Beading Kit. Each kit is designed to cover a set of commonly used sizes, and can be easily upgraded by adding more dies and frames as needed.

Here's my personal guarantee to you: Try our ATS Pro Beading Kit for 30 days and if you're not 100% satisfied, call me toll free at 1-800-248-0638 and I will personally make sure that you get a full refund including your shipping costs. No questions asked. -- Des Lynch, Owner



Scan to view video

PART	TUBE SIZES	PRICE
TB145A-1	1/4"	\$169.95
TB145A-2	3/8", 1/2", & 5/8"	\$189.95
TB145A-3	3/4", 1"	\$189.95
AP145	ATS Pro Beading Kit all sizes 1/4" to 1"	\$459.95

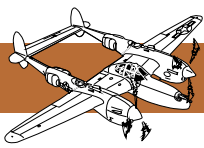

SERVICE & SUPPORT

IMPERIAL® TRIPLE HEAD BENDER



For making 45°, 90° and offset bends in tubing. Bends aluminum, copper, steel and other metal tubing.

- 367FH..... (Bends 1/8", 3/16" & 1/4")..... \$32.95
 368FH..... (Bends 3/16", 1/4", 5/16" & 3/8")..... \$39.95

ROL-AIR® 37° FLARING TOOL



The industry standard Rol-Air® is the choice of professionals. Flares soft copper, aluminum and brass tubing. The faceted hard chrome coated cone rolls out perfect 37° flares above the die block, and then automatically burinishes the flare face while maintaining the original

wall thickness at the base of flare. New slip-on yoke permits use in tight quarters. Satin chrome and black finish. Able to flare 3/16" 1/4" 5/16" 3/8" 1/2" and 5/8" O.D. tubing. *Not recommended for stainless steel.*

- 507FB..... \$95.95

LEVER TYPE TUBE BENDERS



Each tool only bends one size. Open side type which slips over the tube at any point. Makes smooth short radius bends up to 180° in aluminum, copper, and mild steel.

PART	TUBE DIA.	BEND RADIUS	WEIGHT (LBS)	PRICE
4-2829	1/4"	9/16"	1	\$52.95
5-2829	5/16"	11/16"	1	\$69.95
6-2829	3/8"	15/16"	2	\$59.95
8-2829	1/2"	1-1/2"	3	\$117.95
10-2829	5/8"	3"	6	\$153.95
12-2829	3/4"	3"	7	\$215.95

IMPERIAL® 37° HEAVY-DUTY FLARING TOOL



Flares 1/8" stainless steel primer lines!

Forms 37° flares in annealed stainless steel (MIL-T-6345 or AMS5566), cold drawn stainless steel, copper, aluminum, brass, and other soft metals. Ball thrust bearing mechanism reduces the effort required to produce perfect 37° flares, even in stainless steel. Made of hardened tool

steel, and features a non-slip grip which securely holds tubing, even after repetitive flaring. Extension on bar can be clamped in a vise for extra support. Able to flare 1/8" 3/16" 1/4" 5/16" 3/8" and 1/2" O.D. tubing.

- 447F..... \$373.95

ROL-AIR® 37° AVIATION FLARING TOOL



Flares T6845 aviation grade stainless steel

Forms 37° flares in aircraft grade stainless steel (MIL-T-6845), titanium, and other metal tubing, both soft and hard. Positive stop gauge assures correct size of flare. The three rollers in the flaring cone roll out 37° flares above the die block while burinishing the flare face to a smooth finish. A built in

extension on the yoke can be clamped in a vise for extra support. Satin chrome and black nickel finish. **Note: Use of the optional 401FA Reamer Yoke is recommended when flaring aviation grade stainless steel tubing.**

- 400F..... (3/16", 1/4", 5/16", 3/8", 1/2", & 5/8" Tubing) .. \$398.95
 401FA..... (Optional Reaming Yoke for Stainless Steel)..... \$69.95
 402FA..... (Kit Consisting of 400F & 401FA)..... \$415.95

IMPERIAL® ROTO-LOK™ TRIPLE HEAD 180° TUBE BENDER



This improvement on the old "Imp" 3-in-1 bender (368FH), features Imperial's patented Roto-Lok™ quick-action indexing lever. It's a two-stage handle that automatically repositions itself midway through bend to allow easy fabrication of bends up to 180° with reduced effort, better control and no crossing of handles

Up to 180 degree bends in sizes: 3/16", 1/4", 5/16", and 3/8" O.D. tubing.

- Bend radii are: 7/16", 9/16", 11/16", and 15/16" respectively.
 - Works with copper, aluminum, brass, thin wall steel, and thin wall stainless.
- 470FH..... (Bends 1/8", 3/16", 1/4", 5/16" & 3/8" O.D.)..... \$41.95
 370FH..... (Bends 1/4", 3/8" & 1/2" O.D.)..... \$51.95





TUBE BENDER



Special nylon forms prevents kinking or flattening. Easy to use with one end of the tube connected, or the unit can be mounted in a vice. For 3/16", 1/4", 5/16", and 3/8" O.D. tubing. Not recommended for 3/8" steel.

44000.....\$18.95

JUMBO ROD BENDER



BAC Industries Jumbo Rod Bender bends a variety of wires up to 3/8" diameter. Forms round, square and flat stock into hooks, 'S' loops, and other bends 3/16", 1/4", 3/8", 5/8", and 3/4" radius.

MR-01.....\$31.95

IMPERIAL® RATCHETING TUBE CUTTER

A mini-tube cutter mounted in a ratcheting handle to quickly cut through copper, aluminum, brass, steel, stainless steel, monel, titanium, and other tubing. Cuts from 1/8" to 7/8" O.D. tubing. Mini tube cutter can be removed from handle and used to cut tubing in tight areas (requires only 1-1/4" clearance).



TC1050RH.....\$23.95

INNER-OUTER REAMING AND DEBURRING TOOL



Reams both the inside and outside edges of 3/16" to 1-1/2" diameter tubes with the aid of three hollow ground cutters. Fluted body fits comfortably in the palm of your hands.

208F..... (Copper, Alum., & Soft Metals).....\$22.95

208SS..... (All metals).....\$62.95

PARKER 37° FLARING TOOL

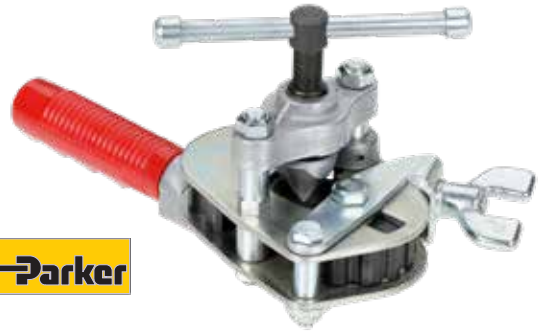

The Parker Hannifin flaring tool is designed to make perfect 37° flares in aluminum, copper, brass, and mild steel tubing. The hardened tri-fluted cone burnishes the tubing as it creates the flare without scoring the surface. A built-in stop positions the tube prior to flaring so that your flares are always perfect. Tube Sizes 1/8", 3/16", 1/4", 5/16", 3/8", 7/16", 1/2", 5/8", 3/4".

212FB.....\$109.95

IMPERIAL® 8 PIECE TUBE BENDER KIT



The patented spring coil design of these tube benders allows you to bend aluminum and copper tubing in to complex shapes without crushing or creasing the tube. Simply slip the belled end of the bender over the tubing and slide to the point to be bent. Complete kit contains eight (8) benders for tube sizes: 1/4", 5/16", 3/8", 7/16", 1/2", 5/8", 3/4", and 7/8" OD.

201-F.....\$27.95

TUBE CUTTERS



374FC



127FB

Heavy-duty cutter makes clean, right angle cuts with absolutely no burrs. Kit includes roller, spare cutting wheel and foldaway reamer. Cuts or constricts tubes from 1/4" to 1-5/8" (6-413mm). Hardened roller and cutter for long working life.

374FC..... (Deluxe Tube Cutter).....\$17.95

127FB..... (Mini Tube Cutter).....\$7.95

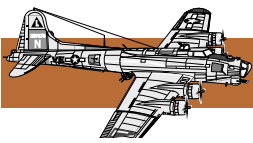

SERVICE & SUPPORT

INLINE AIR OILER



Automatically feeds your air tools with the proper amount of oil for longer tool life. 1/4" NPT thread.

5830.....\$11.95

SWIVEL CONNECTOR



2563



7922R

Eliminates twisted air hoses forever. This connector swivels 360° and keeps your air hose straight no matter how your tool is held. Screws into any 1/4" NPT air tool. I

2563.....\$13.95

7922R.....(W/ Regulator).....\$12.95

THREE IN ONE AIR LINE MANIFOLD



Supply three air tools from one source! Use on air hose end or as permanently fixed bench outlet. No need to disconnect/connect to use different tools. Three 1/4" NPT outlets and a single 1/4" NPT inlet makes this a useful shop accessory.

3404.....\$11.95

PROFESSIONAL AIR REGULATOR



1824



5401



1370

Fits any tool with 1/4" thread.

1824.....(Positive Locking).....\$14.95

5401.....(Regular).....\$7.95

1370.....(W/Gauge).....\$12.95

ULTRA FLEXIBLE 3/8 PREMIUM HYBRID HOSE



- Offers increased cold weather flexibility over - competitive hoses: -40 to + 150 degrees F.
- Made of a hybrid polymer, non-marring material
- 3/8" ID hose has 1/4" male NPT brass fittings
- Has 300 PSI pressure rating

Ultra Air takes hybrid to a new level, with increased cold weather flexibility over competitive hoses. When uncoiled, the hose lays flat making it easier to use with no interruption in air flow.

575-100A 100 FT \$39.95

575-50A 50 FT \$19.95

INDUSTRIAL AIR HOSE WITH FITTINGS



- Inside diameter: 3/8".
- Max pressure: 200 psi.
- Fittings: 3/8 npt.

PART	ID	MAX. PSI	FITTING	LG	PRICE
610	3/8"	200	1/4" NPT	25'	\$28.95
611	3/8"	200	1/4" NPT	50'	\$38.95

AIR HOSE COUPLERS



MC20F



MP20M

"Quick connect" style plugs and sockets will attach to any 1/4" air line. 1/4" pipe thread fittings.

MC20F (Female Socket) \$4.95

MP20M (Male Plug) \$2.05

SIDE WINDER AIR HOSE REEL



The Side Winder air hose reels allow you to coil and uncoil your air hose neatly and quickly to prevent damage. They have two built-in tool hangers to keep your air chuck, blow gun, or other air tools handy, and their constant supply 1/4 in. NPT brass swivel keeps air flowing freely and can handle up to 250 psi, even when dispensing or winding the air hose!

50350.....\$78.95





PHENOLIC SCRAPERS

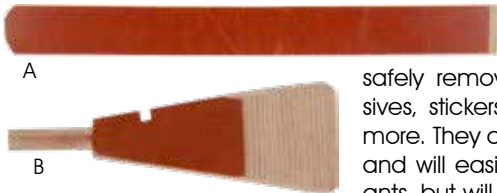

Phenolic scrapers are perfect for safely removing sealants, adhesives, stickers, labels, grime, and more. They are extremely durable and will easily slice through sealants, but will not damage the underlying structure.

PART	FIG	TYPE	SIZE	PRICE
PH01	a	Hand	3/4" x 8"	\$4.95
PH02	a	Hand	1" x 8"	\$4.95
PH03	a	Hand	1-1/2" x 8"	\$5.95
PH04	a	Hand	2" x 8"	\$7.95
PHRG01	b	Air Gun	2" x 9"	\$38.95
PHRG02	b	Air Gun	2" x 3-3/4"	\$29.95
PH-SET	Set of all 6 scrapers			\$61.95

SR CUTTER 5 PACK



The "SR" Sealant Cutters from 3M tackle the difficult job of removing aircraft sealants in a wide range of situations including aircraft wing fuel tanks. Because SR Cutters have a hollow core, they can remove sealant around the heads of aircraft fasteners such as rivets, Hi-Loks or bolts.

30095-5PK.....(#8 .83"X1.015").....\$29.95
 30096-5PK.....(#3 .40"X.975").....\$25.95

SR RADIAL BRISTLE DISC 10 PACK



When used at recommended operating speeds, our Scotch-Brite™ SR Radial Bristle Disc removes thin layers of sealants, silicones, RTVs and adhesives from most surfaces without removing the underlying paint or coating. Bristle products have no hard edges the way other wheel products do, so they can be compressed to fit into curves and hollows without inducing damaging gouges and trails on the work piece.

30097-10PK.....(#8 .83"X1.015").....\$50.95
 30098-10PK.....(#3 .40"X.975").....\$50.95

DUALCO™ COMPACT GREASE GUN



DL10350-SL3

Dualco is a leading provider of quality lubricating equipment, and their Compact Grease Gun is among their most popular product. Its durable cast aluminum construction is designed to last a lifetime, and has a precise delivery system to apply just the amount of grease you need. It's self-priming and accepts tubes with 9/16-18 threads. A wide variety of tips are available for any application. Made in the USA. 100% repairable and recyclable.

- Compact and easy to use
- Durable all metal construction
- Self activated priming
- Quick service, refill & cleaning
- Ground plunger & ball check
- Pinpoint accuracy

DL10350-SL3(Combo Kit).....\$14.95
 DL10350.....(Gun Only)\$9.95
 21030.....(3 oz Tube of Grease Only).....\$5.95

DUALCO™ GREASE GUN ACCESSORY TIPS

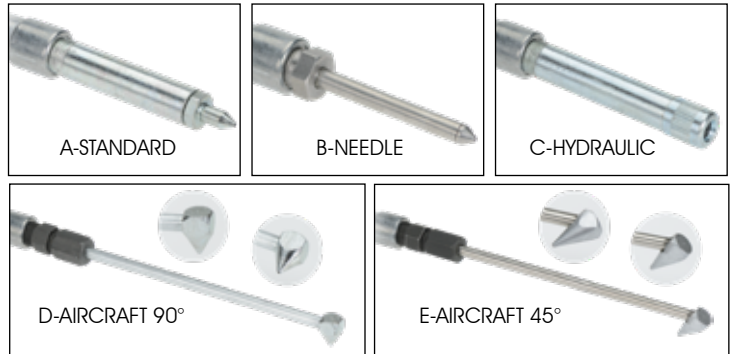

There's a Dualco tip for every greasing application. Our listing below features a selection of the more popular tips. Each tip features a 1/8" NPT male thread to fit into a Dualco, or any other standard grease gun.

PART NUMBER	STYLE	LENGTH	PRICE
DL10503	A	13/16"	\$3.95
DL10530	C	2-1/2"	\$10.95
DL10546	B	2-1/4"	\$12.95
DL10547	B	4-1/2"	\$13.95
DL10555	B	12"	\$19.95
DL10560	D	6"	\$24.95
DL10570	E	6"	\$26.95
DL10581	A	13/16"	\$3.95
DL10583	A	4-1/2"	\$11.95
DL10586	A	2-1/2"	\$10.95



SHOP EQUIPMENT

BRANSONIC MODEL 1800



Brasonic Ultrasonic Cleaners are faster, more consistent and safer than many other methods. They are powerful enough to remove grease, and heavy oils; yet completely safe for delicate items such as electronic components and fuel injectors.

TANK SIZE (LXWXD)	CAP. (QT)	OVERALL SIZE (LXWXH)	WGT. (LBS)
6" x 5.5" x 4"	2	10" x 12" x 11.5"	7

- B1800-MT (Mechanical Timer, Unheated)..... \$465.95
- B1800-MTH (Mechanical Timer & Heater) \$515.95
- B1800-DT (Digital Timer, Unheated) \$604.95
- B1800-DTH (Digital Timer & Heater)..... \$652.95

BRANSONIC TRAYS



The Brasonic trays hold parts to prevent them from touching the inside of the tank.

- B100-410-160 (Perforated Tray) \$109.95
- B100-410-170 (Solid Tray)..... \$95.95
- B100-916-333 (Mesh Tray) \$69.95

For more options visit our website www.aircraft-tool.com

BRANSONIC MODEL B200



The popular B200 is a compact and stylish unit intended for cleaning smaller, more delicate components such as injector nozzles. It includes a cover, and parts basket. 1 qt capacity 6.5" x 3.5" x 2.5" tank size.

- B200 \$169.95



BRANSONIC ULTRASONIC CLEANING SOLUTIONS

Pour on the cleaning power with Branson cleaning solutions! 32 oz bottle.

PART	DESCRIPTION	PRICE
BRANSON-JC	Jewelry cleaner for very delicate parts	\$13.95
BRANSON-IS	Industrial Strength maximum cleaning	\$15.95
BRANSON-MC3	Metal Cleaner safe for alum. & titanium	\$14.95

ELMASONIC CLEANER



EP10H



EP40H



Choose the easily operated Elmasonic E Plus for fast and thorough cleaning of a wide range of parts and instruments. Sweep frequency assures uniform cleaning action. The user activated Pulse mode adds bursts of 20% additional power to remove stubborn contaminants, to quickly degas fresh cleaning solutions or to prepare lab samples.

PART NO.	TANK SIZE (LXWXD)	DESCRIPTION	PRICE
EP10	7.5 x 3.3 x 2.4	0.25 Gal.	\$373.95
EP10H	7.5 x 3.3 x 2.4	0.25 Gal. w/ Heat	\$446.95
EP20H	5.9 x 5.4 x 3.9	0.50 Gal. w/ Heat	\$495.95
EP30H	9.4 x 5.4 x 3.9	0.75 Gal. w/ Heat	\$630.95
EP40H	9.4 x 5.4 x 5.9	1.00 Gal. w/ Heat	\$882.95
EP60H	11.8 x 5.9 x 5.9	1.50 Gal. w/ Heat	\$990.95
EP100H	11.8 x 9.4 x 5.9	2.50 Gal. w/ Heat	\$1,159.95
EP120H	11.8 x 9.4 x 7.9	3.50 Gal. w/ Heat	\$1,495.95
EP180H	12.9 x 11.8 x 7.9	5.00 Gal. w/ Heat	\$1,995.95
EP300H	19.9 x 11.8 x 7.9	7.50 Gal. w/ Heat	\$2,395.95

BASKETS



Baskets hold parts being cleaned because the parts should not come in contact with the cleaning tank itself. Baskets rest on supports so that they too do not come in direct contact with the tank bottom or walls.

PART NO.	TANK	PRICE
1004170	EP10	\$54.95
1004170	EP10H	\$54.95
1004209	EP20H	\$59.95
1004176	EP30H	\$68.95
1004232	EP40H	\$74.95
1004243	EP60H	\$99.95
1004178	EP100H	\$209.95
1004277	EP120H	\$209.95
1004275	EP180H	\$237.95
1004271	EP300H	\$273.95





PRIMER PISTOL™



Primer Pistol™ is the simple and cost effective way to apply small amounts of primer paint and liquid with minimal cleanup time. It's a very handy tool that uses disposable 35mm film canisters as the delivery jar so that you'll use that expensive primer in stingy amounts. It also makes cleanup a snap -- just throw away the jar and the pickup tube and you're done. A great toolbox item for touch-up work.

- SA-PP01(Primer Pistol).....\$15.95
- SA-PP01H...(Rep Tubes- 10pc)\$1.95
- 161932.....(Canisters).....\$0.60

PRECISION OILER

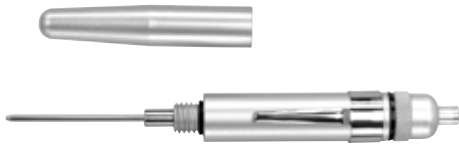

A Precision Oiler is a highly accurate lubrication tool intended for anyone working with small mechanical parts. The needlepoint tip allows for the precise placement of oil in confined areas. The smooth thumb actuator lets you control the release of lubricant from the reservoir in small droplets. The Precision Oiler includes a screw-on cover and pocket clip for use on the go.

- GT589(General).....\$10.95
- 15200T(Titan)\$11.95

GREASE JOINT REJUVENATOR



The Grease Joint Rejuvenator opens clogged grease joints and fittings effortlessly in less than a minute. Loosens dried grease in joints with just a tap. Also comes with a flexible shaft.

- 7862.....(Professional Model)\$49.95
- 7864.....(Pocket Model)\$29.95

ATS PRO MINI VACUUM



We've redesigned our popular Mini Vacuum Cleaner to provide even more quality and value for your money. The vacuum housing section is now manufactured from cast aluminum, and the valves are made from marine-grade brass.

- ATSMV01\$26.95

WONDER GUN AIR VACUUM



A two-in-one tool that's both an air operated vacuum cleaner, as well as a blow gun. Use it as a vacuum cleaner to pick up metal shavings, liquids, and small parts. As a blow gun, it can be used to clear debris from work areas, clean up machines, etc. 1 year warranty.

- WG01\$35.95

LED WORK LIGHT



WL300R



WL500



WL100

LED trouble drop lights are ideal for use in the hangar, workshop, or home, providing 750 lumens of hands-free lighting for workshop jobs and maintenance requiring close proximity illumination. The long-lasting LEDs are fully integrated (no more changing out delicate halogen bulbs) and produce much less heat than a halogen work light, making them a safer option for the job site.

These sturdy drop lights feature a durable metal Gorilla cage to protect the bulb, a built-in on/off switch, a 3-prong socket, and a hook at the top for convenient placement during automotive work or for lighting dim areas. Plus, the generous 25 ft. cord gives you the freedom to shine bright light anywhere it's needed.

- WL500(LED Battery Drop Light).....\$59.95
- WL300R(Corded LED Drop Light)\$41.95
- WL100(LED Drop Light Bulb).....\$17.95

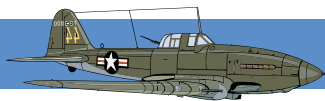

SHOP EQUIPMENT

MULTI-PORT AIR GUN



This innovative air gun acts as a handy air broom to sweep away debris from unwanted areas such as wing surfaces, cowlings, wheel skirts, cockpit areas, and anywhere else you need an extended reach. The multi-port design delivers air uniformly along the length of the wand, so that you can sweep away debris in one pass.

8050.....	(12").....	\$26.95
8051.....	(24").....	\$30.95
8052.....	(36").....	\$37.95
8053.....	(48").....	\$44.95

RIGHT ANGLE FUNNEL



10" Tall Translucent Funnel with a 6-3/4" Offset from Center of Mouth to Center of Spout for Hard-to-Reach Applications. The funnel mouth is 3.5" O.D. and the spout is .7" O.D.

17232.....	\$8.95
------------	--------

FLUID DRAIN PAN



This rectangular drain collector is designed to fit perfectly onto a standard IBC tote, or any other similar storage container (not included). The extra-wide 14" width will accommodate anything from small oil filters to large cans and pails. The length extends to the edge of the tote with little or no overhang, thus providing a maximum work area without the risk of accidentally knocking the funnel out of place. It comes with a catch screen to support small containers and filters as they drain, and the 3" diameter drain spout reduces the chance of clogging this funnel while draining thick or heavy liquids.

BFN1.....	\$89.95
-----------	---------

HEAVY DUTY PRODUCTION PAINT GUNS



Designed for day in and day out professional use. Non-bleeder, siphon feed with external mix. Operates on 40 to 85 psi at 5 to 12 CFM. Includes 1 quart cup.

36622.....	(Choice Tool).....	\$55.95
19418.....	(Titan).....	\$26.95

SPRAY WAND ENGINE CLEANER



Connect to any air source. Sprays solvents or any cleaning solution. Complete with siphon hose.

37CB.....	\$24.95
-----------	---------

BLOW GUN



Meets OSHA standards as to maximum PSI and noise level.

D420.....	\$6.95
-----------	--------

SPOT SPRAY NON-AEROSOL SPRAYER



These eco-friendly sprayers are refillable and eliminate dangerous, harmful propellants. 80-150 psi operating pressure. Refillable and not for use with paint products. Eliminates dangerous, harmful propellants. Maximum capacity 32 oz.

19419.....	(Red).....	\$26.95
19424.....	(Blue).....	\$26.95
19421.....	(Red & Blue).....	\$49.95



HEAT GUN W/ ACCESSORIES



General purpose heat gun deliver airflow and has 28mm diameter nozzle. Well balanced and lightweight body; temperature setting at 380 C. Double insulated with an impact resistant heating element make the heat gun ideal for industrial applications. Features: 28mm Diameter nozzle Temperature setting at 380 C 20 degree Celsius Advanced motor housing design with improved heat dissipation

SS-611A.....\$58.95

HEAT GUN



This is a high performance, hot air source that delivers concentrated, heated air to the job. Has two heat selections: 750°F and 1,000°F. Only weighs 1/2 pound. Operates on 120 volts, 10 amps, 1,200 watts. Contains no asbestos. UL listed. Three special nozzles available for easy attachments included in the accessory kit.

22400.....\$17.95

FURNO HEAT GUN



The Furno Dual Temperature Heat Gun is a versatile tool for dozens of applications. The broad temperature range makes it ideal for a variety of projects, it is ideal for forming and bending plastic, loosening rusted bolts.

0503059.....(750° F - 1100° F).....\$26.95
0503063.....(150° F - 1200° F).....\$41.95
0503070.....(125° F - 1300° F).....\$62.95

DUAL WALL HEAT SHRINK TUBE



45239



45238

Weatherproof heat shrink tubing offers waterproof protection and insulation on solder connections and components. This tubing features an adhesive-lined inner wall to seal out moisture.

45239.....(106 pc Kit 3:1 Shrink Ratio).....\$29.95

45238.....(171 pc Kit 2:1 Shrink Ratio).....\$15.95

4" HEAT SHRINK TUBES



- 1/16 in. 60 pieces
- 3/32 in. 35 pieces
- 1/8 in. 20 pieces
- 3/6 in. 10 pieces
- 1/4 in. 10 pieces
- 3/8 in. 10 pieces

Used for electrical insulation, bundling and wire identification purposes. Slides easily over small inline splices and connectors. Can shrink down to 50% of its original diameter to fit snugly over any wire, hose or cable. Ideal way to terminate ends of Braided Sleeves, creating a tight, professional finish.

E902-460.....(Colored).....\$13.95

E902-355.....(Black).....\$10.95

PROPANE HEAT GUN



This propane heat gun is perfect for use with wiring and paint removal projects. Its high temperature range makes it a great tool for thawing frozen pipes and bending plastics. The heat gun connects to disposable propane cylinders that are widely available. In addition to the heat gun itself, this offer includes a hands free vertical stand, a spreader nozzle and a deflector nozzle. This product does not include a propane cylinder.

51886.....\$75.95



SHOP EQUIPMENT

GRYPMAT



No more worrying about tools sliding out of reach, the GrypMat is made from high quality polymers, making it non-slip, non-marring, and anti-static. The surfaces we work on can be curved, angular, or slick, giving tools plenty of opportunity to get away. Sliding or falling tools create a hazard for both personnel and equipment. Using the GrypMat will reduce these hazards.

GRYP-T	All 3	\$129.95
GRYP-S	Small	\$29.95
GRYP-M	Medium	\$44.95
GRYP-L	Large	\$69.95

LOCKING AIR TOOL HOLDER



This locking air tool holders allow you to organize your valuable pneumatic tools and keep them from falling off by locking them up. The 10 in. wide, powdercoated steel racks have five slots that hold most popular quick-connect fittings.

49960.....	\$20.95
------------	---------

PLIERS AND WRENCH RACK



Cut the clutter in your toolbox with these handy wrench racks! Constructed from durable plastic, these racks feature two different slot sizes to accommodate up to 13 tools. Indentations on the front edge of the wrench racks hold your tools upright, making it easy to find the wrench or pliers you're looking for.

40460.....	Black	\$15.95
40490.....	Red	\$15.95

MUTI-POSITION MAGNETIC NUT CUP



Features a strong magnetic base that attaches securely to vehicles, tool Boxes, bins, hoists and any other ferrous metal objects. The magnet has a coating to protect work surfaces and is oil and fuel resistant. Angled cup design allows it to be positioned vertically, horizontally, or any angle in between.

67300.....	\$15.95
------------	---------

COLLAPSIBLE RUBBER MAGNETIC PARTS TRAY



Perfect for holding small parts, hardware and fasteners in place. Sticks to any ferrous metal surface. Rubber covered prevents scratching .

21266.....	\$6.95
------------	--------

11" MAGNETIC STRAINER



This anti-rust stainless steel strainer is perfect for washing dirty tools. It is also great for collecting small metal items such as bolts, nails, screws and fasteners. The rubber coated magnet prevents scuffing and scratching surfaces.

11180.....	\$13.95
------------	---------

MAGNETIC PARTS TRAY



21265



21263



21260T

Magnetic Parts Tray perfect for holding parts, hardware and fasteners in place. Sticks to any ferrous metal surface - even works upside-down.

21265.....	(5-3/8" x 9-3/8").....	\$6.95
21263.....	(6.5" x 14")	\$15.95
21260T.....	(Set of 3).....	\$11.95



MULTI-PURPOSE ORGANIZER



Individual compartments are perfect for storing small parts, hardware and other supplies. View your contents easily with the clear plastic, hinged lid..

- 21267..... 4 Compartments \$4.95
- 21268..... 9 Compartments \$8.95

MULTI-PURPOSE 12 DRAWER ORGANIZER



This organizer has the ability to mount to a wall or stand alone on a bench. It features 8 small drawers and 4 large drawers making it great for storing and organizing small parts, hardware and accessories.

- 21269..... \$15.95

MAGNETIC TOOL HOLDER



Magnetic tool holders are ideal for your home, shop, or garage. These magnetic tool holders are powerful enough to hold even heavy hand tools. It provides compact wall storage for your most frequently used tools.

- 21300..... (13") \$21.95
- 21400..... (24") \$31.95

MULTI-ANGLE SWIVEL VISE



This Multi-Angle Swivel Action Vise is light weight, durable, and features an aluminum die cast construction for durability. Designed to swivel 360 degrees and tilt 90 degrees, this vise will assist you at any angle. It come complete with a 2" metal jaw that opens fully to 2 1/2". The triangular base vacuum measures in at 6 1/4".

- E902-117.....(Vise) \$45.95
- E902-117J.....(Replacement Jaws) \$2.15

HOMAK® 22" CANTILEVER TOOLBOX



Manufactured from heavy duty 16 gauge steel, double-welded, coated with two layers of hard enamel for unbelievable durability. Great cantilever design gets maximum storage while making it easy to get to any tool you want. You'll like the way it opens to see all your tools at a glance. Moveable/Removable partitions and divider set permit you to create 6 compartments in two trays. 22-1/2" Width, 11" Depth, 12-5/8" Height, with 6 Trays .

- KMC-1022..... \$121.95

MILITARY "G.I." CANVAS TOOL BAG



This heavy duty canvas bag is perfect for toting tools around in the field. It contains ample space for a rivet gun, bucking bars, and plenty of pouch space for accessories. Opens easily with sturdy brass zipper.

- CB21-11 (11") \$16.95
- CB21-17 (17") \$24.95

HIP ROOF TOOLBOX



General purpose, sturdy co-polymer construction, large partitioned tote tray, large nickel-plated steel draw-bolts. Lockable padlock eye. 19"W x 9-1/4"H x 10"D.

- 19000..... \$25.95

TOOL BOX DRAWER LINER



These versatile rubber mesh liners keep your tools and other items from sliding around. They're durable, washable, and can be easily cut with scissors to fit your toolbox and/or drawers.

- 30931..... \$5.95

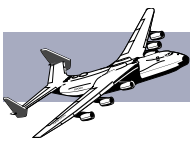

POWER TOOLS

ATS 3/8" MICRO AIR RATCHET



Mighty-mite air ratchet only 4-1/2" small, but delivers up to 20 ft-lb (27 Nm) of torque to handle even the most stubborn nut or screw. 3/8" driver features a built-in 1/4" hex receptacle so you can use it as a ratchet wrench, or as a screwdriver. Great dual-purpose tool. 260 rpm, Handle exhaust, 1/4" NPT air inlet, 90 psi max.

ATS3031.....\$85.95

ATS STUBBY RATCHET



Stubby air ratchet is only 6" long, but delivers enough torque to tighten or loosen the toughest bolts and nuts. Ergonomic design makes it very comfortable in the hand.

- 240 RPM Free Speed
 - 30 ft-lb (40 Nm) torque
 - 6-1/2" long
 - Front exhaust
- ATS3003..... (1/4" Drive)\$85.95**
ATS3004..... (3/8" Drive)\$85.95

ATS HIGH SPEED CUT-OFF TOOL



Perfect for cutting and trimming studs and bolts. Features a safety hood to protect against flying debris. 3" (75 mm) disc capacity, 3/8" (15 mm) mount. Free speed 20,000 RPM. Weight 1.74 lbs (.79 kg).

ATS8502.....\$49.95

ATS ADJUSTABLE CLUTCH AIR SCREWDRIVER



A powerful, direct drive screwdriver with a positive control clutch system that delivers high torque when you need it, but can be adjusted down to prevent stripping of even the smallest screw heads.

- Internal Adjustable Cushion Clutch
- 1/4" Hex Drive
- 8-1/2" (216 mm) Overall Length
- 800 RPM
- 45-115 in-lb (5-16 Nm) Torque
- 2.64 lbs (1.2 kg) Weight

ATS6203.....\$119.95

ATS STRAIGHT AIR SCREWDRIVER



Has all the same features as our ATS6203 Pistol Grip Screwdriver in a straight form that allows you to use it in tight areas that would otherwise be unreachable.

- Internal Adjustable Clutch
- 1/4" Hex Drive
- 10-3/8" (265 mm) OAL
- 1,800 RPM
- 45-115 in-lb (5-13 Nm) Torque
- 2.55 lbs (1.16 kg) Weight

ATS6212.....\$135.95

SWIVEL BIT HOLDER



1/4" hex shank. 30 degree swiveling head. Locks into stationary position as desired.

16227.....\$9.95

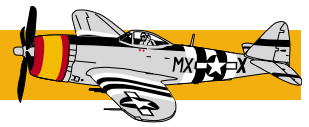

SCREW-GRAB®

Just a drop of Screw Grab® placed onto the head of a stripped screw or rounded bolt will increase the torque by up to 400% and allow you to easily tighten or remove them. The special emulsion will not stain or react chemically.

SG94 \$6.95

ALDEN GRABIT-PRO® BROKEN BOLT AND DAMAGED SCREW REMOVER



Works on damaged screws and broken bolts from as small as 4 screw to as large as a 3/8" bolt. It easily removes most damaged screw types such as Hex, Phillips, Torx, and Square Drive from wood, plastic or metal up to 3 inches in length. Two-step drill bit and extractor in one tool extracts broken bolts and damaged screws fast; use in reverse only when drilling and extracting with reversible hand held power drill.

PART	QTY	REMOVES SIZES			PRICE
		AN SCREW	AN/SAE BOLT	METRIC BOLT	
8401P	1 ea.	4 - 7	10	M5	\$9.95
8402P	1 ea.	6 - 10	1/4"	M6	\$9.95
8403P	1 ea.	12 - 14	5/16"	M8	\$9.95
8404P	1 ea.	16 - 24	3/8"	M10	\$10.95
8440P	4pc Kit	4 - 24	10 - 3/8"	M5 - M10	\$26.95
8430P	3pc Kit	4 - 14	10 - 5/16"	M5 - M8	\$19.95
8420P	2pc Kit	4 - 10	10 - 1/4"	M5 - M6	\$15.95

ALDEN DRILL-OUT® BROKEN BOLT EXTRACTOR



Drill-out is a drill-bit and extractor in one tool. It drills into broken bolts on center and extracts them cleanly using the power of the drill. Simply chuck the self-centering bit, set your drill to reverse, and drill at medium speed to extract the bolt. Drills up to grade 8 and 10.9 class fasteners with no pilot hole required. Made from M2 HSS in the USA.

PART	QTY	REMOVES SIZES		PRICE
		AN/SAE BOLT	METRIC BOLT	
4017P	4pc Kit	1/4" - 1/2"	M6 - M12	\$48.95
7017P	7pc Kit	5 - 1/2"	M3 - M12	\$60.95

SCREW AND BOLT REMOVER



"A very high quality must have tool. Paid for itself the first time I used it on a stuck screw. Wish I would have bought one 30 years ago." ~ G.W

Fits all rivet guns with a .401 shank and is held with a retaining spring. 3/8" square drive end. Used to remove screws, bolts, nuts, etc. that are corroded or cannot be loosened by conventional methods.

AT540A (10" Standard) \$20.95
 AT540B (6" Stubby) \$21.95
 AT54K (Adapter Kit) \$11.95

SMALL FASTENER REMOVER



For use with a Pneumatic Impact Tool to Loosen Rusted or Seized Fasteners. A 3/4" open end wrench can be used to turn the socket while impacting the fastener. A locking pin in the driver keeps the bit holder in place on the square drive for safe operation.

60530 \$29.95

SCREW EXTRACTOR SET



Five piece extractor set designed to remove broken screws and bolts. Easy to use, just drill a pilot hole, insert the extractor and twist out the screw. Set includes sizes: 1 for sizes 3/32" - 5/32", 2 for sizes 5/32" - 7/32", 3 for sizes 7/32" - 9/32", 4 for sizes 9/32" - 3/8", 5 for sizes 3/8" - 5/8".

S35P \$11.95

STUCK BOLT, NUT, AND STUD REMOVER SET



The 6 piece set removes standard and metric bolts, nuts and studs from 1/4" to 9/16" (6mm to 14mm).

Drive the proper size remover over the bolt head, nut or stud. The remover spline cuts into the bolt head or threads for a sure grip.

19250 \$38.95



HAND TOOLS



GEARWRENCH® AVIATION TOOLKIT

GearWrench specifically designed this kit with the A&P student in mind. It's part of their Technical Education Program (TEP) series aimed at making top quality GearWrench tools affordable for students. The kit contains the basic hand tools required by most curriculums and is, in fact, the recommended kit of many A&P schools across the country. All tools are of the highest quality, and backed by the GearWrench Lifetime Warranty.



1/4" DRIVE TOOLS	3/8" DRIVE TOOLS	SCREWDRIVERS & PLIERS
10 piece 12-point Set 3/16, 7/32, 1/4, 9/32, 5/16, 11/32, 3/8, 7/16, 1/2, 9/16 10 piece 12-point deep Set 3/16, 7/32, 1/4, 9/32, 5/16, 11/32, 3/8, 7/16, 1/2, 9/16 1/4" Drivers Full Polish Teardrop Ratchet, 3" extension, 6" Extension, Universal Joint	13 piece 12-pt set 1/4, 5/16, 3/8, 7/16, 1/2, 9/16, 5/8, 11/16, 3/4, 13/16, 7/8, 15/16, 1" 11 piece 12-pt deep set 1/4, 5/16, 3/8, 7/16, 1/2, 9/16, 5/8, 11/16, 3/4, 13/16, 7/8 3/8" Drivers Full Polish Teardrop Ratchet, 6" Extension, Speed Handle, Universal Joint	6 Pc. Screwdriver Set 1/8x3" Slotted, 1/4 x 4" Slotted, 5/16" x 6 Slotted, 3/8" x 8" Slotted, 1 x 3" Phillips, 2 x 4" Phillips 4 Pc Mixed Pliers Set 9.5" Tongue & Groove, 7" Diagonal Cutters, 8" Long Nose, 8" Slip Joint
COMBINATION WRENCHES	GENERAL PURPOSE TOOLS	SPECIALTY TOOLS
15 pc Long Combination Set 1/4, 9/32, 5/16, 11/32, 3/8, 7/16, 1/2, 9/16, 5/8, 11/16, 3/4, 13/16, 7/8, 15/16, 1"	Safety Goggles, Hearing Protection	23" Pickup Tool, Telescoping Mirror, Telescoping Magnet, Screw Starters, 1-1/4" Putty Knife, Scribe, Crimper, Tool Box

83080..... (Complete Kit)..... \$772.95

GEARWRENCH® OPEN END RATCHETING WRENCH

Ratcheting head



The open end actually ratchets! No need to reposition with every stroke, both box end and open end are ratcheting. 7 piece set in sizes: 5/16, 3/8, 7/16, 1/2, 9/16, 5/8, 11/16, and 3/4.

85599.....\$90.95

CROWSFOOT WRENCH SET



A set of 3/8" drive wrenches commonly used with torque wrenches. Sizes: 3/8", 7/16", 1/2", 9/16", 5/8", 11/16", 3/4", 13/16" and 7/8". Drop forged. Full polish, high chrome finish.

81908.....\$79.95

SAE X-BEAM FLEX HEAD COMBINATION RATCHETING WRENCH SET



GearWrench 9-Piece XL X-beam flex ratcheting wrench set consists of one each: 5/16", 11/32", 3/8", 7/16", 1/2", 9/16", 5/8", 11/16", and a 3/4" wrenches. Ratcheting box end needs as little as 5 degrees to move a fastener vs 30 degrees for standard box end wrenches. Surface drive design reduces fastener rounding. Flexible head on box end of wrench provides for multiple angles for better clearances in tight spaces. Open end of wrench features gear wrench surface drive, which reduces founding of fasteners and delivers 25 Percent more torque. Long pattern X-beam design provides for greatly increased torque and reduced hand fatigue. High polish nickel chrome finish and blow molded tray for storage.

85298.....\$186.95

85398..... (Reversible).....\$174.95





RATCHETING BREAKER BAR



This heavy duty breaker bar has a 3-way ratchet mechanism, chrome plated bar, black-oxide head, chrome vanadium steel construction, and a maximum torque of 148 ft/lbs (20 kg/m).

12015.....	(3/8" Drive x 15" Long)	\$29.95
12018.....	(1/2" Drive x 18" Long)	\$32.95
12019T.....	(3/8" Drive x 18" Long)	\$19.95
12024.....	(1/2" Drive x 24" Long)	\$36.95
12047.....	(1/2" Drive x 30" Long)	\$27.95
12048.....	(3/4" Drive x 40" Long)	\$72.95
12049.....	(1" Drive x 40" Long)	\$82.95

CRESCENT® "FORD" WRENCH



The original Crescent Wrench (aka Monkey Wrench, Ford Wrench, Spud Wrench). Tool of choice for removing and installing "B" nuts. Smooth jaws.

C79H.....	(9")	\$34.95
C711H.....	(11")	\$40.95
C715.....	(15")	\$69.95
C718.....	(18")	\$90.95

GEARWRENCH® STUBBY FLEX COMBO RATCHET SET



Small enough to fit in the palm of your hand, but provides enough leverage to tighten or loosen even the most stubborn nut. Features a ratcheting box end with a flex head to ensure access with tight areas. 7 piece set in sizes: 3/8, 7/16, 1/2, 9/16, 5/8, 11/16, and 3/4.

9570.....	(Flex Head)	\$142.95
9507.....	(Straight)	\$90.95

14 PIECE COMBINATION NON-RATCHETING WRENCH SET SAE



Includes sizes:

- 1/4"
- 5/16"
- 11/32"
- 3/8"
- 7/16"
- 1/2"
- 9/16"
- 5/8"
- 11/16"
- 3/4"
- 13/16"
- 7/8"
- 15/16"
- 1"

GearWrench's 81924 14-Piece SAE Full Polish Combination Non-Ratcheting Wrench Set offers wide ranging versatility in one convenient package. The wrenches feature full-polish nickel chrome plating construction for corrosion-resistant, long-lasting wear. Surface Drive Plus technology on open end provides a stronger grip, reduces fastener rounding, and offers increased torque. The offset box end for increased accessibility in hard-to-reach areas.

81924.....	\$99.95
------------	-------	---------

GEARWRENCH® ROTO RATCHET SET



The ratchet head rotates and operates a full 180° to work in confined areas. 72 teeth ratchet requires less than 5° to actuate. Set of 1/4" and 3/8" drives.

81223.....	(Set of 1/4" and 3/8" Drivers).....	\$73.95
------------	-------------------------------------	---------

ROUND SWIVEL-HEAD RATCHETS



Unique swivel head design for confined areas. 72 tooth ratchet mechanism. Chrome moly steel construction.

11066.....	(1/4" Drive 5-1/2")	\$16.95
11067.....	(3/8" Drive 5-3/4")	\$17.95
11076.....	(3/8" Drive 8-3/4")	\$23.95



HAND TOOLS

PRECISION DIAL TORQUE WRENCHES



Sturdy body construction ensures maximum durability with easy to read laser marked single scale. Large, easy to read dial is shock resistant and protected by a tough metal guard. The memory needle retains highest torque reading applied. Calibrated in both CW and CCW directions, with accuracy +/- 2%, from 2-100% of full scale. Individually serialized with matching certificate of calibration traceable to N.I.S.T.

PART	RANGE	DRIVE	GRAD	PRICE
KL45-751	0-75 in-lb	1/4"	1 in-lb	\$268.95
KL45-3002	0-300 In-Lb	3/8"	5 in-lb	\$262.95
KL45-502	0-50 ft-lb	3/8"	1 ft-lb	\$256.95
KL45-1003	0-100 ft-lb	1/2"	2 ft-lb	\$310.95
KL45-2503	0-250 ft-lb	1/2"	5 ft-lb	\$310.95

GEARWRENCH® ELECTRONIC TORQUE WRENCH



Digital precision guarantees exact torque settings by beeping when the desired torque (or angle) is reached. Accurate to +/- 2% CW and 3% CCW from 20% to Full Scale. Also measures angular torque to an accuracy of +/- 1%. Thin profile head features backlit LCD display that can be clearly read, even in poor lighting.

PART	RANGE	DRIVE	HEAD	PRICE
85070	10-100 ft-Lbs	3/8"	Straight	\$300.95
85071	25-250 ft-lb	1/2"	Straight	\$332.95

MICROMETER TORQUE WRENCH



Precision torque wrenches are accurate to within +/- 2%. The drive head is a sealed teardrop design that provide ease of access, strength, and keeps out contaminants. The drive reverses direction at the flick of a level, and the micrometer twist lock securely holds your torque settings even under heavy use.

PART	RANGE	GRAD	DRIVE	PRICE
85060	30-200 in-Lbs	1 in-lb	1/4"	\$145.95
85061	30-250 in-lb	1 in-lb	3/8"	\$129.95

PRECISION TORQUE SCREWDRIVERS



Positive locking pull down adjustment knob with automatic lock in counterclockwise direction. 1/4" hex bit holder with a cam-over torque limiting clutch. The easy to read window scale is accurate to +/- 6% clockwise direction and from 20-100% of full scale.

PART	RANGE	GRAD	PRICE
KL45-61SM	20-100 in-oz	1 in-oz	\$272.95
KL45-151SM	3-15 in-Lbs	.2 in-lbs	\$248.95
KL45-401SM	5-40 In-lbs	.5 in-lbs	\$309.95

REVERSIBLE TORQUE WRENCH



This torque wrench features a reversible head design that allows you to accurately torque both left and right hand fasteners. This wrench has an easy-to-read analog scale window for setting torque values in ft-lbs and Newton-meters. With a fully heat-treated handle this is one tough and durable wrench and it meets ANSI specifications.

23150	(1/2" 20-150 ft lbs)	\$79.95
23151	(1/2" 50-250 ft lbs)	\$90.95



3" MINI RATCHET AND BIT HOLDER



A two-in-one ratchet featuring one side that holds hex bits is a perfect addition to your toolbox. The compact handle is ideal for confined areas. Chrome vanadium steel finish.

12101.....	(1/4").....	\$11.95
12102.....	(3/8").....	\$12.95
12103.....	(1/2").....	\$13.95

DRIVE PIN PUNCHES



A set of hardened pin punches uniformly heat treated and centerless ground. Each set contains one each of the following diameters: 1/16", 3/32", 1/8", 5/32", 3/16", 7/32", 1/4", and 5/16".

SPC75.....	(Standard 4" 8pc Set)	\$31.95
SPC76.....	(Extra Long 8" 5pc Set)	\$27.95

COMBINATION DUAL-HEAD OFFSET RATCHETS



This 72 tooth ratchet mechanism engages with just 5 degrees of sweep for work in the tightest places. Contoured cushion with a grip handle for comfort and strength.

12052.....	(1/4 & 3/8")	\$14.95
12053.....	(3/8 & 1/2")	\$16.95
12357.....	(1/4" & 3/8" Flex Head)	\$15.95
12358.....	(3/8" & 1/2" Flex Head)	\$17.95
11050.....	(1/4" & 3/8" Stubby Flex Head)	\$13.95
12051.....	(3/8" & 1/2" Stubby Flex Head)	\$18.95

BRASS HAMMERS



Non-sparking brass hammers are ideal for working in volatile spaces.

B2.....	(1 lb)	\$34.95
B4.....	(2 lbs)	\$49.95

DEAD BLOW HAMMERS



Soft-faced dead blow hammers deliver a solid blow without recoil or excessive shock. Great for hard pounding.

CH1.....	(1-1/2")	\$19.95
CH3.....	(2")	\$26.95
CH5.....	(2-1/2")	\$36.95

FINGER RATCHETS



Buy them individually or in a set, these finger ratchets have a contoured grip for comfort and power during every job. They offer a reversible ratchet mechanism. Designed specifically to reach confined spaces.

12090.....	(1/4").....	\$6.95
12091.....	(3/8").....	\$7.95
12092.....	(1/2").....	\$7.95

ADJUSTABLE VISE GRIP WRENCH



IRWIN® VISE-GRIP® Adjustable Wrench provides the leverage you need for powerful tightening and loosening applications. Its Pro-Touch™ handle cushions your hand for fatigue-free operation.

2078606.....	(6")	\$13.95
2078608.....	(8")	\$15.95



HAND TOOLS

QUAD RATIO DRIVER (4:1 RATIO)



If you spend a lot of time installing and removing screws then the Ratio Driver will speed up your work by a factor of four. The geared drive mechanism ratchets the nosepiece 4 times for each turn of the handle; and the ratchet direction can be reversed with a quick flick of a switch. It accepts any 1/4" drive bits and includes an assortment of 8 bits in the handle compartment. The included bits are: Hex 3/32", 1/8", 5/32", 3/16"; Torx 15, 20, 25, 30; Phillips 0, 1, 2, 3; Slot 1/4", 3/16"; Roberts (square) 2, 3. Lifetime warranty.

SAB710.....\$29.95

18" 12PC RATCHETING SCREWDRIVER



18in. ratcheting driver with 10 bit choices and 250 in.-lbs. of torque gives you fastening capabilities like no other handheld driver. This screwdriver is extremely useful especially in hard-to-reach areas.

12218.....\$19.95

JEWELER'S SCREWDRIVER



Nickel plated body with screw chuck. Kit contains three size flat blades, one Phillips blade and one scratch awl. Comes in a fitted vinyl case.

SPC606.....\$6.95

10PC MICRO FLEX BIT DRIVER



At only 3-1/2" long this little ratcheting bit driver is the perfect tool for those tight spaces where a drill or screwdriver just won't fit. The Micro Bit Driver accepts any standard 1/4" hex-drive bit, and includes 8 driver bits of its own. The ratcheting mechanism is extremely fine so it can be used even in confined spaces where the handle arc is very short. Offset handle also aids access to obstructed spaces.

11212.....\$18.95

PRECISION SCREWDRIVER SET



A set of quality precision screwdrivers perfect for working on radios, electrical circuits, and other delicate instruments. They have a patented, ergonomic handle for greater comfort, and a swivel head offers rapid rotation. The set includes each of the following screwdrivers: 00-CP, 0-CP, 1-CP, 3/32"-Flat, and 1/8"-Flat.

700.....\$16.95

BIT SET



16251



16148

These master bit sets should cover it all! Set includes: Phillips, Metric and SAE Hex, Star and Slotted bits Includes convenient storage case.

16251.....(50 Piece Impact Bit Set).....\$58.95

16148.....(148 Piece Security Set).....\$45.95

RATCHETING PRECISION SCREWDRIVER



With its ergonomic handle and smooth ratcheting action, you'll find yourself reaching for this precision screwdriver set again and again. It's ideal for precision tasks where there is a risk of stripping or breakage, such as with brass fasteners, soft woods or electronic applications. The set includes a 4-1/2" extension bar for reaching into tight spaces, and two dozen 1" driver bits: (7) Phillips, (5) Slotted, (5) SAE Hex, (5) Star and (2) Tri-wing.

16092.....\$9.95





SPEED HANDLE



Fully polished Chrome Vanadium steel.

- 10-935 (1/4" Drive) \$35.95
- 11-935 (3/8" Drive) \$39.95
- 12-935 (1/2" Drive) \$49.95

THREADED HEX BIT ADAPTER

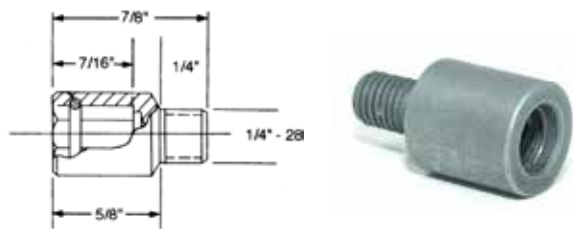

The Nova Threaded Bit Adapter lets you use your hex shank insert bits with any 1/4-28 threaded tool. Perfect for close quarters applications.

- PA28-450..... \$3.95

SCREW STARTERS



For starting screws in inaccessible areas.

PART	DESCRIPTION	PRICE
8082	Slotted screw starter 3/64" - 7/6" screws	\$9.95
8083	Phillips screw starter 6 - 1/4" screws	\$8.95

CABLE TIE FASTENING TOOL



Military style cable tie gun is made of solid metal for durability and features precise tensioning and controls. Can be used with a wide variety of cable ties and features an automatic cut off to flush cut the ties when the correct tension is achieved.

- CP-383 (Metal)..... \$69.95
- E900-005..... (Economy Tie Gun)..... \$29.95
- ELB721..... (Mini Tie Gun) \$7.95
- NT1 (Cable Tie 3/4" Max. Diameter, 4-1/2" Long) \$7.95
- NT2..... (Cable Tie 2" Max. Diameter, 7-1/2" Long)..... \$7.95

APEX BIT HOLDERS

Heavy duty drop forged bit holders will not break under heavy driving force. Works with all types of Flat, Phillips, Tri-Wing, and Torq insert bits.



- 93813..... (1/4" Hex Holder x 3/8" Drive) \$6.95
- 93815..... (5/16" Hex Holder x 3/8" Drive) \$6.95
- 93817..... (5/16" Hex Holder x 1/2" Drive) \$6.95

PHILLIPS® AVIATION APEX BITS

Genuine Phillips Tri-Wing® and Torq-Set® bits are drop forged for optimum toughness and resistance to wear. Each bit is 1" long and has a 1/4" hex shank.



TRI-WING

TORQ-SET

POINT SIZE	TRI-WING®		TORQ-SET®	
	PART	PRICE	PART	PRICE
0	-	-	TQ0	\$1.95
1	TW1	\$3.95	TQ1	\$1.95
2	TW2	\$3.95	TQ2	\$1.95
3	TW3	\$3.95	TQ3	\$1.95
4	TW4	\$3.95	TQ4	\$1.95
5	TW5	\$3.95	TQ5	\$1.95
6	TW6	\$3.95	TQ6	\$1.95
7	TW7	\$3.95	-	-
8	-	-	TQ8	\$1.95
10	-	-	TQ10	\$1.95

TORQ-SET HEX POWER BIT



TORQ-SET

Common fastener type in aviation and electronics industry.

PART	DESC	OAL	PRICE
TH0	#0	1-1/4"	\$1.95
TH1	#1	1-1/4"	\$1.95
TH2	#2	1-1/4"	\$1.95
TH3	#3	1-1/4"	\$1.95
TH4	#4	1-1/4"	\$1.95
TH5	#5	1-1/4"	\$1.95
TH6	#6	1-1/4"	\$1.95
TH8	#8	1-1/4"	\$1.95
TH10	#10	1-1/4"	\$1.95



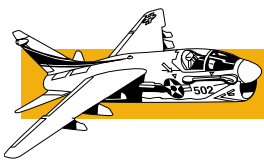

HAND TOOLS

PRECISION TAP AND DIE SETS



24606

24614

Precision machined to exacting standards, then Tempered-Tuff to assure clean accurate threading. 24 piece set handles 1/4" to 1/2" sizes. 41 piece set handles 1/4" to 1/2" along with 4 through 12 machine screw sizes.

PART	PCS.	RANGE	PRICE
24614	24	1/4" to 1/2"	\$104.95
24606	41	1/4" to 1/2", plus 4 to 12	\$142.95

TAP WRENCH KIT



T-Handle Tap Wrenches are designed for use with taps and many other tools turned by hand. Adjust and tighten to size by twisting knurled nut. Additional holding jaws are recessed inside the hole for gripping onto smaller sized taps. T-handles can be extended to either direction for more leverage.

- 12000-KIT (#0-1/2" 2 wrenches)..... **\$13.95**
- 12001 (#0-1/4") **\$5.95**
- 12002 (#1/4"-1/2") **\$7.95**

EXTEND-A-LUBE™



Finally, an aerosol focusing tube long enough to access those hard-to-reach places and the right product to keep you from losing it! The 16" chemical resistant tube is compatible with virtually all aerosol nozzles and ensures you will never drop your straw again!

- EXAL-1 **\$6.95**

TAP AND DRILL SET



These drill and tap combinations produce a thread that is strong and easy to tap 135° split point HSS drill bits ensure fast, precise drilling High carbon steel plug taps are ideal for general purpose threading Lock & Hardware Drill & Tap.

Plug Taps in sizes (4 - 40 NC, 6 - 32 NC, 8 - 32 NC, 10 - 24 NC, 10 - 32 NF, 1/4" - 20 NC)

Drill Bits in sizes (No. 43, No. 35, No. 29, No. 25, No. 21, No. 7)

- 80187** **\$29.95**

THREAD REPAIR FILE SETS



Thread repair files help breathe life back into bolts, screws or fittings that have been damaged due to cross-threading or corrosion. They restore damaged external threads on studs, bolts, screws, etc. Made of high carbon steel, the Repair Files offer eight different thread pitches. In addition, the Thread Repair Files can also be used as a screw pitch gage.

- GT177-1 (Threads 11,12,13,14,16,18,20,24 TPI)..... **\$10.95**
- GT177-2 (Threads 9,10,12,16,20,27,28,32 TPI)..... **\$10.95**
- GT177-8 ..(Threads 0.75,1.0,1.25,1.5,1.75,2.0,2.5 mm)..... **\$10.95**

FLEXIBLE EXTENSION BIT HOLDER



Flexible Extension Bit Holder with locking, magnetic, and quick release. Designed to flex and hold at various angle. 12x stronger magnet than standard bit holder. For use with hand or power tool driver.

- 16004 **\$19.95**





COTTER PIN PULLER



The Cotter Pin Puller helps you to easily and safely remove steel cotter pins from confined areas. The compound bend design facilitates use of the tool with either a pull or a twist motion. In addition, the heavy duty screwdriver handle provides a familiar, comfortable grip.

- GT64(General)..... \$8.95
- 15093..... (Titan) \$8.95

WASHER WRENCH SET

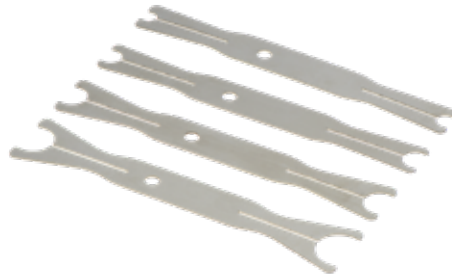

Slip washers in place with ease. Precision cut from 301 full hard stainless steel .042" thick. Fits most commonly used aircraft size washers.

- AE23800..... \$41.95

COTTER PIN ASSORTMENT 555PC



This 555-piece cotter pin assortment kits are quality replacements for rusted, damaged, or missing cotter pins. Kit contains a wide selection of pin sizes to suit numerous applications and is quite handy for the shop, home, or toolbox. These unique fasteners come in a resealable plastic case for quick and easy selection.

- 45205..... \$6.95

FASTENER HOLDER



This tool lightly grips fasteners for easier insertion into tight or blind spots. No more dropped or lost parts.

- AE5015..... \$9.95

SEAL AND O-RING REMOVER SET



These rounded tips allows for easy removal of seals and o-rings without damaging the seal or the finished surface. Set includes (2) Contoured Tips and (2) Spoon Tips. Lengths are 5-1/2" and 8-1/2"

- 17004..... \$13.95

BOLT GRIP



This tool lightly grips the heads of bolts and screws for easier insertion into tight or blind spots. No more dropped or lost parts. Double ended -- one end for -3 (3/16") fastener and one end for -4 (1/4") fastener. Bolt Grips are made from flexible stainless steel with an Overall Length of 12".

- AE5866..... \$23.95

407 PIECE SAE O-RING SET



The 407-piece O-ring assortment is a comprehensive SAE sized set of nitrile butadiene rubber (NBR) rubber o-rings, perfect for personal use, or in professional workshops and garages.

- NK407 \$16.95

HANDEE CLAMP



The Handee Clamp will securely hold onto whatever you put in its jaws, enabling you to reach into that tight crevice so you can focus on the job at hand and not worry about dropping the hardware you need. It also works great with those pesky Adel clamps that can be difficult to hold down while securing the bolt.

- HANDECLAMP-1 \$19.95

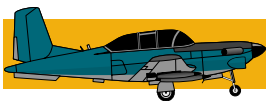

HAND TOOLS

PLIERS

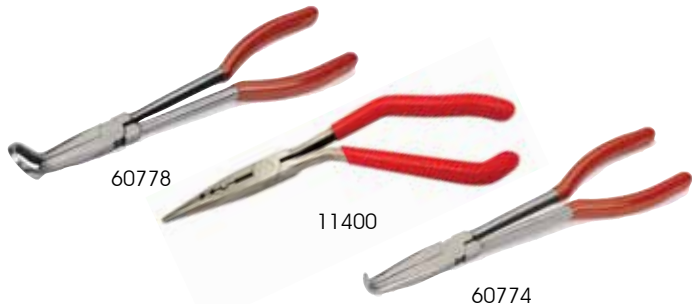

Constructed from durable, long lasting, drop forged heat treated high carbon alloy steel. Cushion grip handle for comfort. Easy to use.

PART	DESCRIPTION	PRICE
60778	Hose Grip Pliers	\$9.95
11400	Pistol Grip Nose/Crimper Pliers	\$9.95
60774	Long Nose 90° Pliers	\$8.95

DOUBLE X PLIERS



Designed with a compound joint that allows access with minimal handle movement. Includes dual dipped grips for comfort and aligned serrated tips for precision gripping.

- 82106..... (2 Piece Set - Straight and Needle Nose) \$64.95
- 82005..... (Straight Needle Nose) \$34.95
- 82006..... (45° Needle Nose)..... \$34.95
- 82107..... (3 Piece Hose Grip Plier Set) \$95.95

TITANIUM HAND TOOLS

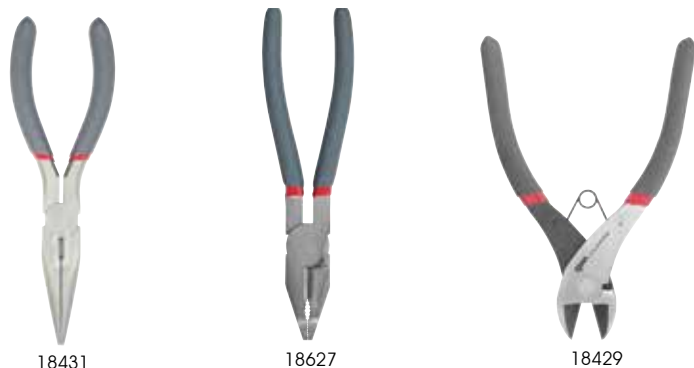

PART	DESCRIPTION	PRICE
18431	8" Titanium Bonded Needle Nose Pliers	\$19.95
18627	8.25" Titanium Bonded Linesman Pliers	\$26.95
18429	7" Titanium Bonded Side Cut Wire Cutter	\$25.95

VAMPLIERS SCREW REMOVING PLIERS



The amazing new Vampliers doubles as a regular pair of pliers, as well as a handy and effective screw remover. It uses a patented vertical and horizontal serration pattern to clamp onto screws (even if they are completely stripped) and remove them. Of course, it can also be used as a regular pair of pliers which features built-in wire cutters and wire strippers.

- VT001-KIT..... (Complete Kit)..... \$129.95
- VT001 (Standard) \$34.95
- VT001-5 (Mini) \$29.95
- VT001-8 (Pro 8")..... \$49.95
- VT001-7SJ..... (7" Slip Joint) \$36.95
- VT001-PCH (Tool Pouch)..... \$9.95

DOUBLE X SNAP RING PLIERS SET



Provides removal and installation of hard to reach snap rings where side to side access is restricted. Inter-changeable tips sizes include .038 to .070 straight and 45 degree.

- 82110..... \$69.95

SNAP RING PLIER SET

This cleverly designed combination snap ring pliers works to install and remove both internal and external snap rings.



- E100-022..... (Universal) \$14.95
- 46000..... (Inside/Outside)..... \$14.95
- 18400..... (Convertible) \$26.95



NICHOLSON® DUAL “VIXEN” FILE



Fast cutting “curved tooth” file cuts through aluminum, brass, steel, plastics, fiberglass, and composites without loading up. Features a coarse cutting surface on one side (10 TPI) for quick removal and a smooth cut on the other side (16 TPI) for finishing.

20547N (12”) \$41.95

NICHOLSON® MAGICUT™ PLASTIC FILES



Magicut files feature a pattern of narrow chip breakers created by steep and angled serrations for rapid removal of material with virtually no loading, even when working with soft plastics. Perfect for fiberglass, lexan, plexiglass, composites, and soft metals.

PART	DESCRIPTION	PRICE
07894	8” Flat	\$10.95
07917	10” Flat	\$12.95
07941	12” Flat	\$16.95

NICHOLSON® ALUMINUM FILES



Special double-cut teeth is designed specifically to quickly remove aluminum without clogging. Can also be used for smoothing.

PART	DESCRIPTION	PRICE
00024	8” Flat	\$12.95
00047	10” Flat	\$14.95
00070	12” Flat	\$20.95

More products available online

NICHOLSON® FILE HANDLES



21528N



21474H

Designed to fit most popular files. Tapered to enhance push force.

21474H (Ergonomic) \$4.95
21528N (Wooden) \$3.95

FILE CARD

Used to clean and remove buildup from files.



21455 \$8.95

SWISS PATTERN NEEDLE FILE SET



Our Swiss Pattern Needle File Sets have been designed to meet the needs of hobbyists, craftsmen, tool makers and jewelers. Every file is made from alloy steel and machined into distinctive shapes for various small scale and finishing applications. 12 piece set.

GT707475 \$23.95

NEEDLE FILE SET

A set of 6 precision files made to meet the exacting standards of die makers, instrument makers, jewelers, watchmakers, and other craftspeople. Each set contains 1 each of: Equaling, Half Round, Flat, Round, Square, and Three Square (Triangular) Swiss Pattern Files. Comes packed in a durable vinyl case. Overall length of each file is 5-1/2”.



\$475 (Economy 12 pcs) \$20.95

DIAMOND-COATED FILES



8047



8042

Super-hard diamond coated round files will clean your smallest connectors like a pro.

8047 (Flexible Flat Files) \$29.95
8042 (Micro Round) \$38.95

FILE SET



A set of 5 of the most commonly used files packaged together in one kit for extra savings. Included are one each of: 8” triangular bastard, 10” half-round bastard, 10” flat mill, 10” square bastard, and 10” round (rat-tail) bastard. This set also includes file handles for each file and a file card to keep them clean.

FILE-KIT1 \$65.95



BOOKS AND SOFTWARE



FAA AC43.13 ACCEPTABLE METHODS, TECHNIQUES, AND PRACTICES

The FAA's AC43.13 provides a wealth of information pertaining to the inspection and general maintenance of airplanes. In it, you'll find charts and tables, identification and marking conventions; and maintenance standards. Compliance with the standards set forth in AC43.13 is not optional - it's mandatory.

AC4313\$26.95

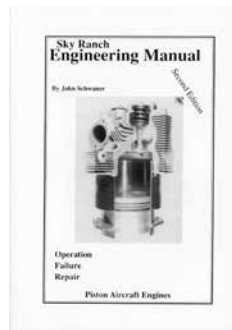

SKY RANCH ENGINEERING MANUAL

John Schwaner authors one of the most definitive manuals on aircraft engine maintenance we've ever seen. His book takes you from the basics up to the arcane art of engine diagnostics. He covers factors such as lubrication, electrical issues, mechanical alignment, heat related problems, vibration and balance, etc. The chapter on troubleshooting alone is worth it's weight in gold.

SREM1\$23.95

AVIATION MAINTENANCE TECHNICIAN SERIES



The first book of Dale Crane's AMT Series, Covers the first section of the FAA's required curriculum, an introduction to aviation along with basic lessons on mathematics, physics, and electricity. Also addressed are regulations, mechanic privileges, forms, aircraft hardware and tools.

- AMT-G3H(General).....\$59.95
- ASA-8083-30(General Handbook).....\$39.95
- AMT-STRUC-3H(Structure).....\$49.95
- AMT-P3(Powerplant)\$59.95

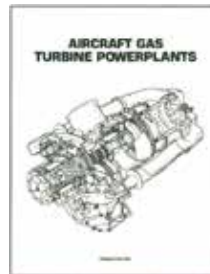

AIRCRAFT GAS TURBINE POWERPLANTS

The most up-to-date information on aircraft gas turbine powerplants available. New edition features over 450 pages and 500 illustrations.

EA-TEP-2.....\$65.95



ESSENTIALS OF ADVANCED COMPOSITE FABRICATION AND REPAIR

An excellent resource for beginners and professionals alike. It teaches concepts and methods in a direct manner for a wide array of composites including fiber and matrix selection, curing and achieving desired properties, testing and inspection, with step-by-step instructions and troubleshooting.

ASA-COMPOSITE\$79.95



FAR/AIM FAR AERONAUTICAL INFORMATION MANUAL

Contains Titles 14 and 49 of the Code of Federal Regulations (14 and 49 CFR) pertinent to General Aviation, Sport Pilots and Flight Instructors, combined with the Aeronautical Information Manual (AIM) (includes Change 3, effective 8/25/2011).

FAR-AIM.....\$17.95



HELICOPTER MAINTENANCE

Written in concise, simple language and packed with photos and illustrations, this text explains the eight major helicopter types and how their systems operate. Combined with its companion study guide, this text provides "rotary-wing" excellence.

EA-HF-2.....(Textbook)\$35.95



AVIATION MECHANIC HANDBOOK

Dale Crane's handbook has been considered "The Aviation Standard" for many years. A core reference manual for mechanics, aircraft owners, and pilots, it compiles specs from reference books and government pubs into a handy guide. Your single source for: conversions, formulas, aircraft nomenclature, material/tool identifications, hardware sizes/equivalents, and much more.

ASA-MHB-6\$16.95

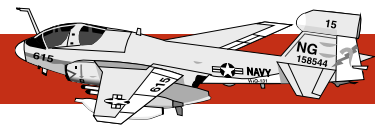

AVIATION LOGBOOKS



These logbooks are designed to help keep your aircraft records in order: inspections, tests, repairs, alterations, ADs, service bulletins, and equipment additions, removals or exchanges can all be documented in accordance with FAA requirements.

PART	DESCRIPTION	PRICE
ASA-SP-L	Propeller Logbook	\$4.95
ASA-SA-V2	Avionics Logbook	\$7.95
ASA-SE-1	Soft Cover Engine Logbook	\$5.95
ASA-SE-2	Hard Cover Engine Logbook	\$12.95
ASA-SA-1	Soft Cover Aircraft Logbook	\$5.95
ASA-SA-2	Hard Cover Aircraft Logbook	\$12.95
ASA-SP-AMT	AMT Logbook	\$19.95

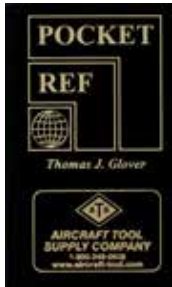

POCKET REFERENCE

- Do you stay up at night pondering what kind of electrical plugs they use in Western Ethiopia?
- Are your semaphore skills a little rusty?
- And just how the heck do you tie a Crabber's Eye Knot, anyway?

If these and other such questions occupy your waking thoughts, then this is the book for you. The Pocket Reference is packed full of remarkably useful information. Inside you'll find tables for every conversion imaginable; US and international standards; weights and properties of materials, and much more. Get a copy of this book and you'll never lack the answer to life's nagging questions again.

POCKETREF \$11.95

AMT HANDBOOK: AIRFRAME



This FAA AMT Handbook—Airframe Volume 2 is one of two volumes that replace and supersede Advisory Circular (AC) 65-15A. Completely revised and updated, this handbook reflects current operating procedures, regulations, and equipment.

ASA-8083-31V1(Volume 1)..... \$30.95

ASA-8083-31V2(Volume 2)..... \$30.95

AMT HANDBOOK: POWERPLANT



FAA handbook provides knowledge for earning the Aviation Maintenance Technician certificate, Powerplant section. The FAA General test questions are drawn from this book (FAA-H-8083-32).

ASA-8083-32 \$30.95

27 YEARS OF THE RVATOR



Contains the complete collection of technical articles, builder assist articles, flying techniques articles, product evaluations, and safety and maintenance notices from Vans Aircraft from 1980 through 2006. 490 page paperback.

ATB9663BK..... \$26.95

FAR/AIM FOR AVIATION MAINTENANCE TECHNICIANS



Contains Titles 14 and 49 of the Code of Federal Regulations (14 and 49 CFR) pertinent to General Aviation, Sport Pilots and Flight Instructors, combined with the Aeronautical Information Manual (AIM) (includes Change 3, effective 8/25/2011).

FAR-AMT \$24.95

AIRCRAFT STRUCTURAL TECHNICIAN



This book was written as an A&P college textbook for an in-depth course on metal airframe structures, but is also well suited and highly recommended for builders of metal kitplanes such as the Van's RV series.

ATB0908 \$32.95

ORDERING INSTRUCTIONS

PRICING

We strive for total accuracy in the pricing and presentation of our products, however we have been known to make a mistake every now and then. Therefore, we reserve the right to make corrective changes to pricing and product descriptions without notice.

NO MINIMUM ORDER

No minimum order is required.

CUSTOMER INFORMATION

To help us process your order quickly, please verify that both your shipping and mailing addresses are correct. Also please be sure to give us your complete shipping address including street name and number, post office box (if any), postal or zip code, and country (if other than the United States). This will ensure that your order will be delivered without delay.

SHIPPING METHOD

Please indicate your preferred method of shipment and we will try our best to accommodate your request. Note however, that it may not be possible to deliver your package via the method you've specified if your chosen carrier does not deliver to your area. In such cases, we will send your order either via UPS or Mail depending on which carrier services your area.

If you choose to have your package delivered via UPS, then you must give us a physical street address. UPS cannot deliver to a post office box, or to an FPO/APO address.

Unless you request a different service, domestic orders are shipped by UPS ground and international orders are shipped via UPS Worldwide. Priority delivery is also available. Please see our order form for options.

However you choose to send your order, we will usually process it and send it out the same day if we receive it before 4 p.m. (EST) -- and if there are no backorders. If your order contains backordered items, we will send you a partial shipment, or hold your order until it's complete if the backordered items are expected to arrive shortly.

ORDER LINE ITEMS

Please give us the part number, description, and quantity of the items you would like to purchase. And note that some items such as piloted reamers will require that you specify a size in addition to the part number. Use the description area to specify sizes whenever it's needed; and please feel free to continue your order on a blank sheet of paper if there isn't enough space on the order form.

Use the Special Instructions area to provide additional instructions regarding your order.

Michigan residents please remember to add 6% sales tax if you are an end-user. If you are a Michigan business with a valid tax ID number, then please include it so that we can exempt your order from sales tax.

PAYMENT METHOD

You may pay for your order with a Visa, MasterCard, Discover/Novus or American Express credit card by writing the card number, its expiration date, and your signature in the space provided on the order form.

You may also make payment by sending us a check or money order with your order. However, please note that we reserve the right to hold personal checks until they are cleared by the bank, which might take up to 5 business days.

If you are purchasing for a government organization, a school, or a company that has an open account with us, you may execute the order by writing your purchase order number in the space provided on the order form. We will then process your order and send you a copy of the invoice for payment. Our payment terms for all accounts is net 30 days.

SENDING YOUR ORDER

Please take a moment to review your order before sending it. In particular, verify that your shipping and mailing addresses are correct, and that you've entered your payment information correctly. Also, don't forget to include a telephone number where you can be reached during business hours so that

we may contact you if there is a problem with your order.

- The fastest way of placing your order is by calling our order desk at **1-800-248-0638** (United States and Canada only) and one of our sales clerks will gladly take your order. International customers may reach our order desk by calling **USA+989-739-1447**.
- Placing your order from our online e-commerce site is also extremely fast and efficient. It's located at **www.aircraft-tool.com** and there you'll find a complete shopping system that lets you order with ease at anytime, and from anywhere. You can also order by e-mailing **sales@aircraft-tool.com**, and it will be processed as soon as we receive it. When e-mailing, please remember to include a return e-mail address so that we can contact you.
- The fax number to our order desk is **1-989-739-1448**, and it's available 24 hours a day.
- And finally, you can mail your order to us at:

Aircraft Tool Supply Company
P.O. Box 370
Oscoda, Michigan 48750

CUSTOMER SERVICE

Our customer service representative is there to help you with your service needs. If you have a problem with your order or tools, please feel free to give our representative a call. We are always pleased to quote price and availability on any item we sell. You may be assured of prompt and individual attention.

RETURNING MERCHANDISE

You may return any unused item within **30 days** for a full refund or exchange. A 20% restocking fee will be charged for special order items. When returning an item, please send a copy of your invoice and state the nature of the problem (defective, ordered in error, etc) and what you would like us to do to resolve it. Return items properly packaged and **PREPAY** shipping charges. Do not return your merchandise COD, our receiving department cannot accept these shipments.

REPAIR SERVICE

Items requiring repair and no longer covered by our warranty may be returned to our repair department. Please include your complete address, email, and a telephone number at which you may be reached during the daytime. State the nature of the problem clearly. Please indicate if you require an estimate before repair. Enclose payment information to cover the cost.

WARRANTY

Aircraft Tool Supply (ATS) warrants the original purchaser or, for products purchased from a Reseller, to the original end-user that ATS branded products will be free from defects in materials and workmanship from the date of shipment for 1 year from the date of shipment or invoice, or in the case of ATS PRO branded products, the serviceable lifetime of the product. During the warranty period, ATS will, at its option: (1) provide replacement parts necessary to repair the product, (2) replace the product with a comparable product, (3) refund the amount you paid for the product, LESS DEPRECIATION, upon its return. ATS will provide labor to resolve warranty issues. To obtain service under this limited warranty, you must follow our warranty procedures. If we ask you to return a defective product or part, you must do so within 7 days after you receive the replacement part or product. ATS will charge you for replacement parts or products if you fail to do so. If you are domestic U.S. customer who purchased a product directly from ATS, we will arrange to ship replacement parts or products to and from you, and will pay the return shipping costs. If you live outside the United States, then you must pay shipping and applicable duty costs from and to your destination.

THIS LIMITED WARRANTY COVERS NORMAL USE. ATS DOES NOT WARRANT AND IS NOT RESPONSIBLE FOR DAMAGES CAUSED BY MISUSE, ABUSE, ACCIDENTS, UNAUTHORIZED SERVICE OR PARTS, OR THE COMBINATION OF ATS BRANDED PRODUCTS WITH OTHER PRODUCTS. THIS LIMITED WARRANTY DOES NOT COVER RECALIBRATIONS OR REGULAR MAINTENANCE. THIS LIMITED WARRANTY DOES NOT COVER NON-ATS BRANDED PRODUCTS. ANY WARRANTY APPLICABLE TO NON-ATS BRANDED PRODUCTS IS PROVIDED BY THE ORIGINAL MANUFACTURER.

Index

A

Adel Clamp Installer 145
 Air Couplers 150
 Aircraft Jacks
 Alpha Aviation 140
 Bottle Jacks 137
 Jack Pads 142
 Meyer TriTask 138, 139
 Air Drills 52, 53, 54
 Air Hose 150
 Air Line Connectors 150
 Aircloc Installation Tools 43
 Air Oiler 150
 Air Ratchet 158
 Air Regulators 15, 150
 Alignment Pins, Engine Mount 134
 Allen Wrenches. See Hex Wrenches
 Anti-Vibration Gloves 15
 Apex Bit Holders 165
 Arm Gloves 132

B

Back Rivet Plate 24
 Battery Chargers 100, 101
 Battery Terminal Tools 101
 Beading Kit 147
 Bearing Packer 131
 Bender Brakes 85, 86
 Bit Driver 164
 Bit Holder 166
 Bits 164
 Apex 165
 Holder 158
 Impact 164
 Torq 165
 Blind Riveters 35, 36, 37, 38, 39, 40, 41
 Blow Gun 154
 Boelube® 56
 Bolt Cutter 82
 Bolt Gauge 82
 Bolt Grip 167
 Bonding Brush 72
 Books 170, 171
 Borescopes 107, 108.
 Bossing Mallets 78
 Brake Bleeder Adapters 137, 141
 Brake Bleeder Tank 137
 Brake Relining Tools 26, 137
 Brass Peen 25
 Breaker Bar 161
 Bucking Bars 1
 Steel 21
 Tungsten 20
 Burnishing Tool 81
 Burrs, Carbide 69, 70

C

Cable Cutter 91
 Cable Gauges 90, 91
 Cable Swager 90, 91
 Cable Tensiometer 87

Cable Tester, Ignition 115
 Cable Thimbles & Sleeves 91
 Cable Tie Gun 165
 Cable & Wire Tools 87, 89, 90, 91
 Caliper, Precision 102
 Calipers & Dividers 103
 Calipers, Precision 102, 104
 Camloc Installation Tools 43, 44, 45
 Camloc Pliers 44
 Cannon Plug Pliers 98
 Carbide Burrs 69, 70
 Carbon Monoxide Detector 144
 Center Punch 56
 Champion Tools 123, 124
 Cherrymax® Rivets 16
 Cherry® Riveters 35, 36, 39
 Chip Chaser 65
 Clamps, Sheet Metal 42, 81
 ClampTite 89
 Cleaner
 Bug Blaster 75
 Simple Green 75
 Windshield 75
 Cleaning
 Brushes 74
 Cleco Fasteners 42
 Cleco Pliers 42
 Combination Squares 103
 Compression Riveters 29, 30, 31
 Control Lock 144
 Cotter Pin 167
 Counterbores, Aircraft 49
 Countersinks & Counterbores 1, 47, 48, 49
 Chatterless 48
 Crescent® Wrench 161
 Crimpers
 Deutsch 95
 Electrical Terminal 92, 93, 94, 95
 Lug 94
 Non-Insulated 94
 Sheet Metal 79
 Cross Check
 Dykem 143
 C-Squeezer Yokes 30
 Cable & Wire Tools 88
 Cut-Off Tool, Air 70, 158
 Cut-Off Wheels & Arbors 70
 Cutters
 Carbide 48
 Spotface 49
 Cutters, Electrical 92, 95
 Battery Cable 101
 Cyclo Polisher & Accessories 74
 Cylinder Base Wrenches 134
 Cylinder Bore Gauge 103

D

Deburring Tools 64, 81, 149
 Dental Picks 121
 Dial Indicators 103
 Diamond Points & Cutters 70
 Die Grinders 68
 Differential Pressure Testers 112
 Dimple Die Block Set 27
 Dimple Dies 26, 27, 28
 Avex Rivets 27
 Brake Rivets 26
 Camloc 45
 Dzus 45

Fuel Tank 27
 Spring Back 26, 27
 Dimple Die & Squeezer Set Holder 28, 32
 Dimpling Pliers 26, 27
 Dolly, Sheet Metal 78
 Drill Attachments 55
 Drill Bits 56, 63
 6" Aircraft Length 59
 12" Aircraft Extension 60
 Index 57
 Jobber Length 58
 Step Drill 63
 Threaded 61
 Drill Chuck
 Close Quarter 53
 Keyless 53
 Miniature 53
 Precision 53
 Drill Extension 65
 Drill Gauges 53
 Drill Guides 2
 Plate Nut 66
 Safety Wire 89
 Tube 66
 Drill Housing & Bushings 65
 Drilling Equipment 50-66
 Drills, Air 50, 51
 Drill Stops 53
 Duplicating/Transfer Punch 65
 Dzus Installation Tools 44, 45

E

Edge Marker 79
 Edge Rolling Tool 79
 Engine Assembly Pins 2
 Engine Calibration 113
 Engine Equipment 112-134
 Engine Protector, TopCap 133
 Engine Stand 133
 Engine Test Kit 4, 113
 Exhaust Stud Drill Guide 133
 Extend-A-Lube 166

F

Fabric Tester, Maule 76
 Fabric Tools 76, 77
 File Card 169
 File Handles 169
 Files 169
 Electrical 98
 Flanging Tool 79
 Air 83
 Hole 79
 Flaring Tools
 Push Rod 127
 Tube 148, 149
 Flashlights 109
 Flex Hone 132
 Fluid Drain Pan 154
 Fluting Pliers 81
 Fly Cutter 80
 Flying Wire Tensiometer 87
 Forceps 92
 Ford Wrench. See Crescent® Wrench
 Fuel Tester 144
 Funnel
 Form-A-Funnel 132
 Right Angle 154

G

Gasket Punch 77, 131
 Gauges
 Ball Hole 105
 Contour 105
 Feeler 105
 Radius 105
 Screw 105
 Sheet Metal & Wire 105
 Telescoping 105
 Graphics Removal 73
 Grease Gun 151, 153
 Grease Joint Rejuvenator 153
 Grinder 70
 Grip Gauge 18
 Grommet 2, 77
 Ground Power Plugs 100

H

Hammerless Punch 56
 Hammers
 Brass 163
 Dead Blow 163
 Sheet Metal 78
 Handee Clamp 167
 Hand Tools 159-169
 Heat Gun 155
 Digital 155
 Kit 155
 Propane 155
 Heat Shrink Tubes 155
 Heli-Coil® 111
 Hemostat 98
 Hex Bit Adapter, Threaded 165
 Hexnut Driver. *See* Wingnut/Hexnut Driver
 Hex Nut Fastener 43
 High Voltage Cable Tester 115
 Hi-Lok® Tools 46
 Hinge Bearing Kit 143
 Hi-Shear Tools 24
 Hole Cutter 82
 Hole Duplicators 64
 Hole Spotters 65
 Hollow Cutter 48
 Hose Assembly Tool 145
 Huck® Riveters 38

I

Ignition Harness Tool Kit, Slick 115

J

Jacks, Aircraft. *See* Aircraft Jacks
 Jet™ Sheet Metal Brakes & Shears 86
 Jilson Shears 84
 Jogging Tool, Sheet Metal 79

L

Lapping Compound 132
 Lead Thread Chaser 120
 Light
 Inspection 109
 Light Remover (WEMAC) 98

M

Magnaflux® 110
 Magnetic Field Indicator 110
 Magneto
 Locking Tool 114
 Synchronizers 114, 115
 Timer 114
 Magneto E-Gap Timing Kit 114
 Magneto Overhaul Tool Kit 115
 Magnets 108, 109
 Magnifier 109
 Manuals, Reference. *See* Books
 Master Orifice Tool 114
 Micro-Mesh™ 75
 Micrometers 102, 103
 Microstop Countersink 47
 Mini-Mixer 146
 Mirrors, Inspection 108, 109
 Monkey Wrench. *See* Crescent® Wrench
 Multimeter
 Analog 99
 Digital 99

N

Nibbler, Sheet Metal 84
 Nippers, Electrical. *See* Cutters, Electrical
 Nosepieces, Power Riveter. *See* Pulling Head, Riveter
 Notcher
 Tubing 84
 Nut Driver 98

O

Oil, Air Tool 15
 Oil Analysis Kit 113
 Oil Filter Cutter 122, 123, 128, 129
 Oil Filter Media Cutter 122, 128
 Oil Filters 125
 Oil Filter Wrench 123, 124, 129
 Oil Nut Wrench, Cessna 129
 Oil Seal Installer 127
 O-Ring 167

P

Paint Cutters 73
 Panel Beater & Dolly Kit 78
 Pickup Tools 109
 Pilot Cutters 47, 48
 Pilots 48
 Pin Extractor, Terminal 92
 Pin Insertion/Extraction Tool 92
 Pin Punches 163
 Piper Taper Pin Removal 143
 Piston Pin Removal Tool 122
 Piston Ring Compressor 130
 Piston Ring Groove Cleaner 130
 Piston Ring Installer 130
 Plastic Edge Scraper 56
 P-Lead Adapter, Magneto 114
 Plastic Cleaner. *See also* Window Cleaner
 Plexiglas® Drill Bits. *See* Plastic Drill Bits
 Pliers 168
 Cannon Plug 98
 Cleco 42
 Crimper 95
 Dimpling 26, 27
 Electrical 92
 Fluting 81

Line mans 95
 Screw Removal 168
 Snap Ring 168
 Point Sets
 Diamond 70
 Polish
 Aircraft 75
 Polisher
 Cyclo-5 74
 Power Riveters
 Cherry Textron® 35, 36
 Power Tools 158
 Precision Measuring Tools 102, 103, 104, 105
 Pressure Gauge, Tire 135
 Production Guns
 Paint 153, 154
 Sprayers 154
 PROGRABIT® 159
 Propeller Tachometer 106
 Protractor 104
 Digital 106
 Measuring 104
 Propeller 106
 Pulling Head, Riveter 36
 Punch 77
 Air 83
 Hand 77, 82
 Pin. *See* Pin Punches
 Punch And Flare Set 85
 Push Rod Flaring Tool 127
 Push Rod Spring Compressor 122, 127

R

Rapco Vacuum Pump Wrench 131
 Ratchets 161, 163
 Ratio Driver 164
 Reamers 62, 63
 Expansion 63
 Piloted 63
 Tapered Pin 63
 Remove Before Flight 144
 Control Lock 144
 Wheel Chocks 144
 Retainer Springs, Rivet Gun 15
 Rivenut Installers 1, 40, 41
 Rivenuts 41
 Rivet Cutters 18, 19
 Riveters
 Blind 37, 38, 39, 40
 Cherry® 35, 36
 Huck® 38
 Lockbolt 38
 Monobolt 38
 Riveters Tape 25
 Rivet Gauge 17
 Rivet Guns 12, 13, 14, 15
 Rivet Gun Shank Reducer 15
 Riveting Equipment 22, 23, 24, 25, 26, 27, 28
 Riveting Kits 5, 6, 7, 8, 9, 10, 11, 13, 14
 Rivet Puller 16, 40, 41
 Rivet Puller, Pneumatic. *See* Power Riveters
 Rivet Removal Tools 19
 Rivets
 Assortment Pack 18
 Brake Relining 137
 Cherrymax® 16
 "OOPS" NAS1097 18
 Solid AD 17, 18, 19
 Rivet Set Extension 24

Rivet Sets 2, 14, 22, 23, 24
 Semi-Tubular 23
 Rivet Shaver 48
 Rivet Spacing Tool 25
 Rivet Squeezer 2
 Hand Squeezers 33, 34
 Rivet Squeezer Accessories 29
 Rivet Squeezer Dies 26, 28
 Rivet Squeezer Kits 32, 33, 34
 Rivet Squeezer Yokes 33
 Rivet Trimmer 18
 Rod Bender 149
 Rod End Bearing 145
 Router Bits
 Aircraft 56
 Rules, Measuring 104

S

Safety Wire 1, 88
 Safety Wire Twisters 88, 89
 Sand Blaster 71
 Sanders 67
 Detail 71
 Orbital 67
 Saws
 Air 83
 Reciprocating 83
 Scales, Fish 143
 Scotch-Brite™ 72, 73
 Scrapers 81, 151
 Non-Marring 72
 Screw & Bolt Remover 159
 Screwdriver 2, 164
 Brass Compass 144
 Hand 164
 Torque 162
 Screw Extractors 159
 Screw-Grab® 159
 Screwdriver
 Air 158
 Screw Starters 165
 Scribe 82
 Seal
 Driver 131
 Puller 131
 Seal Installer 127
 Seal Remover
 Tach Drive 124
 Seal All Terminal Tool 99
 Sealant, Aviation Gasket 131
 Sealant Gun, Semco® 146
 Seamer-Hand, Sheet Metal 81
 Semco® Sealant Products 146
 Service & Support Equipment 135-151
 Shears 77
 Fabric 76
 Pinking 76
 Sheet Metal 76, 84, 86
 Sheet Metal Fasteners 42, 43, 44, 45
 Sheet Metal Tools 78-86
 Shop Equipment 152, 153, 154, 155, 156, 157
 Shot Bags 78
 Shrinker/Stretcher, Sheet Metal 85
 Skin Wedge 81
 Slappers, Hardwood 78
 Slapping Spoon 78
 Slick® Magneto Tools 115
 Snake Drill Attachment 55
 Snap Ring Pliers 168

Snips 80
 Fabric 76
 Sheetmetal 80
 Soldering Tools 96, 97
 Acid Brush 97
 Desoldering 97
 Helping Hands 97
 Soldering Iron 96
 Soldering Station 96
 Spark Plug Cleaner 121
 Abrasive 119
 Spark Plug Cleaner & Tester 118, 119
 Spark Plug Gap Gauge 124
 Spark Plug Gapper 120
 Spark Plug Gaskets 123
 Spark Plug Inspection Magnifier 121
 Spark Plug Lead Wrench 123
 Spark Plug Resistance Tester 122
 Spark Plugs 126
 Spark Plug Socket 121
 Spark Plug Thread Chaser 1, 120
 Spark Plug Thread Lubricant 121, 123
 Spark Plug Tray 121, 122, 124
 Spark Plug Vibrator Cleaner 121
 Speed Handle 165
 Spotcheck, Magnaflux® 110
 Spray Wand Cleaner 154
 Spring Hooks 98
 Squeezer Sets. See Rivet Squeezer Dies
 Squeezer Yokes 30
 SR Cutter 151
 Strap Duplicators 64
 Strut
 Coupler 135
 Filler 136
 Pump 135, 136
 Service Tool 135, 136
 Surface Prep 71
 Swagers 90, 91
 Swaging Machines 90

T

Tach Drive Seal Remover 124
 Tachometer, Propeller. See Propeller Tachometer
 Tap & Die Sets 166
 Tape Measure 104
 Tempest Tools 122
 Tensmith™ Brakes & Shears 86
 Tensiometer
 Cable 87
 Flying Wire 87
 Terminal Crimpers. See Crimpers, Electrical Terminal
 Test & Inspection Equipment 106 -110
 Thermometer, Infrared 109
 Thimbles, Oval & Stop Sleeves 91
 Threadclip 76
 3M Products 72, 73
 Tie Strap Gun. See Cable Tie Gun
 Time-Rite® 117
 Timing Indicator 115
 Tire Bead Breaker 141
 Tire Mount Lube 141
 Tire Pressure Gauge 135
 Tire & Wheel Balancer 141
 Titanium Snips & Cutters 76, 79, 168
 Tool and Parts Holder 157
 Air Tool Holder 156
 GRYPMAT 156
 Magnetic 156

Organizer 157
 Wrench Rack 156
 Toolboxes & Toolbags 157
 Tool Kit 160
 Tool Kit, Electronic 3, 93, 99
 Torque Screwdriver 106, 162
 Torque Wrenches 123, 129, 162
 Tow Bars
 142
 Transfer Pins 65
 Transfer Punch 65
 Trutach Digital Prop Tach 106
 Tube Beading Kit 147
 Tube Benders 148, 149
 Tube Cutters 145, 149
 Tube Notchers 84
 Turnbuckle Tool 88
 Tweezers 92

U

Ultrasonic Cleaners
 Branson 152
 Elmasonic 152
 Unibit 63

V

Vacuum Cleaner, Air 153
 Vacuum Gauge 131
 Vacuum Pump Wrench 131
 Vacuum Test Kit 132
 Valve Guide Flex Hones 132
 Valve Lappers 132
 Valve Spring Compressor 122, 127
 Valve Tappet Gauge 127
 Vise 157
 Vixen File. See Files

W

Wear Gauge
 Engine 143
 Flap Track 143
 Seat Rail 143
 Wingnut Fastener 43
 Wingnut/Hexnut Driver 43
 Wire Crimpers. See Crimpers, Electrical Terminal
 Wire Harness Spoon 98
 Wire Marker 99
 Wire Stripper 94, 95
 Wire Twister 88, 89
 Work Light 153
 Wrench 163
 Cessna Oil Nut 129
 Combination/Box End 160, 161
 Crowsfoot 160
 Cylinder Base 134
 Ford 161
 Hex. See Hex Wrenches
 Propeller 127
 Ratchet 160, 161
 Set 167
 Vacuum Pump 131

Z

Zyglo™ Test Kit, Magnaflux 110